



DEPARTMENT OF CIVIL ENGINEERING
2017-2018

PROJECT BATCH LIST

BATCH-1

S.No	H.T.No of students	Name of the students	Name of the Guide	Title of the project
1	15E35A0108	MOHAMEED NADEEM UDDIN	M.SAI KUMAR SAGAR	DESIGN AND ANALYSIS OF MULTISTORIED BUILDING USINGE-TABS
2	14E31A0105	ARIF ABDUL RAHAMAN AL KASERI		
3	14E31A0137	MOHD MOHIUDDIN FAIZ		
4	14E31A0134	MOHD ABDUL RAQDF		

BATCH -2

5	14E31A0103	A.NEELIMA	M.SARITHA	LIFT SYSTEM MEDI GADDA BARAGE TO ANNARAM BARAGE THROUGH PUMP HOUSE
6	14E31A0106	A.AIYA LAKSHIMI		
7	14E31A0111	B.SHRUTHI		
8	14E31A0142	P.SHASHI KIRAN		
9	14E31A0159	V.AVINASH		

BATCH -3

9	14E31A0152	SYED MOHD FIRDOUSE	MD RESHMA	ANALYSIS OF BITUMNEOUS ROAD FAILURE CAUSES AND PREVENTION
10	14E31A0154	SYED NUMAN		
11	14E31A0134	MOHD JAWAD UDDIN		
12	14E31A0147	SHAIK RAHIL FARAZ		

BATCH-4

13	14E31A0113	CH OM PRAKASH	DR.K.S.S.S.N. REDDY	A CIVIL ENGINEERING APP- DREAM HOUSE LET'S DREAM COME TRUE
14	14E31A0104	ANRITHI KUMAR TIWARI		
15	14E31A0127	K.HIKSHI REDDY		
16	14E31A0107	B ANUJI KUMAR		

BATCH-5

17	14E31A0121	J.SAI KRISHNA	K.SAI PRADEEP	PRECAST AND PRESTRESSED CONCRETE TECHNOLOGY
18	14E31A0145	SAYYAD SOHEL		
19	14E31A0144	REHANE NDRA BABU		



20	14E31A0120	I PAVAN KUMAR		
BATCH-6				
21	14E31A0156	V SANTHOSH VARMA	B VARA LAXMI	CEMENT CONCRETE ROAD WITH MANUFACTURED SAND
22	14E31A0125	M SANDEEP		
23	14E31A0101	A SRIKANTH		
24	15E35A0112	V KAVITHA		
BATCH-7				
25	14E31A0139	N AISHWARYA	CH HEMALATHA	DESIGN AND CONSTRUCTION OF HEAD QUARTERS OF HYDERABAD CITY POLICE COMMISSIONERATE
26	14E31A0123	M CHANDRA SHEKAR		
27	14E31A0148	S MADHUKAR		
28	14E31A0116	G SHIVA KRISHNA		
BATCH-8				
29	15E35A0107	M SAGAR REDDY	B RAJASEKHAR	SELF COMPACTING OF CONCRETE WITH MAGNETIC WATER
30	15E35A0103	B RAGHURAM		
31	14E31A0109	B PRASHANTH		
32	14E31A0118	G SHRAVAN		
BATCH-9				
33	14E31A0117	G SUHRUDH	P ANIL	PARTIAL REPLACEMENT OF COARSE AGGREGATE WITH CRUSHED TILES IN CONCRETE
34	15E35A0104	G RATHNA KUMAR		
35	15E35A0105	K VENKATA KRISHNA		
36	15E35A0102	B SAI KRISHNA		
BATCH-10				
37	14E31A0149	S SRILATHA	B RAMANA KUMAR	PLANNING AND DESIGNING OF G PLUS 5 COMMERCIAL BUILDING
38	15E35A0101	ALTAJ AHMED		
39	15E35A0106	MOJIB		
40	13E31A0107	ABDUL RAHMAN BIN HASSAN AL YAFAI		
BATCH-11				
41	14E31A0157	VAISHNAVI UPADHAY	B BINCEMAL	MINI WATERSHED ANALYSIS FOR SUSTAINABLE DEVELOPMENT USING REMOTE SENSING AND GIS A CASE STUDY ON TORJUR WATERSHED
42	14E31A0155	SYED SAAD SHARIF		
43	14E31A0150	SYED ISMAIL		
44	14E31A0136	MOHD IBRAHIM TAJIBUL		



BATCH-12				
45	14E31A0151	SYED KALEEM ULLAH QUADRI	G ARUNA	DESIGN OF LIGHT WEIGHT BRIDGE
46	14E31A0112	B KIRAN KUMAR		
47	14E31A0124	MASARATH JAHAN		
48	14E31A0127	M LIKHITHA		
BATCH-13				
49	14E31A0129	MOHD AIRAZ MOHIUDDIN	B RAMANA KUMAR	CONSTRUCTION PROJECT MANAGEMENT OF MULTI STORED BUILDING
50	14E31A0129	MOHD ASIM SULEMAN		
51	14E31A0130	MIR SIDDIQ MUGTADIR		
52	14E31A0126	SYED MUSTAFA ALI		
BATCH-14				
53	14E31A0119	G TEJASWEI	M SRUJAN TEJA	USE OF WASTE PLASTIC IN BITUMEN ROAD MIX
54	14E31A0140	N THIRUPATHI		
55	14E31A0114	E ONIPRAKASH		
56	13E31A0105	A RAJ KUMAR		
BATCH-15				
57	15E35A0109	N SHESHU YARDHAN REDDY	CH SWETHAMBER	STUDY ON CONCRETE WITH PARTIAL REPLACEMENT OF CEMENT BY SUGARCANE BAGASSE ASH
58	15E35A0110	N VEEBA HANMANATHA RAO		
59	14E31A0141	P SRIRANTH REDDY		
60	14E31A0128	M ROHITH		
BATCH-16				
61	13E31A0138	M SANTHOSH	DR M VASANTHA LAXMI	REUSE OF PLASTIC BOTTLES AS A CONSTRUCTION MATERIAL
62	13E31A0113	D ROHIT		
63	14E31A0108	B VINAY		
64	14E31A0115	FAIZAN BAIG		

[Signature]
HOD

[Signature]
PRINCIPAL
MAHAVEER
 INSTITUTE OF SCIENCE & TECHNOLOGY
 Bandlaguda, Hyd-500 005.

MAHAVEER INSTITUTE OF SCIENCE AND TECHNOLOGY

Approved by AICTE, Affiliated to JNTU- Hyderabad

Vyasapuri, Bandlaguda, Post Keshavagiri, Hyderabad-500005

Department of Civil Engineering



ESTD : 2001

CERTIFICATE

This is to Certify that this project report entitled "DESIGN AND ANALYSIS OF MULTISTOREY BUILDING BY USING E-TAB" being submitted by AREF AL KASERI-14E31A0105, MOHD ABDUL RAOOF-14E31A0134, MOHD MOHIUDDIN FAIZ-14E31A0137, MOHAMMAD NADEEMUDDIN-15E35A0108. in IV II semester Civil Engineering is a record bonafide work carried out by them. The results embodied in this report have not been submitted to any other university for the award of any degree.

M.SAI KUMAR SAGAR

INTERNAL GUIDE

Assistant professor

EXTERNAL EXAMINER



C.H.SWETHAMBER

HEAD OF DEPARTMENT



PRINCIPAL

PRINCIPAL
MAHAVEER
INSTITUTE OF SCIENCE & TECHNOLOGY
Bandlaguda, Hyd-500 005.

MAHAVEER INSTITUTE OF SCIENCE & TECHNOLOGY

Approved by AICTE, affiliated to JNTU-Hyderabad, Vyasapuri,
Bandlaguda, POST keshavgiri (p.o), Hyderabad-500005

Department Of Civil Engineering



ESTD : 2001

CERTIFICATE

This to certify that major project entitled "KALESHWARAM PROJECT-LIFT SYSTEM FROM MEDIGADDA BARRAGE TO ANNRAM BARRAGE THROUGH PUMP HOUSE" submitted by A.NEELIMA - 14E31A0103, A.AJAYA LAKSHMI - 14E31A0106, B.SHRUTHI RAO - 14E31A0111, P.SHASHI KIRAN - 14E31A0142, V.AVINASHI - 14E31A0159 in partial fulfillment of the requirements for the award of the Degree of Bachelor of Technology in civil Engineering. To the JawaharlalNehru Technology University as a record bonafide work done by them under our supervision and guidance.

INTERNAL GUIDE

M. SARITHA
Asst. Professor



EXTERNAL EXAMINER

PRINCIPAL

Dr. K.S.S.N.Reddy



PRINCIPAL
MAHAVEER
INSTITUTE OF SCIENCE & TECHNOLOGY
Bandlaguda, Hyd-500 005.

MAHAVEER INSTITUTE OF SCIENCE AND TECHNOLOGY
(Approved by AICTE, affiliated to Jawaharlal Nehru Technology university)
Vyasapuri, Bandlaguda, post keshavagiri (P.O), Hyderabad-500005.

Department of civil engineering



ESTD: 2001

CERTIFICATE

This is to certify that the MAJOR PROJECT report titled "ANALYSIS OF BITUMINOUS ROAD FAILURES, CAUSES AND PREVENTION" is being submitted by SYED MOHAMMAD FIRDOUSE, SYED NUMAN, SHAIK RAHEL FARAZ, MOHD JAWAD, Bearing roll No.14E31A0152, 14E31A0154, 14E31A0147, 14E31A0131 respectively in partial fulfillment of the requirements for the award of the Degree of Bachelor of Technology in civil engineering. To the Jawaharlal Nehru Technology University as a record bonafide work done by them under our supervision and guidance.

INTERNAL GUIDE

MD. RESHMA SULTANA

Assistant professor

EXTERNAL EXAMINER



PRINCIPAL
MAHAVEER
INSTITUTE OF SCIENCE & TECHNOLOGY
Bandlaguda, Hyd-500 005,

MAHAVEER INSTITUTE OF SCIENCE & TECHNOLOGY

BANDLAGUDA, HYDERABAD-500 005

2014-2018

Department Of Civil Engineering



ESTD : 2001

CERTIFICATE

This to certify that major project entitled "DREAM HOUSE APPLICATION" submitted by ANKITH KUMAR TIWARI-14E31A0104, BARUN KUMAR-14E31A0107, CHLOMPRAKASH-14E31A0113, K.NIKHIL REDDY-14E31A0122 in partial fulfillment of the requirements for the award of the Degree of Bachelor of Technology in civil Engineering, To the Jawaharlal Nehru Technology University as a record bonafide work done by them under our supervision and guidance.

K.S.S.S.N.Reddy
INTERNAL GUIDE

Dr. K.S.S.S.N.Reddy
Professor

Srinivas
EXTERNAL EXAMINER



PRINCIPAL

Dr. K.S.S.S.N.Reddy



K.S.S.S.N.Reddy
PRINCIPAL
MAHAVEER
INSTITUTE OF SCIENCE & TECHNOLOGY
Bandlaguda, Hyd-500 005.

MAHAVEER INSTITUTE OF SCIENCE AND TECHNOLOGY

(Affiliated to Jawaharlal Nehru Technological University)

Vyasapuri, Bandlaguda, POST Keshavagiri(P.O), Hyderabad-500005

Department of civil engineering



ESTD : 2001

CERTIFICATE

This is to certify that the project report title "PRECAST & PRESTRESSED CONCRETE TECHNOLOGY" is being submitted by LPAVAN KUMAR, JSAI KRISHNA, R.NARENDRA BABU, SAYYAD SOHEL, bearing roll number 14E31A0120, 14E31A0121, 14E31A0144, 14E31A0145, in B. Tech IV II semester CIVIL ENGINEERING is a record bonafide work carried out by them. The results embodied in this report have not been submitted to any other University for the award of any degree.

INTERNAL GUIDE

K. SAI PRADEEP

(Assistant professor)

EXTERNAL GUIDE



HEAD OF DEPARTMENT

CH. SWETHAMBERI



PRINCIPAL
MAHAVEER
INSTITUTE OF SCIENCE & TECHNOLOGY
Bandlaguda, Hyd-500 005

MAHAVEER INSTITUTE OF SCIENCE & TECHNOLOGY

Approved by AICTE, affiliated to JNTU-Hyderabad,

Vyasapuri, Bandlaguda, POST Keshavnagar, Hyderabad-500005

Department of Civil Engineering



ESTD : 2001

BONAFIDE CERTIFICATE

This is certify that the project on "CEMENT CONCRETE ROAD WITH MANUFACTURED SAND" submitted by, A.SRIKANTH, M.SANDEEP, V.SANTHOSHVARMA, V.KAVITHA bearing Hall ticket number 14E31A0101, 14E31A0125, 14E31A0158, 15E35A0112 in partial fulfillment of the requirements for the award of the Degree of Bachelor of Technology in Civil Engineering. To the Jawaharlal Nehru Technological University as a record of bonafide work done by him under our supervision and guidance.

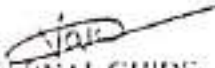
INTERNAL GUIDE

H. VARA LAXMI
(Assistant professor)

HEAD OF DEPARTMENT
CIVIL ENGINEERING

C. S. CHAMAR

EXTERNAL GUIDE

Srinivas



PRINCIPAL
MAHAVEER

2023/08/15

MAHAVEER INSTITUTE OF SCIENCE & TECHNOLOGY

(Affiliated to Jawaharlal Nehru Technological University)

Vyasapuri, Bandlaguda, POST Keshavgi (P.O), Hyderabad-500005

Department of civil engineering



ESTD : 2001

CERTIFICATE

This is to certify that the project report title "DESIGN AND CONSTRUCTION OF HEAD QUARTERS OF HYDERABAD CITY POLICE COMMISSIONERATE" is being submitted by G.SHIVA KRISHNA, M.CHANDRA SHEKHAR, N.AISHWARYA, S.MADHUKAR bearing Hall ticket numbers 14E31A0116, 14E31A0123, 14E31A0139, 14E31A0148 in B. Tech IV Year II semester CIVIL ENGINEERING is a record bonafide work carried out by them. The results embodied in this report have not been submitted to any other University for the award of any degree.

INTERNAL GUIDE

CH.HEMALATHA

Assistant professor

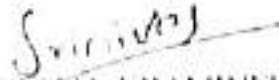
EXTERNAL EXAMINER



PRINCIPAL
MAHAVEER
INSTITUTE OF SCIENCE & TECHNOLOGY
Bandlaguda, Hyd-500 005.

MAHAVEER INSTITUTE OF SCIENCE & TECHNOLOGY
BANDLAGUDA, HYDERABAD-500 005

2014-2018

Department Of Civil Engineering



ESTD : 2001

CERTIFICATE

This to certify that major project entitled "SELF COMPACTING CONCRETE WITH MAGNETIC WATER" submitted by B.PRASHANTH(14E31A0109), G.SHRAVANI(14E31A0119), B.RAGHU RAM(15E35A0103), M.SAGAR REDDY(15E35A0107) in partial fulfillment of the requirements for the award of the Degree of Bachelor of Technology in civil Engineering, To the Jawaharlal Nehru Technology University as a record benefide work done by them under our supervision and guidance.

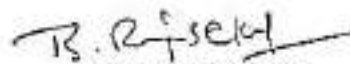
INTERNAL GUIDE

B.RAJASEKHAR
Asst. Professor

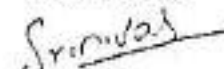
EXTERNAL EXAMINER

HEAD OF DEPARTMENT

CILSWETHAMBER

PRINCIPAL

Dr. K.S.S.S.N.Reddy



PRINCIPAL
MAHAVEER
INSTITUTE OF SCIENCE & TECHNOLOGY
Bandlaguda, Hyd-500 005.

MAHAVEER INSTITUTE OF SCIENCE & TECHNOLOGY

BANDLAGUDA, HYDERABAD-500 005

2014-2018

Department Of Civil Engineering



ESTD : 2001



CERTIFICATE

This is to certify that major project entitled "PARTIAL REPLACEMENT OF COARSE AGGREGATE WITH CERAMIC TILES IN CONCRETE" submitted by G.SUHRUDH -14E31A0117, B.SAI KRISHINA -15E35A0102, G.RATHNA KUMAR -15E35A0104, K.VENKATA KRISHINA-15E35A0105 in partial fulfillment of the requirements for the award of the Degree of Bachelor of Technology in civil Engineering. To the Jawaharlal Nehru Technology University as a record bonafide work done by them under our supervision and guidance.

INTERNAL GUIDE

P.ANIL
Asst.Professor

EXTERNAL EXAMINER

HEAD OF DEPARTMENT
CH.SWETHA CHAMBER

PRINCIPAL

Dr. K.S.S.S.N.Reddy

PRINCIPAL
MAHAVEER
INSTITUTE OF SCIENCE & TECHNOLOGY
Bandlaguda, Hyd-500 005.

MAHAVEER INSTITUTE OF SCIENCE AND
TECHNOLOGY

(Affiliated to Jawaharlal Nehru Technological University)

Vyasapuri, Bandlaguda, POST Keshavngiri(P.O), Hyderabad-
500005

Department of civil engineering



ESTD : 2001

CERTIFICATE

This is to certify that the project report title "" is being submitted by ABDUL REHMAN YAFAI, SOMA SRILATHA, ALTAH AHMED, MD JUNED bearing roll no 13E31A0102, 14E31A0149, 15E35A0101, 15E35A0106 in B-Tech IV- II semester CIVIL ENGINEERING is a record bona-fide work carried out by them. The results embodied in this report have not been submitted to any other University for the award of any degree.

INTERNAL GUIDE
(RAMANA KUMAR)
Assistant professor



EXTERNAL GUIDE



DEPARTMENT OF CIVIL ENGINEERING
MAHAVEER INSTITUTE OF SCIENCE AND TECHNOLOGY

(Affiliated to Jawaharlal Nehru Technological University)

Vyasapuri, Bandlaguda, POST Keslavagiri (P.O), Hyderabad-500005



ESTD : 2001

CERTIFICATE

This is to certify that the project report title "MINI WATERSHED ANALYSIS FOR SUSTAINABLE DEVELOPMENT USING REMOTE SENSING AND GIS - TORRUR WATERSHED Warangal District, Telangana" is being submitted by MOHAMMED IBRAHIM (14E31A0136), SYED ISMAIL, (14E31A0150), SYED SAAD SHAREEF (14E31A0155), VAISHNAVI UPADHYAY (14E31A0157), in B.Tech IV - II semester CIVIL ENGINEERING is a record bona fide work carried out by us. The results embodied in this report have not been submitted to any other University for the award of any degree.

INTERNAL GUIDE

(R. BHEEMAN)

Srinivas
EXTERNAL EXAMINER

HEAD OF THE DEPARTMENT

(G. SWETHAMBAR)



PRINCIPAL

(Dr. K.S.S.N. REDDY)



PRINCIPAL
MAHAVEER
INSTITUTE OF SCIENCE & TECHNOLOGY
Bandlaguda, Hyd-500 005.

MAHAVEER INSTITUTE OF SCIENCE & TECHNOLOGY

Vyasapuri, Bandlaguda, POST Keshavgi (P.O), Hyderabad-500005

2014-2018

Department of Civil Engineering



ESTD : 2001

CERTIFICATE

This is to certify that the project report title "DESIGN OF LIGHT WEIGHT BRIDGE" is being submitted by BKIRAN KUMAR, MASARATH JAIAN, M.LIKHITHA, SYED KALEEM ULLAH QUADRI bearing roll no 14E31A0112, 14E31A0124, 14E31A0127, 14E31A0151 in B-TECH IV-III semester CIVIL ENGINEERING is a record bona fide work carried out by them. The results embodied in this report have not been submitted to any other University for the award of any degree.

INTERNAL GUIDE

G. ARUNA

Assistant professor

HEAD OF DEPARTMENT
CH. SWETHAMBER

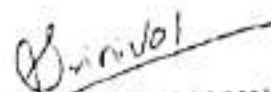

EXTERNAL EXAMINER

PRINCIPAL
MAHAVEER
INSTITUTE OF SCIENCE & TECHNOLOGY
Bandlaguda, Hyd-500 005.

MAHAVEER INSITITUTE OF SCIENCE AND TECHNOLOGY
(Approved by AICTE, affiliated to Jawaharlal Nehru Technology university)
Vyasapuri, bandlaguda, post keshavagiri (P.O), Hyderabad-500005.

Department of civil engineering



ESTD: 2001

CERTIFICATE

This is to certify that the MAJOR PROJECT report titled "CONSTRUCTION PROJECT MANAGEMENT " is being submitted by MOHAMMED AIRAJ MOHUDDIN, MIR MUQTADIR ALI HASHIMI, MOHAMMED ASIM SULEMAN, SYED MUSTAFA ALI Bearing roll No.14E31A0129, 14E31A0126, 14E31A0130, 14E31A0153 respectively in partial fulfillment of the requirements for the award of the Degree of Bachelor of Technology in civil engineering. To the Jawaharlal Nehru Technology University as of record bonafide work done by them under our supervision and guidance.

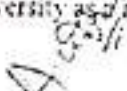
INTERNAL GUIDE

BRAMANA KUMAR

Assistant professor

HEAD OF DEPARTMENT

CH.SWETHAMBER

EXTERNAL EXAMINER



PRINCIPAL
MAHAVEER
INSTITUTE OF SCIENCE & TECHNOLOGY
Bandlaguda, Hyd-500 005.

MAHAVEER INSTITUTE OF SCIENCE & TECHNOLOGY

Approved by AICTE, Affiliated to JNTU-Hyderabad,
Vyasapuri, Bandlaguda, Post Keshavnigri, Hyderabad-500005

Department of Civil Engineering



ESTD : 2001

CERTIFICATE

This is certify that the MAJOR PROJECT on "USE OF WASTE PLASTIC IN BITUMINOUS ROAD MIX" submitted by A.RAJKUMAR, E.OMPRAKASH, G.TEJASWI, N.THIRUAPATHI bearing Hall ticket number 13E31A0105, 14E31A0114, 14E31A0119, 14E31A0140 in partial fulfillment of the requirements for the award of the Degree of Bachelor of Technology in Civil Engineering. To the Jawaharlal Nehru Technological University as a record of bonafide workdone by them under our supervision and guidance.

INTERNAL GUIDE

MSRUJAN TEJA

ASSISTANT PROFESSOR

EXTERNAL EXAMINER

HEAD OF DEPARTMENT
CHITSWETHA KUMAR



PRINCIPAL
MAHAVEER

MAHAVEER INSTITUTE OF SCIENCE & TECHNOLOGY
Bandlaguda, Hyd-500 005.

MAHAVEER INSTITUTE OF SCIENCE & TECHNOLOGY

BANDLAGUDA, HYDERABAD-500 005

2014-2018

Department Of Civil Engineering



ESTD : 2001

CERTIFICATE

This to certify that major project entitled "A STUDY ON CONCRETE WITH PARTIAL REPLACEMENT OF CEMENT BY SUGARCANE BAGASSE ASH" submitted by M.ROHITH-14E31A0128, P.SRIKANTH REDDY-14E31A0141, N.SHESHU VARDHAN REDDY-15E35A0109, N.YEERA HANUMANTHA RAO-15E35A0110 in partial fulfillment of the requirements for the award of the Degree of Bachelor of Technology in civil Engineering, To the Jawaharlal Nehru Technology University as a record bonafide work done by them under our supervision and guidance.

INTERNAL GUIDE
C.H.SWETHAMBER
HOD

EXTERNAL EXAMINER

PRINCIPAL
MAHAVEER
INSTITUTE OF SCIENCE & TECHNOLOGY
Bandlaguda, Hyd-500 005

MAHAVEER INSSTITUTE OF SCIENCE AND TECHNOLOGY
(Approved by AICTE, affiliated to Jawaharlal Nehru Technology university)
Vyasapuri, handlaguda, postkeshavagiri (P.O), Hyderabad-500005.
Department of civil engineering



ESTD : 2001

CERTIFICATE

This is to certify that the MAJOR PROJECT report titled "REUSE OF PLASTIC BOTTLES AS A CONSTRUCTION MATERIAL" is being submitted by **BATTHINI VINAY ,FAIZAN BAIG,MUSKU SANTOSH,DABBA ROHITH**, Bearing roll No.14E31A0108, 14E31A0115, 13E31A0138, 13E31A0113 respectively in partial fulfillment of the requirements for the award of the Degree of Bachelor of Technology in civil engineering To the Jawaharlal Nehru Technology University as a record bonafide work done by them under our supervision and guidance .

Laxmi

INTERNAL GUIDE
DILM VASANTHA LAXMI
Associate professor



Srinivas

EXTERNAL EXAMINER



Manjy

PRINCIPAL
MAHAVEER
INSTITUTE OF SCIENCE & TECH

MAHAVEER INSTITUTE OF SCIENCE AND TECHNOLOGY

EEE - MAIN PROJECT BATCHES (2014-2018)

BATCH NO.	ROLL NUMBER	NAMES OF BATCHMATES	TITLE	GUIDE
1	14E31A0205	Bhupathi Harika	GSM BASED MULTIPLE DEVICE CONTROL AND SMART HOME AUTOMATION	Dr.R.V. Amarnath
	14E31A0220	Puvvada Shailendra		
	14E31A0222	Pooja Solankar		
	15E35A0209	Tekkam Harish		
2	13E31A0215	Gaddam Rakesh	ZIGBEE BASED ENERGY SAVING SYSTEM IN SCHOOLS AND HOTELS	B. Satish
	15E35A0205	Gundagani Mahesh		
	15E35A0207	Katta Sai Krishna		
	15E35A0208	Tanveer Khan		
3	14E31A0203	Arekatla Poojitha Reddy	STREET LIGHT CONTROL SYSTEM	G. Prem Kumar
	14E31A0204	Bandi Bheeshma Reddy		
	14E31A0213	Losirlu Suresh Kumar		
	14E31A0227	Talluri Greeshma Chowdary		
4	14E31A0210	Enti Vinay Kumar Reddy	TIME BASED AUTOMATIC PLANT IRRIGATION SYSTEM	A. Mahesh Kumar
	14E31A0214	Maccha Sandeep		
	14E31A0225	SaiRam Bala Gaud		
	14E31A0226	Suthari Manoj Kumar		
5	14E31A0216	Mir Abdul Kareem Khan	WIFI BASED AUTOMATED HOME SECURITY SYSTEM	T. Ravi Babu
	14E31A0217	Mohammed Abdul Vakeel		
	14E31A0218	Mohammed Abrar		
	14E31A0219	Mohammed Yakub Pasha		
6	14E31A0201	Anantharam Sandeep Kumar	SPY ROBOT CIRCUIT USINF HC-05	S. Suresh
	14E31A0224	Somanaboina Raghu		
	14E31A0228	Varukolu Shekhar		
	15E35A0201	Agumamidi Sai Ram		
7	14E31A0202	Anyarambatla Anusha	INDUSTRIAL PARAMETERS MONITORING THROUGH IOT	Dr.R.V. Amarnath
	14E31A0215	Malloju Madhu		
	14E31A0223	Sapavath Anitha		
	15E35A0204	Dyavanapelli Rajkumar		
	14E31A0211	Kaluri Shravan Kumar		

K. S. S.

PRINCIPAL
MAHAVEER
 INSTITUTE OF SCIENCE & TECHNOLOGY
 Bandlaguda, Hyd-500 005.

MAHAVEER INSTITUTE OF SCIENCE AND TECHNOLOGY

(Approved by AICTE , Affiliated to JNTUH , Hyd)

vyasapur, Bandlaguda, Post:Keshavgi, Hyderabad-500005

DEPARTMENT OF ELECTRICAL & ELECTRONICS ENGINEERING



ESTD : 2001

CERTIFICATE

This is to certify the dissertation entitled "Street light control system" is a bonafide work done by T Greeshma Chowdary(14E31A0227), L Suresh Kumar(14E31A0213), A Poojitha Reddy(14E31A0203), B Bheeshma Reddy(14E31A0204) in partial fulfillment of the academic requirements for the award of the degree of Bachelor of Technology in Electrical and Electronics Engineering, submitted to the department of Electrical and Electronics Engineering, MAHAVEER INSTITUTE OF SCIENCE AND TECHNOLOGY Hyderabad during the period 2017-18.

Internal Guide

G PremKumar Reddy

Depart. of EEE.

External Examiner

HOD

Dr.R.V.Amarnath

Depart. of EEE.

PRINCIPAL
MAHAVEER

INSTITUTE OF SCIENCE & TECHNOLOGY
Bandlaguda, Hyd-500 005.

MAHAVEER INSTITUTE OF SCIENCE AND TECHNOLOGY

**DEPARTMENT OF
ELECTRICAL & ELECTRONICS ENGINEERING**
(Approved by AICTE, affiliated to JNTU-Hyderabad,) Vyasपुरi,
Bandlaguda, POST Keshavgiri (p.o), Hyderabad-500005
2014 - 2018



ESTD : 2001

CERTIFICATE

This is to certify the dissertation entitled " **HOME AUTOMATION USING
BLUETOOTH MODULE**" is a bonafide work done by **K. SHRAVAN KUMAR
(14E31A0211), RISHAV VERMA(14E31A0221), K.SAINATH(14E35A0202),
B.BHOOMESH (15E35A0202), J. VIJAY (15E35A0206),**
in partial fulfillment of the academic requirements for the award of the degree of
Bachelor of Technology in Electrical and Electronics Engineering, submitted to the
department of Electrical and Electronics Engineering,
MAHAVEER INSTITUTE OF SCIENCE AND TECHNOLOGY Hyderabad during
the period 2017-18.

K. Suresh
INTERNAL GUIDE
19/1/18

Mr. K. SURESH
M.Tech
Asst prof, EEE Dept

HEAD OF THE DEPARTMENT

R.V. Amarnath
Dr. R.V. AMARNATH
M.Tech, Ph.D
Prof & HOD, EEE

[Signature]
External Examiner

K. Suresh PAL
VEER
INSTITUTE OF SCIENCE & TECHNOLOGY
Bandlaguda, Hyd-500 005.

MAHAVEER INSTITUTE OF SCIENCE AND TECHNOLOGY

**DEPARTMENT OF
ELECTRICAL & ELECTRONICS ENGINEERING**
(Approved by AICTE, affiliated to JNTU-Hyderabad,) Vyasपुरi,
Bandlaguda, POST Keshavgi (p.o), Hyderabad-500005
2014 - 2018



ESTD : 2001

CERTIFICATE

This is to certify the dissertation entitled "HOME AUTOMATION USING BLUETOOTH MODULE" is a bonafide work done by **K. SHRAVAN KUMAR (14E31A0211)**, **RISHAV VERMA(14E31A0221)**, **K.SAINATH(14E35A0202)**, **B.BHOOMESH (15E35A0202)**, **J. VIJAY (15E35A0206)**, in partial fulfillment of the academic requirements for the award of the degree of Bachelor of Technology in Electrical and Electronics Engineering, submitted to the department of Electrical and Electronics Engineering, MAHAVEER INSTITUTE OF SCIENCE AND TECHNOLOGY Hyderabad during the period 2017-18.

K. Suresh
INTERNAL GUIDE
10/4/18

Mr. K. SURESH
M.Tech
Asst prof, EEE Dept

HEAD OF THE DEPARTMENT

R.V. Amarnath
Dr. R.V.AMARNATH
M.Tech, Ph.D
Prof & HOD, EEE

[Signature]
External Examiner

K. Suresh PAL
VEER
INSTITUTE OF SCIENCE & TECHNOLOGY
Bandlaguda, Hyd-500 005

MAHAVEER INSTITUTE OF SCIENCE AND TECHNOLOGY

(Approved by AICTE , Affiliated to JNTUH , Hyd)

Vyasapuri, Bandlaguda, Post: Keshavgiri, Hyderabad-500005

DEPARTMENT OF ELECTRICAL & ELECTRONICS ENGINEERING



ESTD : 2001

CERTIFICATE

This is to certify the dissertation entitled "TIME BASED AUTOMATIC PLANT IRRIGATION SYSTEM" is a bonafide work done by ENTI VINAY KUMAR REDDY (14E31A0210), MACCHA SANDEEP (14E31A0214), SRIRAM BALAGOUD (14E31A0225), SUTHARI MANOJ KUMAR (14E31A0226) in partial fulfillment of the academic requirements for the award of the degree of Bachelor of Technology in Electrical and Electronics Engineering, submitted to the department of Electrical and Electronics Engineering, MAHAVEER INSTITUTE OF SCIENCE AND TECHNOLOGY Hyderabad during the period 2017-18.

Internal Guide
A.Mahesh Kumar M.E
Asst. Professor
Dept. of EEE

External Examiner

HOD
Dr. R.V. Amarnath
Professor & Head
Dept. of EEE

PRINCIPAL
MAHAVEER
INSTITUTE OF SCIENCE & TECHNOLOGY
Bandlaguda, Hyd-500 005.

MAHAVEER INSTITUTE OF SCIENCE AND TECHNOLOGY

(Approved by AICTE , Affiliated to JNTUH , Hyd)
vyasapur, Bandlaguda, Post:Keshavgi, Hyderabad-500005

DEPARTMENT OF ELECTRICAL & ELECTRONICS ENGINEERING



ESTD : 2001

CERTIFICATE

This is to certify the dissertation entitled "Street light control system" is a bonafide work done by T Greeshma Chowdary(14E31A0227), L Suresh Kumar(14E31A0213), A Poojitha Reddy(14E31A0203), B Bheeshma Reddy(14E31A0204) in partial fulfillment of the academic requirements for the award of the degree of Bachelor of Technology in Electrical and Electronics Engineering, submitted to the department of Electrical and Electronics Engineering, MAHAVEER INSTITUTE OF SCIENCE AND TECHNOLOGY Hyderabad during the period 2017-18.

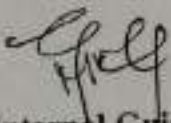
Internal Guide
G PremKumar Reddy
Depart. of EEE.

External Examiner

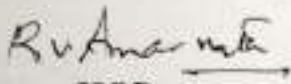
HOD

Dr.R.V.Amarnath
Depart. of EEE.

PRINCIPAL
MAHAVEER
INSTITUTE OF SCIENCE & TECHNOLOGY
Bandlaguda, Hyd-500 005.

DEPARTMENT OF ELECTRICAL & ELECTRONICS ENGINEERING
MAHAVEER INSTITUTE OF SCIENCE AND TECHNOLOGY

Vyasapuri, Bandlaguda, post. Keshavagiri, Hyderabad-05

Telangana

2017-2018

CERTIFICATE

Certified that this is a bonafied record of the dissertation work entitled, "GSM BASED MULTIPLE DEVICE CONTROL AND SMART HOME AUTOMATION" done by Bhupathi.Harika (H.No 14E31A0205), Puvvada.Shailendra (14E31A0220), S.Pooja (14E31A0222), T.Harish (15E35A0209) submitted to the faculty of Electrical & Electronics Engineering in partial fulfillment of the requirements for the Degree of BACHELOR OF TECHNOLOGY in ELECTRICAL AND ELECTRONICS ENGINEERING from Mahaveer Institute of Science and Technology, Bandlaguda, Hyderabad, Telangana-05.

R.v.Amarnath
INTERNAL GUIDE
Dr.R.V.AMARNATH

K. Suby

PRINCIPAL
MAHAVEER
INSTITUTE OF SCIENCE & TECHNOLOGY
Bandlaguda, Hyd-500 005,

R.v.Amarnath
HEAD. OF DEPARTMENT
Dr.R.V. AMARNATH

[Signature]
EXTERNAL EXAMINER

MAHAVEER INSTITUTE OF SCIENCE AND TECHNOLOGY

(Affiliated to JNTU, Hyderabad, Approved by AICTE)

Vyasapuri, Bandlaguda, Post: Keshavagiri, Hyderabad – 500005

DEPARTMENT OF ELECTRICAL & ELECTRONICS ENGINEERING



ESTD : 2001

CERTIFICATE

This is to certify that the project work entitled "SPY ROBOT CIRCUIT USING HC-05", which is being submitted by

1. A.SANDEEP KUMAR	14E31A0201
2. S.RAGHU	14E31A0224
3. V.SHEKHAR	14E31A0228
4. A. SAI RAM	15E35A0201

In partial fulfillment for the award of BACHELOR OF TECHNOLOGY in Electrical and Electronics Engineering, Mahaveer Institute of Science and Technology, approved by JNTUH, is a record of bonafide work carried out by him/her under our supervision.



S.SURESH M.Tech,
Asst. Professor
Dept. of EEE

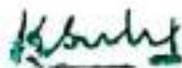

PRINCIPAL
MAHAVEER
INSTITUTE OF SCIENCE AND TECHNOLOGY
HYDERABAD (M)

(K.S.S.S.N REDDY)
PRINCIPAL

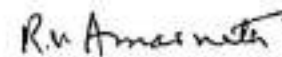

Dr.R.V. Amarnath M.Tech., Ph.D
Professor & Head
Dept. of EEE

MAHAVEER INSTITUTE OF SCIENCE AND TECHNOLOGY

(Approved by AICTE , Affiliated to JNTUH , Hyd)

Vyasapuri, Bandlaguda, Post: Keshavgi, Hyderabad-500005

DEPARTMENT OF ELECTRICAL & ELECTRONICS ENGINEERING



ESTD : 2001

CERTIFICATE

This is to certify the dissertation entitled "WIFI BASED AUTOMATED HOME SECURITY SYSTEM" is a bonafide work done by MIR ABDUL KAREEM KHAN (14E31A0216), MOHAMMED ABDUL VAKEEL (14E31A0217), MOHAMMED ABRAR (14E31A0218), MOHAMMED YAKUB PASHA (14E31A0219) in partial fulfillment of the academic requirements for the award of the degree of Bachelor of Technology in Electrical and Electronics Engineering, submitted to the department of Electrical and Electronics Engineering, MAHAVEER INSTITUTE OF SCIENCE AND TECHNOLOGY Hyderabad during the period 2017-18.

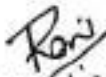
Internal Guide
T. Ravi Babu M.Tech
Asst. Professor
Dept. of EEE

PRINCIPAL
MAHAVEER
INSTITUTE OF SCIENCE & TECHNOLOGY
Vyasapuri, Bandlaguda, Hyderabad-500 005.
External Examiner

HOD
Dr. R.V. Amarnath
Professor & Head
Dept. of EEE

MAHAVEER INSTITUTE OF SCIENCE AND TECHNOLOGY



ESTD : 2001

DEPARTMENT OF ELECTRICAL AND ELECTRONICS ENGINEERING

CERTIFICATE

This is to certify that the major project report entitled "INDUSTRIAL PARAMETERS MONITORING THROUGH INTERNET OF THINGS" is a bonafide work of ANYARAMBATLA ANUSHA (14E31A0202), MALLOJU MADHU (14E31A0215), SAPAVATH ANITHA (14E31A0223), and DYAVANAPELLI RAJKUMAR (15E35A0204) of IV B.Tech-EEE II semester being submitted in partial fulfilment of the requirements for the award of B.Tech degree by JNTU, HYD. This work is carried out under my guidance during the academic year 2017-2018 and had not submitted anywhere else.

Project Guide:

R.V. Amarnath
(Dr.R.V.AMARNATH)

Head of the Department

Dept. of EEE

EXTERNAL EXAMINER

Head of the Department:

R.V. Amarnath
(Dr.R.V.AMARNATH)

Head of the Department

Dept of EEE

PRINCIPAL



(Dr.K.S.S.S.N.Reddy)

M.E, Ph.D, B.E, Civil Engineer

K.S.S.S.N.Reddy
PRINCIPAL
MAHAVEER
INSTITUTE OF SCIENCE & TECHNOLOGY
Bendlaguda, Hyd-500 005.

MAHAVEER INSTITUTE OF SCIENCE AND TECHNOLOGY

**DEPARTMENT OF
ELECTRICAL & ELECTRONICS ENGINEERING**
(Approved by AICTE, affiliated to JNTU-Hyderabad,) Vyasuri,
Bandlaguda, POST Keshavgiri (p.o), Hyderabad-500005
2014 - 2018



ESTD : 2001

CERTIFICATE

This is to certify the dissertation entitled "HOME AUTOMATION USING
BLUETOOTH MODULE" is a bonafide work done by **K. SHRAVAN KUMAR**
(14E31A0211), **RISHAV VERMA**(14E31A0221), **K.SAINATH**(14E35A0202),
B.BHOOMESH (15E35A0202), **J. VIJAY** (15E35A0206),
in partial fulfillment of the academic requirements for the award of the degree of
Bachelor of Technology in Electrical and Electronics Engineering, submitted to the
department of Electrical and Electronics Engineering,
MAHAVEER INSTITUTE OF SCIENCE AND TECHNOLOGY Hyderabad during
the period 2017-18.



INTERNAL GUIDE

Mr. K. SURESH
M.Tech
Asst prof, EEE Dept

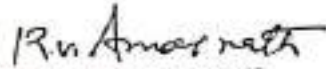

External Examiner

HEAD OF THE DEPARTMENT

Dr. R.V. AMARNATH
M.Tech, Ph.D
Prof & HOD, EEE

PRINCIPAL
MAHAVEER
INSTITUTE OF SCIENCE & TECHNOLOGY
Bandlaguda, Hyd-500 005.



DEPARTMENT OF MECHANICAL ENGINEERING

MAIN PROJECT LIST-2017-2018

BATCH NO	ILT. NO	STUDENT NAME	TITLE OF THE PROJECT	NAME OF THE GUIDE
1	14E31A0358	SYED MUZAMEEL ALI	FABRICATION & ASSEMBLY OF INTEGRATED 3D PRINTER WITH LASER ENGRAVER	B VENKATESHWAR REDDY
	14E31A0354	SHAIK MOHAMMED RAYAN		
	14E31A0340	MOHD AJAZ KHAN		
	14E31A0355	SHAIK SOHAIL		
2	14E31A0320	GOWLIKAR BHARGAV KUMAR	EXPERIMENTAL INVESTIGATION ON SS304 AND OHNS USING SPARK EROSION MACHINING	MD. SAJJAD
	14E31A0330	MADDIBOENA SIVAPRAGATHILAKSHMI		
	14E31A0325	KASOJU SAI KIRAN		
	14E31A0311	CHINTHIRALA NAGARJUNA		
	14E31A0322	JITENDRA SINGH		
3	14E31A0302	ANNAPU PUSHPANJALI	MAINTAINING STATE OF CHARGE (S.O.C) BATTERY USING REGENERATIVE BRAKING SYSTEM AND EDDY CURRENT BRAKING	B NAGESWAR
	14E31A0347	NEELI AKASH		
	14E31A0353	SHAIK AQIB		
	14E31A0319	GORIGE RAVIKANTH		



4	14E31A0360	VADLA PRASHANTH	DESIGN AND FABRICATION OF SHAFT DRIVEN BICYCLE	DESIGN AND FABRICATION OF SHAFT DRIVEN BICYCLE AUTOMOBILES
	14E31A0329	KUCHANPALLY SANTHOSH REDDY		
	14E31A0301	ALLI ARAVIND		
	14E31A0307	B VISHNU		
	14E31A0323	KATAPAAGA NIKHIL KALYAN		
5	14E31A0346	MUPPARAM SADHANA	HEXACOPTER WHICH CAN LIFT A LOAD OF 2KG	M. SONACHALAM
	14E31A0308	BALUSA VIVEK		
	14E31A0310	C SAI KIRAN		
	14E31A0314	DUSA YASHWANTH		
6	14E31A0306	B KISHORE	SOLAR POWERED STIRLING ENGINE	Dr. S. MURALI
	14E31A0321	JADALA VAMSHI KRISHNA		
	14E31A0318	GOPIDI ABHINAV REDDY		
	14E31A0309	BOTTU SAI MUKUND		
	14E31A0338	MOHAMMED KHAN		
7	14E31A0328	KOTTALA SUSHMITHA	FABRICATION OF SOLAR OPERATED PNEUMATIC RECIPROCATING WATER PUMPING SYSTEM	K. GANESHAN
	14E31A0317	GANGULA VINAY KUMAR		
	14E31A0331	MAMMAI AKHILESH		
	14E31A0316	ESUNATHI KALYAN		

Vysapuri, Bandlaguda Post Keshavnagar
Hyderabad-500 005, Telangana (INDIA)
Tel: 040-64596979, 20020773, Fax: 040-24455003
E-mail: principal.mahaveer@gmail.com,
Website: www.mist.ac.in

MAHAVEER

Approved by AICTE. Affiliated to JNTUH, Hyd



8	14E31A0349	PALATI RUKMANGADUDU	FABRICATION OF ADVANCED POWERED AUGMENTED ELECTRIC VECHICLE	T.SHAINSHA
	14E31A0343	MOTHAJIGARI VIJAY		
	14E31A0348	P. KRISHNA		
	14E31A0313	DUDUKA SHIVAKUMAR		
9	14E31A0326	KATAKAM VINODKUMAR	EXPERIMENTAL INVESTIGATION ON CUSTOM 456 AND ALUMINIUM H30 BY WIRE ELECTRIC DISCHARGE MACHINE(WEDM)	D. SANTHOSH KUMAR
	14E31A0315	EPPA RAGHU		
	14E31A0327	YAMINI SAI KUMAR		
	14E31A0333	MEDI AKHIL		
10	14E31A0383	MD MUQTAR AHMED KHAN	SOLAR ENERGY TO THERMAL REFRIGERATION USING PELTIER EFFECT	M.RAMDAS
	14E31A0391	N VINESH REDDY		
	14E31A0367	FAZAL AHMED KAMIL		
	14E31A0385	MOHAMMED OMER		
11	14E31A0361	AMIT KUMAR PANDEY	ELECTRO PERMANENT MAGNET BASED ANTENNA EJECTION MECHANISM	P HARI
	14E31A0372	GORIGE NARENDER		
	14E31A0387	MOHAMMED AKBAR		
	13E31A0380	FARAHANUDDIN		

Vysapuri, Bandlaguda Post Keshavnagar,
Hyderabad-500 005, Telangana INDIA
Tel: 040-64596979, 20020773, Fax: 040-24453003
E-mail: principal.mahaveer@gmail.com
Website: www.mist.ac.in

MAHAVEER



Approved by AICTE. Affiliated to JNTU, Hyd

12	14E31A0388	MOHD FAROOQ	FABRICATION OF FOUR ACTING POWER ACKSAW MACHINE BY USING SCOTCH YOKE MECHANISM	B.HARINATH REDDY
	14E31A0393	PITLA SWAMY		
	15E35A0308	SYED ASHFAQ		
	14E31A0384	MOHAMMED ABDUL RAHEMAN		
13	14E31A0392	NANDIGAM SURENDRA	DESIGN AND FABRICATION OF PNEUMATIC PEDAL BRAKING SYSTEM BY USING HAND CONTROLLED VALVES	G.K.SHANMUKH DEV
	14E31A03A3	SYED MD AHMED MOHIUDDIN QUADRI		
	14E31A0369	G RAGHUVERDHAN REDDY		
	14E31A0382	MA RAHEMAN		
14	14E31A0377	JAMALPUR ADITHYA	SEMI AUTOMATIC MATERIAL CARRIER FOR MINING AND TUNNELING APPLICATIONS	P DURGA RAVI PRASAD
	15E35A0302	H AKHILESH		
	15E35A0307	MYAKALA SHIVAKUMA		
	13E31A0318	C.VENKATESH		
15	14E31A0389	MOHD SOHAIL	FABRICATION OF THREE WAY MODERN PNEUMATIC TRAILER	S SUDHAKARA
	14E31A0380	KOPPULA NARESH REDDY		
	14E31A0396	RINJU GEORGE		
	14E31A03A2	SHEOB AHMED		

Vysapuri, Bandlaguda Post Keshavnagar,
Hyderabad-500 005, Telangana INDIA
Tel: 040-64596929,20020773, Fax: 040-24455003
E-mail: principal.mahaveer@gmail.com
Website: www.mist.ac.in

MAHAVEER



Approved by AICTE, Affiliated to JNTUH, Hyd

16	15E35A0305	MD SHOEIB AKRAM	FABRICATION OF FOOT STEP POWER GENERATION BY RACK AND PINION MECHANISM	SK AMEER
	15E35A0303	HEEREKAR RAHUL		
	14E31A0363	ARROJU SHRAVANKUMAR		
	14E31A0365	BOMMARAJU SAIKUMAR		
17	14E31A03A1	YERRA ARVIND REDDY	DESIGN AND FABRICATION OF HYDRAULIC BAR /TUBE BENDING MACHINE	N. SATISH KUMAR
	14E31A0378	KADAVENDI ARAVIND		
	14E31A03A0	VADLURI KRISHNA		
	15E35A0304	MAMIDIGA NAGESH		

**PRINCIPAL
MAHAVEER**
INSTITUTE OF SCIENCE & TECHNOLOGY
Bandlaguda, Hyd-500 005.

HOD

Dr.S.MURALI

DEPARTMENT OF MECHANICAL ENGINEERING

MAHAVEER INSTITUTE OF SCIENCE & TECHNOLOGY

Vyasapuri, Bandlaguda, Keshavagiri Post,

Hyderabad-500005.

DEPARTMENT OF MECHANICAL ENGINEERING



ESTD : 2001

CERTIFICATE

This is to certify that the Project work entitled "*FABRICATION & ASSEMBLY OF INTEGRATED 3D PRINTER WITH LASER ENGRAVER*" that is being submitted by Syed Muzameel Ali, Shaik Mohammed Rayan, Shaik Sohail, Mohammed Aijaz Khan in partial fulfilment of the requirement for the award of the Degree of Bachelor of Technology in MECHANICAL ENGINEERING from MAHAVEER INSTITUTE OF SCIENCE AND TECHNOLOGY, during the academic year 2017-2018.

The results embodied in this project report have not been submitted to any other University or Institute for the award of any degree.

~~Mr. B. VENKATESHWAR REDDY~~

Associate Professor

Project Guide

Dr.S.MURALI

Profession and Head of the Department

12/11/18
EXTERNAL EXAMINER
12/11/18
EXTERNAL EXAMINER

Vyasapuri, Bandlaguda, post: Keshavagiri
Hyderabad-500005 T.S. India
Tel: 040-24455001, 002,001, Fax: 010-244555001
Email: Info@mist.ac.in Web site: WWW.mist.ac.in



DEPARTMENT OF MECHANICAL ENGINEERING



CERTIFICATE

This is to certify that the project entitled "EXPERIMENTAL INVESTIGATION ON SS 304 AND OHNS BY USING SPARK EROSION MACHINING" submitted by G BHARGAV KUMAR, K SAI KIRAN, M. SHIVA PRAGATHI LAXMI, CH. NAGARJUNA, JITHENDAR SINGH in partial fulfillment for the degree of bachelor of technology in DEPARTMENT OF MECHANICAL ENGINEERING to the MAHAVEER INSTITUTE OF SCIENCE AND TECHNOLOGY, BANDLAGUDA is the record of bonafide work carried out by them under my guidance and supervision during the academic year 2014-2018.

Mr. MD SAJJAD
Assistant Professor
Project Guide

Mr. S. Murali M.E., Ph.D.
Head of the Department
MECHANICAL ENGINEERING

PRINCIPAL
MAHAVEER
INSTITUTE OF SCIENCE & TECHNOLOGY
Bandlaguda, Hyd-500 005.

External Examiner

MAHAVEER INSTITUTE OF SCIENCE & TECHNOLOGY

Vyasapuri, Bandlaguda, Keshavagiri Post, Hyderabad-500005.

DEPARTMENT OF MECHANICAL ENGINEERING



CERTIFICATE

This is to certify that the project work entitled "MAINTAINING STATE OF CHARGE (S.O.C) OF BATTERY USING REGENERATIVE BRAKING SYSTEM AN EDDY CURRENT BRAKING" is submitted by A.Pushpamjodi(14E31A0302), N.Akash(14E31A0347), G.Ravikamhi(14E31A0319), Shik Akib(14E31A0353), in partial fulfilment of the requirement for the award of the Degree of Bachelor of Technology in MECHANICAL ENGINEERING from MAHAVEER INSTITUTE OF SCIENCE AND TECHNOLOGY, during the academic year 2017-2018. The results embodied in this project report have not been submitted to any other University or Institute for the award of any degree.

Mr. B. Nageswar
Assistant Professor
Project Guide

Dr. S.MURALI
Professor and Head of the
Department

INTERNAL EXAMINER

PRINCIPAL
MAHAVEER
INSTITUTE OF SCIENCE & TECHNOLOGY
Bandlaguda, Hyd-500 005.

EXTERNAL EXAMINER

MAHAVEER INSTITUTE OF SCIENCE & TECHNOLOGY

Vyasapuri, Bandlaguda, Keshavnagar Post, Hyderabad-500005.

DEPARTMENT OF MECHANICAL ENGINEERING



CERTIFICATE

This is to certify that the project work entitled "DESIGN AND FABRICATION OF SHAFT DRIVEN BICYCLE" is submitted by
A. Arvind, B. Vasim, K. N. Lalitha Kalyan, in partial fulfilment of the requirement for the award of the Degree of Bachelor of Technology in MECHANICAL ENGINEERING from MAHAVEER INSTITUTE OF SCIENCE AND TECHNOLOGY, during the academic year 2014-2018. The results embodied in this project report have not been submitted to any other University or Institute for the award of any degree.

Mr. E. KRISHNA DEEPAK
Assistant Professor
Project Guide

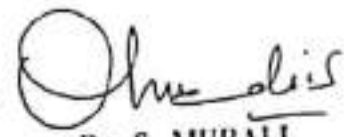
Dr. S. MURALI
Head of the Department

PRINCIPAL
MAHAVEER
INSTITUTE OF SCIENCE & TECHNOLOGY
Bandlaguda, Hyd-500 005.

EXTERNAL EXAMINER

MAHAVEER INSTITUTE OF SCIENCE & TECHNOLOGY

Vyasapuri, Bandlaguda, Keshavnigri Post, Hyderabad-500005.

DEPARTMENT OF MECHANICAL ENGINEERING



CERTIFICATE

This is to certify that the project work entitled "HEXACOPTER WHICH CAN LIFT A LOAD OF 2 KGS" is submitted by Mupparam Sadhana, Balasa Unnik, Unnikor Sakaran, Dusa Yashwanth in partial fulfilment of the requirement for the award of the Degree of Bachelor of Technology in MECHANICAL ENGINEERING from MAHAVEER INSTITUTE OF SCIENCE AND TECHNOLOGY, during the academic year 2017-2018.

The results embodied in this project report have not been submitted to any other University or Institute for the award of any degree.

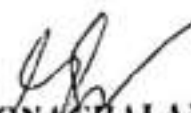
Mr. M. SONA CHALAM
Assistant Professor
Project Guide

Dr. S. MURALI
Head of the Department

PRINCIPAL
MAHAVEER
INSTITUTE OF SCIENCE & TECHNOLOGY
Bandlaguda, Hyd-500 005.

12/4/18
EXTERNAL EXAMINER

MAHAVEER INSTITUTE OF SCIENCE & TECHNOLOGY

Vyasapuri, Bandlaguda, Keshavagiri Post, Hyderabad - 500005.

DEPARTMENT OF MECHANICAL ENGINEERING



CERTIFICATE

This is to certify that the project work entitled "SOLAR POWERED STIRLING ENGINE" is submitted by Ujjwal Kishore G. Abhinav Reddy Mahaveer Institute of Science & Technology in partial fulfilment of the requirement for the award of the Degree of Bachelor of Technology in MECHANICAL ENGINEERING from MAHAVEER INSTITUTE OF SCIENCE AND TECHNOLOGY, during the academic year 2017-2018.

The results embodied in this project report have not been submitted to any other University or Institute for the award of any degree.

Dr. S. MURALI

Professor and Head

Project Guide

Dr. S. MURALI

Professor and Head

PRINCIPAL
MAHAVEER
INSTITUTE OF SCIENCE & TECHNOLOGY
BANDLAGUDA, HYD-500 005.

EXTERNAL EXAMINER

MAHAVEER INSTITUTE OF SCIENCE & TECHNOLOGY

Vyasapuri, Bandlaguda, Keshavagiri Post, Hyderabad-500005.

DEPARTMENT OF MECHANICAL ENGINEERING



CERTIFICATE

This is to certify that the project work entitled " FABRICATION OF SOLAR OPERATED PNEUMATIC RECIPROCATING WATER PUMPING SYSTEM" is submitted by K.Sushmitha, G.Vinay Kumar Reddy, MAkhilesh, E.Kalyan in partial fulfilment of the requirement for the award of the Degree of Bachelor of Technology in MECHANICAL ENGINEERING from MAHAVEER INSTITUTE OF SCIENCE AND TECHNOLOGY, during the academic year 2017-2018.

The results embodied in this project report have not been submitted to any other University or Institute for the award of any degree.

12/04/18
Mr. K.GANESAN
Assistant Professor
Project Guide

Dr. S.MURALI
Professor and Head of the
Department

PRINCIPAL
MAHAVEER
INSTITUTE OF SCIENCE & TECHNOLOGY
Bandlaguda, Hyd-500 005.

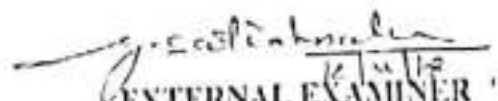
EXTERNAL EXAMINER

MAHAVEER INSTITUTE OF SCIENCE & TECHNOLOGY

Vyasapuri, Bandlaguda, Keshavagiri Post, Hyderabad-500005.

DEPARTMENT OF MECHANICAL ENGINEERING



CERTIFICATE

This is to certify that the project work entitled "FABRICATION OF ADVANCED WIND POWERED AUGMENTED ELECTRIC VEHICLE" is submitted by P RUKMANGADUDU, P KRISHNA, M VIJAY, D SHIVA KUMAR in partial fulfilment of the requirement for the award of the Degree of Bachelor of Technology in MECHANICAL ENGINEERING from MAHAVEER INSTITUTE OF SCIENCE AND TECHNOLOGY, during the academic year 2014-2018.

The results embodied in this project report have not been submitted to any other University or Institute for the award of any degree.

Mr. T. SHAHINSHA
Assistant Professor
Project Guide

Dr. S. MURALI M.E, Ph.D
Professor And Head

MAHAVEER
INSTITUTE OF SCIENCE & TECHNOLOGY
Bandlaguda, Hyd-500 005.

EXTERNAL EXAMINER

Vyasapuri, Bandlaguda, post: Keshavnagar
Hyderabad-500005, T.S. India
Tel: 040-24455001, 002,004,
Fax: 040-24455003
Email: Info@mist.ac.in
Web site: www.mist.ac.in

MAHAVEER
INSTITUTE OF SCIENCE & TECHNOLOGY
Approved by AICTE - Affiliated to JNTU,
Hyd.



DEPARTMENT OF MECHANICAL ENGINEERING



CERTIFICATE

This is to certify that the project entitled "EXPERIMENTAL INVESTIGATION ON CUSTOM 465 AND ALUMINUM H30 BY WIRE ELECTRIC DISCHARGE MACHINING (WEDM)" submitted by K VINOD KUMAR, MAKHIL, E RAGHU Y SAI KUMAR in partial fulfillment for the degree of bachelor of technology in DEPARTMENT OF MECHANICAL ENGINEERING to the MAHAVEER INSTITUTE OF SCIENCE AND TECHNOLOGY, BANDLAGUDA, HYDERABAD is the record of bonafide work carried out by them under guidance and supervision.

Mr. D. VENKATESH KUMAR
Assistant Professor
Project Guide

Dr. S. MURALI, M.E., Ph.D
Professor & Head
Mechanical Engineering

PRINCIPAL
MAHAVEER
INSTITUTE OF SCIENCE & TECHNOLOGY
BANDLAGUDA, HYDERABAD 500005

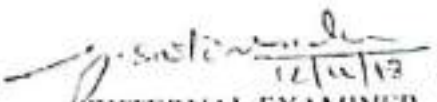
EXTERNAL EXAMINER

MAHAVEER INSTITUTE OF SCIENCE & TECHNOLOGY

Vyasapuri, Bandlaguda, Keshavagiri Post, Hyderabad-500005.

DEPARTMENT OF MECHANICAL ENGINEERING



CERTIFICATE

This is to certify that the project work entitled "DESIGN AND FABRICATION OF HYDRAULIC BAR/TUBE BENDING MACHINE" is submitted by A. Aravind Reddy, M. Nagesh, K. Aravind, Krishnaiah partial fulfilment of the requirement for the award of the Degree of Bachelor of Technology in MECHANICAL ENGINEERING from MAHAVEER INSTITUTE OF SCIENCE AND TECHNOLOGY, during the academic year 2017-2018.

The results embodied in this project report have not been submitted to any other University or Institute for the award of any degree.

Sathish
12/09/18
Mr. N. SATHISH KUMAR
Assistant Professor
Project Guide

S. Murali
Dr. S. MURALI
Head of the Department

Kishore
PRINCIPAL
MAHAVEER
INSTITUTE OF SCIENCE & TECHNOLOGY
Bandlaguda, Hyd-500 005.

W. S. S.
EXTERNAL EXAMINER

MAHAVEER INSTITUTE OF SCIENCE AND TECHNOLOGY

(Affiliated to JNTU Hyderabad, Approved by AICTE)

Vyasapuri, Bandlaguda, Post: Keshavnagar, Hyderabad-500005



ESTD: 2001

CERTIFICATE

This is to certify that Major Project entitled "FABRICATION OF FOOT STEP GENERATION BY RACK AND PINION MECHANISM" which is being submitted by MD SHOEBAKRAM (15E35A0305), HEEREKAR RAHUL (15E35A0303), ARROJU SHARAVAN (14E31A0363) AND SAI (14E31A0365) in partial fulfillment for the award of the degree of BACHELOR OF TECHNOLOGY in Mechanical Engineering of JAWAHARLAL NEHRU TECHNOLOGICAL UNIVERSITY is a record of the bonafide work out by them under guidance and supervision.

S.K. AMEER (PhD)

Sr Asst. Professor.

(GUIDE)

Dr. S. MURALI

Prof & Head

External Examiner

DR. K.S.S.N. REDDY

Principal
MAHAVEER

INSTITUTE OF SCIENCE & TECHNOLOGY
Bandlaguda, Hyderabad-500005

MAHAVEER INSTITUTE OF SCIENCE & TECHNOLOGY

Vyasapuri, Bandlaguda, Keshavnigri Post, Hyderabad-500005.

DEPARTMENT OF MECHANICAL ENGINEERING



CERTIFICATE

This is to certify that the project work entitled "FABRICATION OF THREE WAY MODERN PNEUMATIC TRAILER" is submitted by Mohd Suhail, Koppala Naresh Reddy, Rinju George, Shoaib Ahmed in partial fulfilment of the requirement for the award of the Degree of Bachelor of Technology in MECHANICAL ENGINEERING from MAHAVEER INSTITUTE OF SCIENCE AND TECHNOLOGY, during the academic year 2017-2018.

The results embodied in this project report have not been submitted to any other University or Institute for the award of any degree.

Mr. SUDHAKARA S.
Assistant Professor
Project Guide

Dr. S. MURALI
Head of the Department

PRINCIPAL
MAHAVEER
INSTITUTE OF SCIENCE & TECHNOLOGY
Bandlaguda, Hydr-500 005.

EXTERNAL EXAMINER

MAHAVEER INSTITUTE OF SCIENCE & TECHNOLOGY

Vyasapuri, Bandlaguda, Keshavnagar Post, Hyderabad-500005.

DEPARTMENT OF MECHANICAL ENGINEERING.



CERTIFICATE

This is to certify that the project work entitled "Semi Automatic Material Carrier For Mining And Tunneling Applications" is submitted by JADHIVA, HAKHLESII, C, VENKATESH, MSHIVAKUMAR in partial fulfilment of the requirement for the award of the Degree of Bachelor of Technology in MECHANICAL ENGINEERING from MAHAVEER INSTITUTE OF SCIENCE AND TECHNOLOGY, during the academic year 2017-2018.

The results embodied in this project report have not been submitted to any other University or Institute for the award of any degree.

P DURGA RAVI PRASAD

Assistant Professor

Project Guide

DR. S. MURALI

Head of Department

External Examiner

**PRINCIPAL
MAHAVEER
INSTITUTE OF SCIENCE & TECHNOLOGY
Bandlaguda, Hyd-500 005.**

MAHAVEER INSTITUTE OF SCIENCE AND TECHNOLOGY

Vyasapuri, Bandlaguda, Keshavnagiri Post, Hyderabad-500005.

DEPARTMENT OF MECHANICAL ENGINEERING



CERTIFICATE

This is to certify that the project work entitled "DESIGN AND FABRICATION OF PNEUMATIC PEDAL BRAKING SYSTEM BY USING HAND CONTROLLED VALVES" is submitted by N.Surendra, G.Raghuvardhan Reddy, Syed Md.Ahmed Mohiuddin Quadri and M.A.Raheman in partial fulfilment of the requirement for the award of the Degree of Bachelor of Technology in MECHANICAL ENGINEERING from MAHAVEER INSTITUTE OF SCIENCE AND TECHNOLOGY, during the academic year 2017-2018.

The results embodied in this project report have not been submitted to any other University or Institute for the award of any degree.

G.K. Shanmuk Dev
Mr.G.K.SHANMUK DEV
Associate Professor
Project Guide

Dr. S. Murali
Dr. S. MURALI
Professor and Head of the Department



W. G. Sharma
EXTERNAL EXAMINER

MAHAVEER INSTITUTE OF SCIENCE & TECHNOLOGY

Vyasapuri, Bandlaguda, Keshavnagar Post, Hyderabad-500005.

DEPARTMENT OF MECHANICAL ENGINEERING



CERTIFICATE

This is to certify that the project work entitled "FABRICATION OF FOUR ACTING POWER HACKSAW MACHINE USING SCOTCH YOKE MECHANISM" is submitted by Mohd Farooq, Mohd Abdul Rahman, Pitha Swamy, Syed Ashfaq in partial fulfillment of the requirement for the award of the Degree of Bachelor of Technology in MECHANICAL ENGINEERING from MAHAVEER INSTITUTE OF SCIENCE AND TECHNOLOGY, during the academic year 2017-2018.

The results embodied in this project report have not been submitted to any other University or Institute for the award of any degree.

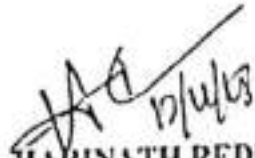
Mr. B. HARINATH REDDY
Assistant Professor
Project Guide

Dr. S. MURALI
Head of the Department

M. MAHAVEER
PRINCIPAL
MAHAVEER
INSTITUTE OF SCIENCE & TECHNOLOGY
Bandlaguda, Hyd-500 005.

EXTERNAL EXAMINER

MAHAVEER INSTITUTE OF SCIENCE & TECHNOLOGY

Vyasapuri, Bandlaguda, Keshavagiri Post, Hyderabad-500005.

DEPARTMENT OF MECHANICAL ENGINEERING.



CERTIFICATE

This is to certify that the project work entitled "ELECTRO PERMANENT MAGNET BASED ANTENNA EJECTION MECHANISM" is submitted by Poojey, G. Narendra, Mohammed Akbar, Mohammed Farhan Uddin in partial fulfilment of the requirement for the award of the Degree of Bachelor of Technology in MECHANICAL ENGINEERING from MAHAVEER INSTITUTE OF SCIENCE AND TECHNOLOGY, during the academic year 2017-2018.

The results embodied in this project report have not been submitted to any other University or Institute for the award of any degree.

Mr. P. HARI
Assistant Professor
Project Guide

Dr. S. MURALI
Head of the Department

MAHAVEER
INSTITUTE OF SCIENCE & TECHNOLOGY
Bandlaguda, Hyd-500 005.

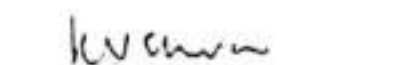
EXTERNAL EXAMINER

MAHAVEER INSTITUTE OF SCIENCE & TECHNOLOGY
Vyasapuri, Bandlaguda, Keshavagiri Post, Hyderabad-500005

DEPARTMENT OF MECHANICAL ENGINEERING



CERTIFICATE

This is to certify that the Project work entitled "SOLAR ENERGY TO THERMAL REFRIGERATION USING PELTIER EFFECT" that is being submitted by Mohd Muqtar Ahmed Khan, N Vinesh Reddy, Fazal Ahmed Kamil, Mohammed Omer in partial fulfilment of the requirement for the award of the Degree of Bachelor of Technology in MECHANICAL ENGINEERING from MAHAVEER INSTITUTE OF SCIENCE AND TECHNOLOGY, during the academic year 2017-2018.

The results embodied in this project report have not been submitted to any other University or Institute for the award of any degree.

Mr. M RAMDAS
Associate Professor
Project Guide

Dr. S MURALI, M.E, PhD
Professor and Head of the Department

PRINCIPAL
MAHAVEER
INSTITUTE OF SCIENCE & TECHNOLOGY
Bandlaguda, Hyd-500 005

EXTERNAL EXAMINER

ECE MAJOR PROJECT(A.Y 2017-18)

S.No	Roll No	Name of Student	Major Project title
1	14E31A0441	P AKHIL REDDY	Approximate error detection using stochastic checker
2	14E31A0401	A ABHILASH REDDY	
3	14E31A0427	KOLLURU VINAY RAJA	
4	14E31A0443	PABBU SHIVAKUMAR	
5	14E31A0447	PATHI SAI BHAVAN	
6	14E31A0449	VELDANDI LAXMI PRASAN	Vedic multiplier
7	14E31A0422	KAMSANI NAVEENKUMAR	
8	14E31A0411	CINTHOJI VINAY KUMAR C	
9	14E31A0460	YESHALA HARISH	Iot based smart robot using wi-fi module
10	14E31A0428	KONDAM MONIKA REDDY	
11	14E31A0431	LANKALA BHARGAVI	
12	14E31A0416	GAJULA VINAY	
13	14E31A0446	PARVATHALA NAVYA	
14	14E31A0440	NANDYALA SRAVANTHI	Comparative study of 16 order fir filter design using different multiplier techniques.
15	14E31A0439	NAMPALLY AVANTHI	
16	14E31A0420	ILY SAINATH	
17	14E31A0458	VEDAM RAJESH	
18	14E31A0430	KOTHA ALEKHYA	High speed and power vlsi architecture for inexact speculative adder.
19	14E31A0410	CHITTEDI PRATHIBHA	
20	14E31A0403	AELGANI ARCHANA GOUD	
21	14E31A0406	AVVARI SHIVA PRASAD	Iot based energy aware smart home control system
22	14E31A0448	PEDDIRAJU VENKATA	
23	14E31A0408	B SAI KIRAN YADAV	
24	14E31A0452	RIJIN STALIN	
25	14E31A0435	MOHAMMAD AJITH	Design of asynchronous counter using novel
26	14E31A0412	DEGALA VEENA	
27	14E31A0432	M MAHESH KUMAR	
28	14E31A0402	A CHINNAREDDY	
29	14E31A0445	PANASA UDAY	

 PRINCIPAL
 RAJESH K. VEER
 Principal, JNTU & HODS, 061
 Hyderabad-500 005

30	14E31A0426	KEESARA BHARATHI	Design of asynchronous counter using novel reversible s/r gate.
31	14E31A0404	AKULA AKHIL	
32	14E31A0421	JUJURU SAINADHI	
33	14E31A0454	SAREDDY JOSHNA	Wi-fi based agriculture environment monitoring system using android mobile application
34	14E31A0405	ARRA RAJ KUMAR	
35	14E31A0407	B AKHIL KUMAR	
36	14E31A0413	DHARMA SHAILAJA	Development of patient monitoring system using smart phone
37	14E31A0423	ANUKUNTA SAI HARINI	
38	14E31A0483	M.RAJA REDDY	
39	14E31A0498	T.VENKATESH	Fault tolerant parallel ffts using error correction codes and partial checks
40	15E35A0408	S.BHARATH KUMAR	
41	14E31A0475	K.ANUP KUMAR	
42	14E31A0485	N.PAVANI	Ethernet controller for home appliances using internet
43	14E31A0474	K.UDAYCHANDRIKA	
44	15E35A0409	S.MANO HAR	
45	15E35A0402	G.KEERTHI	
46	15E35A0411	K.VISHNU	
47	14E31A0486	P.BHARGAVI	Advanced parking system
48	14E31A0499	V.PALLAVI	
49	14E31A0461	A.BHARGAVI	
50	14E31A0470	G.SURESH KUMAR	Design and implementation of aes algorithm
51	14E31A0476	K.SAMPATH	
52	14E31A0478	M.SAI TEJA	
53	15E35A0405	M.SREEVANI	
54	15E35A0401	B.SAI VARMA	Wireless realtime home appliances control system using zigbee and bluetooth
55	14E31A0467	D.MONICA	
56	14E31A0473	J.SAI CHANDRA	
57	14E31A0466	CHLPOOJA	
58	14E31A0489	P.BHARATH KUMAR	
59	13E31A0467	B.ROHIT	I use human detecting robot for earthquake rescue operation using
60	14E31A0497	T.SRIDITHYA	
61	14E31A0477	MAKSHITHA	

Kavya
 PRINCIPAL
 M. S. S. VEER
 DEPARTMENT OF SCIENCE & TECHNOLOGY
 Bangalore, Hyd-500 005.

62	15E35A0407	M.POOJA RANI	LIVE DEMO DURING 1000th CELEBRATION TCS&C OPERATION USING gsm and gps
63	14E31A0488	P.PRUDVEE	
64	15E35A0403	G.SAITTEJA	
65	14E31A0462	A.SREEJA	Design and implementation of tpg using Ip-Ilsr
66	14E31A0493	S.GJITHENDER	
67	14E31A0472	G.SHIVA KUMAR	
68	14E31A0491	R.PRANEETH	Bluetooth gps application based latitude and longitude for child tracking model
69	14E31A0471	G.RAVALIKA	
70	14E31A0479	M.LIKITH KUMAR	
71	15E35A0406	M.JAIPAL	Sms based weather reporting
72	15E35A0404	M.SHIVARAM	
73	13E31A0408	B.VISHNU TEJA	
74	13E31A0422	K.VAMSHI KRISHNA	Air pollution monitoring at special zones like schools and hospitals
75	13E31A04A7	L.THIRUPATHI RAJ	
76	13E31A04B3	E.HARI KRISHNA	
77	13E31A0450	S.SANTHOSH	
78	13E31A04C7	R.RAKESH	
79	14E35A0403	M.VAMSHI KRISHNA	
80	12E35A0406	G.YASHWANTHI	

Co-ordinator

HOD, ECE Dept

PRINCIPAL
MAHAVEER
INSTITUTE OF SCIENCE & TECHNOLOGY
Gandhinagar, Hyd-500 005.

Vysapuri, Bandlaguda Post: Keshavagiri,
Hyderabad-500005, TS, INDIA
Tel: 040-20020772, 20020773, Fax: 040-24455003
E-mail: c.hod.ece@gmail.com
Website: www.mist.ac.in

MAHAVEER



Approved by AICTE, Affiliated to JNTU, Hyd

CERTIFICATE

This is to certify that the project work entitled "Image Processing by using Xilinx System Generator" is submitted by

P.Uday
K.Bharath
A.Akhil
J.Sainath

Roll No.14E31A0445
Roll No.14E31A0426
Roll No.14E31A0404
Roll No.14E31A0421

P. G. H.
J. Sainath

In partial fulfillment of the requirements for the Degree of Bachelor of Technology in Electronics and Communication Engineering of Mahaveer Institute of Science and Technology, Hyderabad, during the academic year 2017-18, is a bonafide record of work carried out under our guidance and supervision. The results embodied in this report have not been submitted to any other university or Institution for the award of any degree or diploma.

Mr. R. Prabhakar
Asst. Professor
Project Guide

Dr. Jaspal Kumar
Professor
Project Coordinator

Dr. P. Guanasivan
Professor
Head of the Dept.



External Examiner

PRINCIPAL
MAHAVEER
INSTITUTE OF SCIENCE & TECHNOLOGY
Bandlaguda, Hyd-500 005.



Certificate

This is to certify that

P.UDAY	14E31A045
K. BHARATH	14E31A0426
A. AKHIL	14E31A0404
J. SAINATH	14E31A0421

Students of final year B.Tech. Electronics and Communication Engineering, MAHAVEER INSTITUTE OF SCIENCE AND TECHNOLOGY, HYDERABAD (*affiliated to J.N.T.University, Hyderabad*), have successfully completed their project titled "IMAGE PROCESSING USING XILINX SYSTEM GENERATOR" in VLSI DIVISION, CONSCIENCE TECHNOLOGIES (CT), Hyderabad.

For CONSCIENCE TECHNOLOGIES

Project Manager

B.V. Krishna Reddy
B.V.KRISHNA REDDY

Sulig
PRINCIPAL
MAHAVEER
INSTITUTE OF SCIENCE & TECHNOLOGY
Sandbaguda, Hyd-500 005.

Vysapuri, Bandlaguda,
Post: Keshavpuri,
Hyderabad-500 005, TS,
INDIA Tel: 040-20020772,
20020773, Fax: 040-
24455003
E-mail:
e3hod_ece@gmail.com
Website: www.mist.ac.in

MAHAVEER

INSTITUTE OF SCIENCE & TECHNOLOGY

Approved by AICTE, Affiliated to JNTUH, Hyd.



CERTIFICATE

This is to certify that the project work entitled "Temperature monitoring & indicator with RTC" is submitted by

Farha Gazal
G.Amrutha
G.Sneha
Samreen Begum

Roll No. : 14E31A0414
Roll No. : 14E31A0415
Roll No. : 14E31A0417
Roll No. : 14E31A0453

Sneha
G. Amrutha
G. Sneha
Samreen

In partial fulfillment of the requirements for the Degree of Bachelor of Technology in Electronics & Communication Engineering of Mahaveer Institute of Science & Technology, Hyderabad, during the academic year 2017-18, is a bonafide record of work carried out under our guidance and supervision.

The results embodied in this report have not been submitted to any other university or Institution for the award of any degree or diploma.

Dr. Jaspal Kumar
Professor
Guide & Co-Ordinator

Dr. P. Gnanasivam
Professor
Head of Dept.



External Examiner

Kishor
MAHAVEER INSTITUTE OF SCIENCE & TECHNOLOGY
HYDERABAD
2017-18

क्र.सं. S.No. 92750



भारत डायनामिक्स लिमिटेड
BHARAT DYNAMICS LIMITED
(भारत सरकार का उद्यम A Govt. of India Enterprise)
रक्षा मंत्रालय Ministry of Defence
कंचनबाग Kanchanbagh :: हैदराबाद Hyderabad - 500058.

प्रणाली प्रौद्योगिकी तथा प्रबंधन संस्थान
INSTITUTE OF SYSTEMS, TECHNOLOGY AND MANAGEMENT



वर्ष Year 2018

पंजीकरण संख्या Regd. No. 370

Skill India
शिक्षण - पूरक कला

परियोजना प्रमाण-पत्र PROJECT CERTIFICATE

सुश्री/श्री

Ms./Mr.

SABHA MAZAL

पुत्री/पुत्र श्रीमती एवं श्री

Daughter/Son of Smt. SABIYA SULTHANA Shri MOHAMMED ABDUL RADEER

कॉलेज/संस्थान

College/Institute

MAHAVEER INSTITUTE OF SCIENCE & TECH

विषय / क्षेत्र

Subject/Discipline

B.TECH (ECE)

वर्ष/सेमिस्टर

Year/Semester

परियोजना कार्य/प्रशिक्षण कार्य

has completed Project Work / Training on TEMPERATURE MONITORING

& INDICATOR WITH RTC

Duration TWO MONTHS Period from 12-01-2018 to 11-03-2018

के बीच पूर्ण किया है.

इस कार्य के दौरान इन्होंने अध्ययन में पर्याप्त रुचि दिखाई है.

He/She has shown keen interest in learning during the period of Project.

प्रमुख (मा.सं.वि.)
Head (HRD)

सय्यद रफी
SYED RAFFE

मुहर
Seal

प्रभारी, परियोजना कार्य
Incharge, Project Works

श्री: प्रवीण कुमार

P. PRAVEEN KUMAR

प्रमुख (मा.सं.वि.)
Manager (P&A) - KBU

नगरप्रबंधक (का. एवं प्रशा.) - के.पी.यू.
General Manager (P&A) - KBU

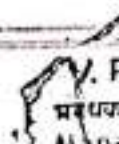

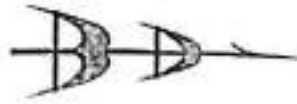

भारत डायनामिक्स लिमिटेड
BHARAT DYNAMICS LIMITED
(भारत सरकार का उद्यम A Govt. of India Enterprise)

रक्षा मंत्रालय Ministry of Defence
कंचनबाग Kanchanbagh :: हैदराबाद Hyderabad - 500058.

प्रणाली प्रौद्योगिकी तथा प्रबंधन संस्थान
INSTITUTE OF SYSTEMS, TECHNOLOGY AND MANAGEMENT

वर्ष Year 2018



Skill India
शिक्षण - कौशल - रोजगार

पंजीकरण संख्या Regd. No. 371

परियोजना प्रमाण-पत्र PROJECT CERTIFICATE

सुश्री/श्री
Ms./Mr. G. Amrutha

पुत्री/पुत्र श्रीमती एवं श्री
Daughter/Son of Smt. G. Gayatri Shri G. Pandurang

कॉलेज/संस्थान
College/Institute Mahaveer Institute of Science & Tech. में

विषय/क्षेत्र
Subject/Discipline B-Tech (ECE) वर्ष/सेमिस्टर
Year/Semester _____ में

परियोजना कार्य/प्रशिक्षण कार्य
has completed Project Work / Training on Temperature Monitoring
And Indicator with RTC

Duration 2 Months Period from 12/01/18 to 11/03/2018 में
के बीच पूर्ण किया है. K. Sankar

इस कार्य के दौरान इन्होंने अध्ययन में पर्याप्त रुचि दिखाई है.

He/She has shown keen interest in learning during the period of Project.

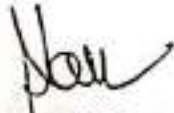
प्रमुख (मा.सं.वि.)
Head (HRD)
सय्यद रफी
SYED RAFFE

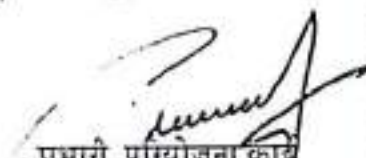

प्रभारी, परियोजना कार्य
Incharge, Project Works

क्र.सं. S.No. 92748

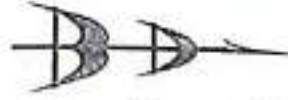

भारत डायनामिक्स लिमिटेड

BHARAT DYNAMICS LIMITED

(भारत सरकार का उद्यम A Govt. of India Enterprise)

रक्षा मंत्रालय Ministry of Defence

कंचनबाग Kanchanbagh :: हैदराबाद Hyderabad – 500058.

प्रणाली प्रौद्योगिकी तथा प्रबंधन संस्थान

INSTITUTE OF SYSTEMS, TECHNOLOGY AND MANAGEMENT



Skill India
शिक्षण भारत - कृषि कर्म

वर्ष Year 2018

पंजीकरण संख्या Regd. No. 369

परियोजना प्रमाण-पत्र PROJECT CERTIFICATE

सुश्री/श्री

Ms./Mr. श्री. SNEHA

पुत्री/पुत्र श्रीमती एवं श्री

Daughter/Son of Smt. श्री. BHAGYAMMA श्री श्री. RAJI REDDY

कॉलेज/संस्थान

College/Institute MAHAVEER INSTITUTE OF SCIENCE & TECH

विषय / क्षेत्र

Subject/Discipline B. TECH (ECE)

वर्ष/सेमिस्टर

Year/Semester

परियोजना कार्य/प्रशिक्षण कार्य

has completed Project Work / Training on TEMPERATURE MONITORING AND INDICATOR WITH RTC

Duration TWO MONTHS Period from 12/01/2018 to 11/03/2018

के बीच पूर्ण किया है.

इस कार्य के दौरान इन्होंने अध्ययन में पर्याप्त रुचि दिखाई है.

He/She has shown keen interest in learning during the period of Project.

प्रमुख (मा.सं.वि.)

Head (HRD)

सय्यद रफी

-SYED RAFFE

संयोजक (प्र. एवं प्रशा.) - के.वी.यू.

General Manager (P&A)- KBU



PRINCIPAL
MAHAVEER

INSTITUTE OF SCIENCE & TECHNOLOGY
Kanchanbagh, Hyd-500 005.

प्रभारी, परियोजना कार्य

Incharge Project Works

V. PRAVEEN KUMAR

प्रबंधक (प्र. एवं प्रशा.) - के.वी.यू.

Manager (P&A)- KBU

क्र.सं. S.No. 02749

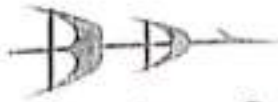

भारत डायनामिक्स लिमिटेड
BHARAT DYNAMICS LIMITED
(भारत सरकार का उद्यम A Govt. of India Enterprise)

रक्षा मंत्रालय Ministry of Defence
कंचनबाग Kanchanbagh :: हैदराबाद Hyderabad - 500058.

प्रणाली प्रौद्योगिकी तथा प्रबंधन संस्थान
INSTITUTE OF SYSTEMS, TECHNOLOGY AND MANAGEMENT

वर्ष Year 2018



Skill India
शिक्षण का नया आयाम

पंजीकरण संख्या Regd. No. 368

परियोजना प्रमाण-पत्र PROJECT CERTIFICATE

सुश्री/श्री
Ms./Mr. Samreen Begum

पुत्री/पुत्र श्रीमती एवं श्री
Daughter/Son of Smt. Sameena Begum Shri Qudrath Pasha. MD

कॉलेज/संस्थान
College/Institute Mahaveer Institute of Science & Tech.

विषय/क्षेत्र
Subject/Discipline B-Tech (ECE) वर्ष/सेमिस्टर
Year/Semester मे

परियोजना कार्य/प्रशिक्षण कार्य
has completed Project Work / Training on Temperature Monitoring
and Indicators with RTC

Duration 2 Months Period from 12/01/2018 to 11/03/2018

के बीच पूर्ण किया है.

Kishu

इस कार्य के दौरान इन्होंने अध्ययन में पर्याप्त रुचि दिखाई है.

He/She has shown keen interest in learning during the period of Project.

Raffa
प्रमुख (मा.सं.वि.)
Head (HRD)
सय्याद रफी
SYED RAFFE



Kishu
प्रभारी, परियोजना कार्य
Incharge, Project Works
श्री. प्रदीप कुमार

संयोजक (आ. एवं प्रशा.) - के.डी.सू.
Joint Manager (P&A) - KDU

Vysapuri, Bandlaguda Post: Keshavagiri,
Hyderabad-500005, TS, INDIA
Tel: 040-20020772, 20020773, Fax: 040-24455003
E-mail: e3hod.ece@gmail.com
Website: www.mist.ac.in

MAHAVEER

INSTITUTE OF SCIENCE & TECHNOLOGY

Approved by AICTE Affiliated to JNTU, Hyd



CERTIFICATE

This is to certify that the project work entitled "GSM based data acquisition system for missiles" is submitted by

MD.Azhar Hussain

Roll No. 14E31A0436

MD.Suleman Ahmed

Roll No. 14E31A0437

K.Manish Reddy

Roll No. 14E31A0434

G.B.S.Harsha

Roll No. 14E31A0418

In partial fulfillment of the requirements for the Degree of Bachelor of Technology in Electronics and Communication Engineering of Mahaveer Institute of Science and Technology, Hyderabad, during the academic year 2017-18, is a bonafide record of work carried out under our guidance and supervision. The results embodied in this report have not been submitted to any other university or Institution for the award of any degree or diploma.

P.Sridhar
Assoc.Professor
Project Guide

Dr Jaspal
Professor
Project Coordinator

Dr P. Gnanasivam
Professor &
Head of the Dept



MAHAVEER
INSTITUTE OF SCIENCE & TECHNOLOGY
Hyderabad, Hyd-500 005.

क्र.सं. S.No. 92741

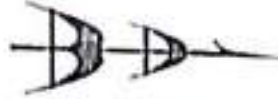

भारत डायनामिक्स लिमिटेड

BHARAT DYNAMICS LIMITED

(भारत सरकार का उद्यम A Govt. of India Enterprise)

रक्षा मंत्रालय Ministry of Defence

कंचनबाग Kanchanbagh :: हैदराबाद Hyderabad – 500058.

प्रणाली प्रौद्योगिकी तथा प्रबंधन संस्थान

INSTITUTE OF SYSTEMS, TECHNOLOGY AND MANAGEMENT

वर्ष Year 2018



पंजीकरण संख्या Regd. No. 366

Skill India

परियोजना प्रमाण-पत्र PROJECT CERTIFICATE

सूत्री/श्री

Ms./Mr. Mohammed Azhar Hussain

पुत्री/पुत्र शीघती एवं श्री

Daughter/Son of Smt. Salma Begum Shri Mohammed Hussain

कॉलेज/संस्थान

College/Institute Mahaveer Institute of Science & Technology

विषय / क्षेत्र

Subject/Discipline B-Tech (ECE) वर्ष/सेमेस्टर IVth / IIrd

परियोजना कार्य / प्रशिक्षण कार्य

has completed Project Work / Training on GISM Based Data Acquisition System for Missile

Duration 45 days Period from 11/01/2018 to 26/02/2018

के बीच पूर्ण किया है.

इस कार्य के दौरान इन्होंने अध्ययन में पर्याप्त रुचि दिखाई है.

He/She has shown keen interest in learning during the period of Project.

Nayk

प्रमुख (मा.सं.वि.)
Head (HRD)
सय्यद रफी
SYED RAFFE



V. Praveetha Kumar
प्रभारी, परियोजना कार्य

Incharge, Project Works
श्री. प्रवीण कुमार
V-PRAVEETHAKUMAR

रर महानिर्देशक (का. एवं प्रशा.) - के.वी.यू.
ddl. General Manager (P&A)-KBU

उप प्रबंधक (का. एवं प्रशा.) शिशु एवं प्रशि.
Dy. Manager (P&A) Appr. & Trgs.

क्र.सं. S.No. 92742

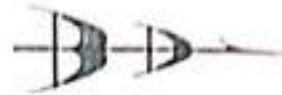

भारत डायनामिक्स लिमिटेड

BHARAT DYNAMICS LIMITED

(भारत सरकार का उद्यम A Govt. of India Enterprise)

रक्षा मंत्रालय Ministry of Defence

कंचनबाग Kanchanbagh :: हैदराबाद Hyderabad - 500058.

प्रणाली प्रौद्योगिकी तथा प्रबंधन संस्थान

INSTITUTE OF SYSTEMS, TECHNOLOGY AND MANAGEMENT

वर्ष Year 2018



पंजीकरण संख्या Regd. No. 365

Skill India

परियोजना प्रमाण-पत्र PROJECT CERTIFICATE

सूत्री/श्री

Ms./Mr. Mohd Suleman : Ahmed

पुत्री/पुत्र श्रीमती एवं श्री

Daughter/Son of Smt. Asma Shri Mohd Afsar Ahmed

कॉलेज/संस्थान

College/Institute Mahaveer Institute of Science & Technology

विषय / क्षेत्र

Subject/Discipline B-Tech (ECE) वर्ष/सेमेस्टर IVth / IInd

परियोजना कार्य/प्रशिक्षण कार्य

has completed Project Work / Training on GSM Based Data Acquisition System for Missile

Duration 45 days Period from 11/01/2018 to 26/02/2018

के बीच पूर्ण किया है.

इस कार्य के दौरान इन्होंने अध्ययन में पर्याप्त रुचि दिखाई है.

He/She has shown keen interest in learning during the period of Project.

Naseer

प्रमुख (मा.सं.वि.)

Head (HRD)

सय्यद रफी

SYED RAFFI



[Signature]

प्रभारी, परियोजना कार्य

Incharge, Project Works

वी. प्रदीप कुमार

V. PRADEEP KUMAR

PRINCIPAL
MAHAVEER
INSTITUTE OF SCIENCE & TECHNOLOGY
Kanchanbagh, Hyd-500058.

अपर महाप्रबंधक (आ. एवं प्रशा.) - के.बी.यू.
Addl. General Manager (P&A)- KBU

उप प्रबंधक (आ. एवं प्रशा.) शिवाय एवं प्रशि.
Dy. Manager (P&A) Appr. & Treg.

क्र.सं. S.No. 92733



भारत डायनामिक्स लिमिटेड
BHARAT DYNAMICS LIMITED
(भारत सरकार का उद्यम A Govt. of India Enterprise)

रक्षा मंत्रालय Ministry of Defence
कंचनबाग Kanchanbagh :: हैदराबाद Hyderabad - 500058.

प्रणाली प्रौद्योगिकी तथा प्रबंधन संस्थान
INSTITUTE OF SYSTEMS, TECHNOLOGY AND MANAGEMENT

वर्ष Year 2018



Skill India

पंजीकरण संख्या Regd. No. 364

परियोजना प्रमाण-पत्र PROJECT CERTIFICATE

सुश्री/श्री

Ms./Mr.

K. Manish Reddy

पुत्री/पुत्र श्रीमती एवं श्री

Daughter/Son of Smt.

K. Indira

श्री K. Chandra Reddy

कॉलेज/संस्थान

College/Institute

Mahaveer Institute of Science & Technology

विषय / क्षेत्र

Subject / Discipline

B-Tech (ECE)

वर्ष/सेमिस्टर

Year / Semester

IVth / IInd

परियोजना कार्य / प्रशिक्षण कार्य

has completed Project Work / Training on

GSM Based Data

Acquisition System for Missile

Duration

45 days

Period from

11/01/2018

से

to 26/02/2018

के बीच पूर्ण किया है.

इस कार्य के दौरान इन्होंने अध्ययन में पर्याप्त रुचि दिखाई है.

He/She has shown keen interest in learning during the period of Project.

प्रमुख (मा.सं.वि.)
Head (HRD)

सय्यद रफी

SYED RAHAF



V. Praveen Kumar
प्रभारी, परियोजना कार्य

Incharge, Project Works

वी. प्रवीण कुमार

V. PRAVEEN KUMAR

सहायक (का. एवं प्रशा.) - के.वी.यू.
General Manager (P&A)-KBU

उप प्रबंधक (का. एवं प्रशा.) शिबु एवं प्रशि.
Dy. Manager (P&A) Appr. & Trgs.

क्र.सं. S.No. 92740

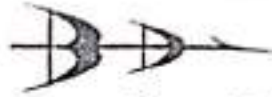

भारत डायनामिक्स लिमिटेड

BHARAT DYNAMICS LIMITED

(भारत सरकार का उद्यम A Govt. of India Enterprise)

रक्षा मंत्रालय Ministry of Defence

कंचनबाग Kanchanbagh :: हैदराबाद Hyderabad - 500058.

प्रणाली प्रौद्योगिकी तथा प्रबंधन संस्थान

INSTITUTE OF SYSTEMS, TECHNOLOGY AND MANAGEMENT

वर्ष Year 2018



पंजीकरण संख्या Regd. No. 367

Skill India

परियोजना प्रमाण-पत्र PROJECT CERTIFICATE

सुश्री/श्री

Ms./Mr.

G. Bharath Subramanaya Harsha

पुत्री/पुत्र श्रीमती एवं श्री

Daughter/Son of Smt.

G. Annapurna

Shri

G. Prasada Rao

कॉलेज/संस्थान

College/Institute

Mahaveer Inst. of Science & Tech.

विषय/क्षेत्र

Subject/Discipline

B-Tech (ECE)

वर्ष/सेमिस्टर

Year/Semester

IVth/IIInd

परियोजना कार्य/प्रशिक्षण कार्य

has completed Project Work/Training on GSM Based Data Acquisition

System for Missile

Duration

45 days

Period from

11/01/2018

से

to 26/02/2018

के बीच पूर्ण किया है.

इस कार्य के दौरान इन्होंने अध्ययन में पर्याप्त रुचि दिखाई है.

He/She has shown keen interest in learning during the period of Project.

प्रमुख (मा.सं.वि.)
Head (HRD)

सख्यद राफी

SYED RAFFE



प्रभारी, परियोजना कार्य

Incharge, Project Works

श्री. रवींद्र कुमार

र महाप्रबंधक (का. एवं प्रशा.) - के.बी.यू.
Mr. General Manager (P&A)-KBU

प्रमुख (मा.सं.वि.)
Mr. Manager (P&A) - KBU

Vysapuri, Bandlaguda Post: Keshavagiri,
Hyderabad-500005, TS, INDIA
Tel: 040-20020772, 20020773, Fax: 040-24455003
E-mail: e3hod.cce@gmail.com
Website: www.mist.ac.in

MAHAVEER

Approved by AICTE, Affiliated to JNTU, Hyd



CERTIFICATE

This is to certify that the project work entitled "Design of an Asynchronous Counter Using Novel Reversible SG Gate" is submitted by

Md.Ajith Pasha

D.Veena

M.Mahesh Kumar

A.Chinna Reddy

Roll No. 14E31A0435

Roll No. 14E31A0412

Roll No. 14E31A0432

Roll No. 14E31A0402

In partial fulfillment of the requirements for the Degree of Bachelor of Technology in Electronics & Communication Engineering of Mahaveer Institute of Science & Technology, Hyderabad, during the academic year 2017-18, is a bonafide record of work carried out under our guidance and supervision. The results embodied in this report have not been submitted to any other University or Institution for the award of any degree or diploma.

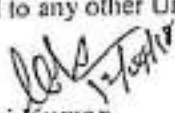

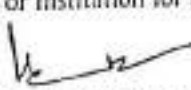
Mr. N. Ravi Kumar
Asst. Professor
Project Guide

Dr. Jaspal Kumar
Professor
Project Coordinator

Dr. P. Gnanasivam
Professor
Head of the Dept.



External Examiner

PRINCIPAL
MAHAVEER
INSTITUTE OF SCIENCE & TECHNOLOGY
Bandlaguda, Hyd-500 005.



Certificate

This is to certify that

MD. AJITH PASHA

14E31A0435

D. VEENA

14E31A0412

M. MAHESH KUMAR

14E31A0432

A. CHINNA REDDY

14E31A0402

Students of final year B.Tech, Electronics and Communication Engineering, MAHAVEER INSTITUTE OF SCIENCE AND TECHNOLOGY, HYDERABAD (affiliated to J.N.T.University, Hyderabad), have successfully completed their project titled "DESIGN OF AN ASYNCHRONOUS COUNTER USING NOVEL REVERSIBLE SG GATE" in VLSI DIVISION, CONSCIENCE TECHNOLOGIES (CT), Hyderabad.

For CONSCIENCE TECHNOLOGIES

Project Manager

B.V.KRISHNA REDDY

Krishna
PRINCIPAL
MAHAVEER
INSTITUTE OF SCIENCE & TECHNOLOGY
Bundlagauda, Hyd-500 005.

Vysapuri, Bandlaguda Post: Keshavagiri,
Hyderabad-500005, TS, INDIA
Tel: 040-20020772, 20020773, Fax: 040-24455003
E-mail: eMod.ece@gmail.com
Website: www.mist.ac.in

MAHAVEER

INSTITUTE OF SCIENCE & TECHNOLOGY
Approved by AICTE, Affiliated to JNTU(Hydr.)



CERTIFICATE

This is to certify that the project work entitled "Wi-Fi Based Agriculture Environment Monitoring System Using Android Mobile Application" is submitted by

S.Joshna
B.Akhil Kumar
A.Raj Kumar

Roll No. :14E31A0454
Roll No. :14E31A0407
Roll No. :14E31A0405

Graddy
Pradyumn
Boys

In partial fulfillment of the requirements for the Degree of Bachelor of Technology in Electronics & Communication Engineering of Mahaveer Institute of Science & Technology, Hyderabad, during the academic year 2017-18, is a bonafide record of work carried out under our guidance and supervision. The results embodied in this report have not been submitted to any other University or Institution for the award of any degree or diploma.

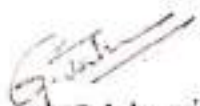
Mrs. G. Jahnvi
Asst Professor
Project Guide

Dr. Jaspal Kumar
Professor
Project Coordinator

Dr. P. Gnanasivam
Professor
Head of the Dept.

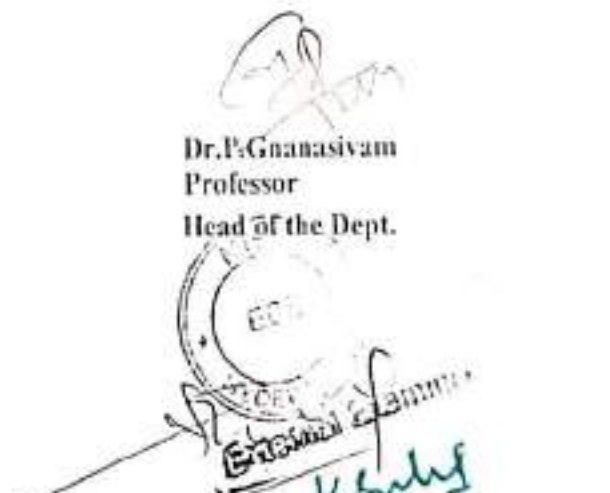
Principal
MAHAVEER
INSTITUTE OF SCIENCE & TECHNOLOGY
Bandlaguda, Hyd-500 005.



Certificate

This is to certify that

B. AKHIL KUMAR

14E31A0407

S. JOSHNA

14E31A0454

A. RAJ KUMAR

14E31A0405

Students of final year B.Tech, Electronics and Communication Engineering, MAHAVEER INSTITUTE OF SCIENCE AND TECHNOLOGY, HYDERABAD (affiliated to J.N.T. University, Hyderabad), have successfully completed their project titled "WI-FI BASED AGRICULTURE ENVIRONMENT MONITORING SYSTEM USING ANDROID MOBILE APPLICATION" in EMBEDDED SYSTEMS, CONSCIENCE TECHNOLOGIES (CT), Hyderabad.

From CONSCIENCE TECHNOLOGIES

Project Manager

B.V. Reddy
B.V. KRISHNA REDDY

K. Subrah
PRINCIPAL
MAHAVEER
INSTITUTE OF SCIENCE & TECHNOLOGY
Canklabad, Hyd-500 005.

Vysapuri, Bandlaguda Post: Keshavagiri,
Hyderabad-500005, TS, INDIA
Tel: 040-20020772, 20020773, Fax: 040-24455003
E-mail: e3hod.ece@gmail.com
Website: www.mist.ac.in

MAHAVEER

INSTITUTE OF SCIENCE & TECHNOLOGY
Approved by AICTE, Affiliated to JNTUH/Hyd



CERTIFICATE

This is to certify that the project work entitled "Development of Patient Monitoring System Using Smartphone" is submitted by

D.Shailaja

14E31A0413

K.Sai Harini

14E31A0423

In partial fulfillment of the requirements for the Degree of Bachelor of Technology in Electronics and Communication Engineering of Mahaveer Institute of Science and Technology, Hyderabad, during the academic year 2017-18, is a bonafide record of work carried out under our guidance and supervision. The results embodied in this report have not been submitted to any other university or Institution for the award of any degree or diploma.

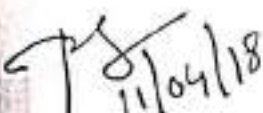
11/04/18
P.Sridhar
Assoc.Professor
Project Guide

Dr Jaspal Kumar
Professor
Project Coordinator

Dr P. Gnanasivam
Professor
Head of the Dept



External Examiner

External Examiner
Signature of External Examiner
Date: 11/04/18
Stamp: Mahaveer Institute of Science & Technology, Hyderabad



Certificate

This is to certify that

D. SHAILAJA REDDY

14E31A0413

K. SAI HARINI

14E31A0423

Students of final year B.Tech, Electronics and Communication Engineering, MAHAVEER INSTITUTE OF SCIENCE AND TECHNOLOGY, HYDERABAD (affiliated to J.N.T University, Hyderabad), have successfully completed their project titled "DEVELOPMENT OF PATIENT MONITORING SYSTEM USING SMART PHONE" in EMBEDDED SYSTEMS, CONSCIENCE TECHNOLOGIES (CT), Hyderabad.

For CONSCIENCE TECHNOLOGIES

Project Manager
B.V.K. Reddy
B.V. KRISHNA REDDY

K. S. MAHAVER
PRINCIPAL
MAHAVEER
INSTITUTE OF SCIENCE & TECHNOLOGY
20/2/2/2/2/2, Hyd-500 005.

Vysapuri, Bandlaguda Post: Keshavagiri,
Hyderabad-500005, TS, INDIA
Tel: 040-20020772, 20020773, Fax: 040-24455003
E-mail: e3hod.ece@gmail.com
Website: www.mist.ac.in

MAHAVEER



Approved by AICTE, Affiliated to JNTUHHyd

CERTIFICATE

This is to certify that the project work entitled "High-Speed and Low-Power VLSI-Architecture for Inexact Speculative Adder" is submitted by

K.Alekhya

Roll No.14E31A0430

CH.Prathiba

Roll No.14E31A0410

A.Archana

Roll No.14E31A0403

Alekhya
Prathiba
Archana

In partial fulfillment of the requirements for the Degree of Bachelor of Technology in Electronics and Communication Engineering of Mahaveer Institute of Science & Technology, Hyderabad, during the academic year 2017-18, is a bonafide record of work carried out under our guidance and supervision. The results embodied in this report have not been submitted to any other university or Institution for the award of any degree or diploma.

A.Laxman
Asst.Professor
Project Guide

Dr Jaspal Kumar
Professor
Project Coordinator

Dr P. Gnanasivam
Professor
Head of the Dept

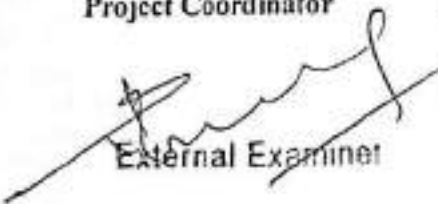
External Examiner



K. Srinivas
PRINCIPAL
MAHAVEER
INSTITUTE OF SCIENCE & TECHNOLOGY
Bandlaguda, Hyd-500 005.



Certificate

This is to certify that

K. ALEKHYA	14E31A0430
C. PRATHIBHA	14E31A0410
A. ARCHANA	14E31A0403

Students of final year B.Tech, Electronics and Communication Engineering, MAHAVEER INSTITUTE OF SCIENCE AND TECHNOLOGY, HYDERABAD (*affiliated to J.N.T.University, Hyderabad*), have successfully completed their project titled "HIGH SPEED AND LOW POWER VLSI ARCHITECTURE FOR IN EXACT SPECULATIVE ADDER" in VLSI DIVISION, CONSCIENCE TECHNOLOGIES (CT), Hyderabad.

For CONSCIENCE TECHNOLOGIES



Handwritten notes in blue ink, including the name 'Sudh' and some illegible text.

Vysapuri, Bandlaguda Post: Keshavagiri,
Hyderabad-500005, TS, INDIA
Tel: 040-20020772, 20020773, Fax: 040-24455003
E-mail: e3hod.ece@gmail.com
Website: www.mist.ac.in

MAHAVEER

INSTITUTE OF SCIENCE & TECHNOLOGY
Approved by AICTE, Affiliated to JNTU-Hyd



CERTIFICATE

This is to certify that the major project entitled "Internet of Things based energy aware smart home control systems" is submitted by

A.Shiva Prasad

P.Venkata Bharghav

B.Sai Kiran Yadav

Rijin Stalin

Roll No. 14E31A0406

Roll No. 14E31A0448

Roll No. 14E31A0408

Roll No. 14E31A0452

In partial fulfillment of the requirements for the Degree of Bachelor of Technology in Electronics & Communication Engineering of Mahaveer Institute of Science & Technology, Hyderabad, during the academic year 2017-18, is a bonafide record of work carried out under our guidance and supervision. The results embodied in this report have not been submitted to any other University or Institution for the award of any degree or diploma.

Ms. G. Roopa Lakshmi
Asst. Professor
Project Guide

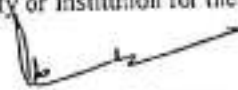
Dr. Jaspal Kumar
Professor
Project Coordinator

Dr. P. Gunasivaram
Professor
Head of the Dept.

External Examiner



PRINCIPAL
MAHAVEER
INSTITUTE OF SCIENCE & TECHNOLOGY
Bandlaguda, Hyd-500 005.



Certificate

This is to certify that

A. SHIVA PRASAD	14E31A0406
P. VENKATA BHARGHAV	14E31A0448
B. SAIKIRAN YADAV	14E31A0408
RIJIN STALIN	14E31A0452

Students of final year B.Tech, Electronics and Communication Engineering, MAHAVEER INSTITUTE OF SCIENCE AND TECHNOLOGY, HYDERABAD (affiliated to J.N.T.University, Hyderabad), have successfully completed their project titled "IOT BASED ENERGY AWARE SMART HOME CONTROL SYSTEMS" in EMBEDDED SYSTEMS, CONSCIENCE TECHNOLOGIES (CT), Hyderabad.

For CONSCIENCE TECHNOLOGIES

Project Manager

B.V. KRISHNA REDDY



PRINCIPAL
M. MAHAVEER
INSTITUTE OF SCIENCE & TECHNOLOGY
Bandlaguda, Hyd-500 005,

Address

#17-83/2C, 3rd Floor, Opp. Bank of Maharashtra,
Annapurna Function Hall Lane,
Bandlaguda, Hyderabad - 500005

Vysapuri, Bandlaguda Post: Keshavagiri,
Hyderabad-500005, TS, INDIA
Tel: 040-20020772, 20020773, Fax: 040-24455003
E-mail: e3hod.ece@gmail.com
Website: www.mist.ac.in

MAHAVEER

INSTITUTE OF SCIENCE & TECHNOLOGY
Approved by AKTE, Affiliated to JNTUHHyd



CERTIFICATE

This is to certify that the project work entitled "Iot Based Smart Robot using WIFI Module" is submitted by

K.Monika Reddy
L.Bhargavi
P.Navya
G.Vinay

Roll No. 14E31A0428 *W. Disha*
Roll No. 14E31A0431 *L. Bhargavi*
Roll No. 14E31A0446 *P. Navya*
Roll No. 14E31A0416 *G. Vinay*

In partial fulfillment of the requirements for the Degree of Bachelor of Technology in Electronics & Communication Engineering of Mahaveer Institute of Science & Technology, Hyderabad, during the academic year 2017-18, is a bonafide record of work carried out under our guidance and supervision. The results embodied in this report have not been submitted to any other University or Institution for the award of any degree or diploma.

M.A.K. Khan
Mr. M.A.K. Khan
Asst. Professor
Project Guide

Dr. Jaspal Kumar
Dr. Jaspal Kumar
Professor
Project Coordinator

Dr. P. Gnanasivam
Dr. P. Gnanasivam
Professor
Head of the Dept.



External Examiner
External Examiner

K. Srinivas
PRINCIPAL
MAHAVEER
INSTITUTE OF SCIENCE & TECHNOLOGY
HYD-500 005

Certificate

This is to certify that

K. MONIKA REDDY	14E31A0428
L. BHARGAVI	14E31A0431
P. NAVYA	14E31A0446
G. VINAY	14E31A0416

Students of final year B.Tech, Electronics and Communication Engineering, **MAHAVEER INSTITUTE OF SCIENCE AND TECHNOLOGY, HYDERABAD** (affiliated to *J.N.T. University, Hyderabad*), have successfully completed their project titled "IOT BASED SMART ROBOT USING WI FI MODULE" in **EMBEDDED SYSTEMS, CONSCIENCE TECHNOLOGIES (CT), Hyderabad.**

For **CONSCIENCE TECHNOLOGIES**

Project Manager

B.V. Krishna Reddy
B.V. KRISHNA REDDY

K. Anil
MAHAVEER INSTITUTE OF SCIENCE AND TECHNOLOGY
HYDERABAD

Vysapuri, Bandlaguda Post: Keshavgiri,
Hyderabad-500 005, TS, INDIA
Tel: 040-20020772,20020773,
Fax: 040-24455003
E-mail: e3hod.ece@gmail.com,
Website: www.mlst.ac.in

MAHAVEER



Approved by AICTE, Affiliated to JNTUH,Hyd.

CERTIFICATE

This is to certify that the project work entitled "Comparative Study of 16-order FIR Filter Design Using Different Multiplication Techniques" is submitted by

N.Sravanthi Reddy
N.Avanthi
Ily Sainath
V.Rajesh

Roll No. 14E31A0440
Roll No. 14E31A0439
Roll No. 14E31A0420
Roll No. 14E31A0458

Sravanthi
Avanthi
Sainath
Rajesh

In partial fulfillment of the requirements for the Degree of Bachelor of Technology in **Electronics & Communication Engineering** of Mahaveer Institute of Science & Technology, Hyderabad, during the academic year 2017-18, is a bonafide record of work carried out under our guidance and supervision.

The results embodied in this report have not been submitted to any other University or Institution for the award of any degree or diploma.



Mrs.H.Anita
Asst.Professor
Project Guide

Dr.Jaspal Kumar
Professor
Project Coordinator

Dr.P.Gnanasivam
Professor
Head of the Dept.

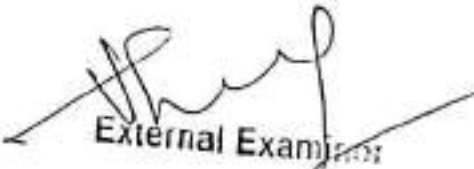

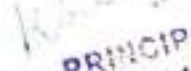
External Examiner

PRINCIPAL
MAHAVEER
INSTITUTE OF SCIENCE & TECHNOLOGY
Bandlaguda, Hyd-500 005.



Certificate

This is to certify that

N. SRAVANTHI REDDY	14E31A0440
N. AVANTHI	14E31A0439
ILY. SAINATH	14E31A0420
V. RAJESH	14E31A0458

Students of final year Diploma, Electronics and Communication Engineering, MAHAVEER INSTITUTE OF SCIENCE AND TECHNOLOGY, POLYTECHNIC HYDERABAD (*affiliated to J.N.T. University, Hyderabad*), have successfully completed their project titled "COMPARATIVE STUDY OF 16-ORDER FIR FILTER DESIGN USING DIFFERENT MULTIPLICATION TECHNIQUES" in VLSI, CONSCIENCE TECHNOLOGIES (CT), Hyderabad.

For CONSCIENCE TECHNOLOGIES

Project Manager

BVKReddy
B.V.KRISHNA REDDY

K. Suresh

Address

#17-83/2C, 3rd Floor, Opp. Bank of Maharashtra
Annapurna Function Hall Lane,
Dilsukhnagar, Hyderabad-500050

Vysapuri, Bandlaguda Post: Keshavagiri,
Hyderabad-500005, TS, INDIA
Tel: 040-20020772, 20020773, Fax: 040-24455003
E-mail: c.Mod.ece@gmail.com
Website: www.mist.ac.in

MAHAVEER



Approved by AICTE, Affiliated to JNTU-Hyd

CERTIFICATE

This is to certify that the project work entitled "Approximate Error Detection with Stochastic Checkers" is submitted by

P.Akhil Reddy
A.Abhilash Reddy
Kollaru.Vinay Raja
P.Shiva Kumar
P.Sai Bhavan

Roll No. 14E31A0441
Roll No. 14E31A0401
Roll No. 14E31A0427
Roll No. 14E31A0443
Roll No. 14E31A0447

P. Akhil Reddy
Abhilash
Vinay Raja
P. Shiva
Sai Bhavan

In partial fulfillment of the requirements for the Degree of Bachelor of Technology in Electronics & Communication Engineering of Mahaveer Institute of Science & Technology, Hyderabad, during the academic year 2017-18, is a bonafide record of work carried out under our guidance and supervision. The results embodied in this report have not been submitted to any other University or Institution for the award of any degree or diploma.

S. Soujanya
Ms.S.Soujanya
Asst.Professor
Project Guide

[Signature]
Dr.Jaspal Kumar
Professor
Project Coordinator

[Signature]
Dr.P.Gnahasivam
Professor
Head of the Dept.

[Signature]
External Examiner



[Signature]
PRINCIPAL
MAHAVEER
INSTITUTE OF SCIENCE & TECHNOLOGY
B-17, Bandlaguda, Hyd-500 005.



Certificate

This is to certify that

P. AKHIL REDDY	14E31A0441
A. ABHILASH REDDY	14E31A0401
KOLLURU. VINAY RAJA	14E31A0427
P. SHIVA KUMAR	14E31A0443
P. SAI BHAVAN	14E31A0447

Students of final year B.Tech, Electronics and Communication Engineering, MAHAVEER INSTITUTE OF SCIENCE AND TECHNOLOGY, HYDERABAD (*affiliated to J.N.T. University, Hyderabad*), have successfully completed their project titled "APPROXIMATE ERROR DETECTION WITH STOCHASTIC CHECKERS" in VLSI DIVISION, CONSCIENCE TECHNOLOGIES (CT), Hyderabad.

For CONSCIENCE TECHNOLOGIES

Project Manager

B.V. KRISHINA REDDY

Handwritten signature

Address

#17-83/2C, 3rd Floor, Opp. Bank of Maharashtra,
Annajouma Junction, Hall Line.

Vysapuri, Randlaguda Post: Keshavagiri,
Hyderabad-500005, TS, INDIA
Tel: 040-20020772, 20020773, Fax: 040-24455003
E-mail: v3mod.ecce@gmail.com
Website: www.mist.ac.in

MAHAVEER

Approved by AICTE, Affiliated to JNTUHR



CERTIFICATE

This is to certify that the project work entitled "Compressor Based 16x16 Vedic Multiplier Using Reversible Logic Gates" is submitted by

V.Laxmi Prasanna
K.Naveen Kumar
C.Vinay Kumar Chary
Y.Harish

Roll No. 14E31A0449
Roll No. 14E31A0422
Roll No. 14E31A0411
Roll No. 14E31A0460

V. Laxmi Prasanna
K. Naveen Kumar
C. Vinay Kumar Chary
Y. Harish

In partial fulfillment of the requirements for the Degree of Bachelor of Technology in Electronics & Communication Engineering of Mahaveer Institute of Science & Technology, Hyderabad, during the academic year 2017-18, is a bonafide record of work carried out under our guidance and supervision. The results embodied in this report have not been submitted to any other University or Institution for the award of any degree or diploma.

Mr. K. Venkateshwarlu
Asst. Professor
Project Guide

Dr. Jaspal Kumar
Professor
Project Coordinator

Dr. P. Gnanesivani
Professor
Head of the Dept.



External Examiner

K. Subh
PRINCIPAL
MAHAVEER
INSTITUTE OF SCIENCE & TECHNOLOGY
HYDERABAD, 500005.



Certificate

This is to certify that

V. LAXMI PRASANNA	14E31A0449
K. NAVEEN KUMAR	14E31A0422
C. VINAY KUMAR CHARY	14E31A0411
Y. HARISH	14E31A0460

Students of final year B.Tech, Electronics and Communication Engineering, MAHAVEER INSTITUTE OF SCIENCE AND TECHNOLOGY, HYDERABAD (*affiliated to J.N.T. University, Hyderabad*), have successfully completed their project titled "COMPRESSOR BASED 16*16 BIT VEDIC MULTIPLIER USING REVERSIBLE LOGIC GATES" in VLSI DIVISION, CONSCIENCE TECHNOLOGIES (CT), Hyderabad.

For CONSCIENCE TECHNOLOGIES



Handwritten signature
MAHAVEER INSTITUTE OF SCIENCE AND TECHNOLOGY
HYDERABAD



MAHAVEER INSTITUTE OF SCIENCE & TECHNOLOGY

(Affiliated to JNTU Hyderabad, Approved by AICTE)
Vyasapuri, Bandlaguda, Post: Keshavagiri
Hyderabad -500 005

CERTIFICATE

This is to certify that main project based on "AVR BASED CAR PARKING SYSTEM" of the Electronics and Communication Engineering course which is being submitted by

CIL.GOPINATH	11E31A0473
D.SHARATH	11E31A0474
D.VENKATESH	11E31A0475
D.GOUTHAMI	11E31A0476
D.NAGA DIVYA	11E31A0477

In partial fulfillment for the award of Degree of Bachelor of Technology in Electronics and Communication Engineering to the Mahaveer Institute of Science and Technology, affiliated to Jawaharlal Technological University and is a bonafide record of work carried out by them under our supervision during the academic year 2014-2015.



GUIDE

.Ravi kumar
Assistant Professor

COORDINATOR

Mrs. Shaik Gulnaz
Assistant Professor

COORDINATOR

Dr. V. Gunshelar Reddy
Professor

HEAD OF DEPT.

Dr. B. Visvesvara Rao
Professor & HOD

PRINCIPAL
MAHAVEER
INSTITUTE OF SCIENCE & TECHNOLOGY
Bandlaguda, Hyd-500 005



Certificate

hereby certifies that

CHINTHA GOPINATH

has participated in Main Project Development Program at
MAHAVEER INSTITUTE OF SCIENCE & TECHNOLOGY

in ECE final year held during

02 Feb '15 - 14 Mar '15

Training Partners



K. Srinivas
20/02/2015
Principal
Mahaiveer Institute of Science & Technology
Hyderabad, Andhra Pradesh

A handwritten signature in black ink, appearing to read 'Gayatri', is written over a horizontal line.

Course Director





Certificate

hereby certifies that

D SHARATH KUMAR

has participated in Main Project Development Program at

MAHAVEER INSTITUTE OF SCIENCE & TECHNOLOGY

in ECE final year held during

02 Feb '15 - 14 Mar '15

Training Partners



ESTD : 2001

K. S. S. S.
PRINCIPAL
MAHAVEER
INSTITUTE OF SCIENCE & TECHNOLOGY
Bandlaguda, Hyd-500 005.

G. S. S. S.

Course Director



Certificate

hereby certifies that

D.GOUTHAMI

has participated in Main Project Development Program at
MAHAVEER INSTITUTE OF SCIENCE & TECHNOLOGY

in ECE final year held during

02 Feb '15 - 14 Mar '15

Training Partners



ESTD : 2001

K. Srinivas
PRINCIPAL
MAHAVEER
INSTITUTE OF SCIENCE & TECHNOLOGY
HYDERABAD, T.S.R.

Gayatri

Course Director



Certificate

hereby certifies that

D.NAGA DIVYA

has participated in Main Project Development Program at
MAHAVEER INSTITUTE OF SCIENCE & TECHNOLOGY

in ECE final year held during

02 Feb '15 - 14 Mar '15

Training Partners



ESTD : 2001

K. Srinivas

PRINCIPAL
MAHAVEER
 INSTITUTE OF SCIENCE & TECHNOLOGY
 Bandlaguda, Hyd-500 005.

Gayatri

Course Director





Certificate

hereby certifies that

DEVARAKONDA VENKATESH

has participated in Main Project Development Program at
MAHAVEER INSTITUTE OF SCIENCE & TECHNOLOGY

in ECE final year held during

02 Feb '15 - 14 Mar '15

Training Partners



ESTD : 2001

K. Srinivas
Principal
Maha Veer Institute of Science & Technology
Hyderabad, 500 002, India

Gayatri

Course Director

MAHAVEER INSTITUTE OF SCIENCE & TECHNOLOGY

Vyasapuri, Bandlaguda, Post: Keshavgiri, Hyderabad – 500 005

2013– 2014



CERTIFICATE

This is to certify that the Major Project report title "RFID BASED CONTROLLING HOME APPLIANCES" is submitted by

B.SANDEEP REDDY	11E31A0468
B.DURGAPRASAD	11E31A0469
B.SHILPA	11E31A0470
C.MOUNIKA	11E31A0471
CH.KARTHIK	11E31A0472

In partial fulfillment for the award of Degree of Bachelor of Technology in Electronics and Communication Engineering to the Mahaveer Institute of Science and Technology, affiliated to Jawaharlal Nehru Technological University and is a bonafide record of work carried out by them under our supervision during the academic year 2013-2014.

The results embodied in this major project have not been submitted to any other University or Institute for the award of any degree or diploma.

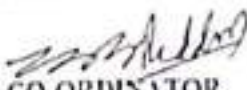

GUIDE
Mr.P.Ravi Kumar
Asst.Prof

CO-ORDINATOR
Mrs. Shaik Gulnaz
Asst.Prof

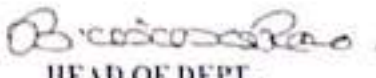
CO-ORDINATOR
Dr. V.Gunashekar Reddy
Professor

HEAD OF DEPT.
Dr.B.VisvesvaraRao
Professor&HOD

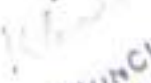

PRINCIPAL
MAHAVEER
INSTITUTE OF SCIENCE & TECHNOLOGY
Bandlaguda, Hyd-500 005.



Certificate

hereby certifies that

BATHULA SANDEEP REDDY

has participated in Main Project Development Program at

MAHAVEER INSTITUTE OF SCIENCE & TECHNOLOGY

in ECE final year held during

02 Feb '15 - 14 Mar '15

Training Partners



ESTD : 2001

Handwritten signature in green ink.
 MAHAVEER INSTITUTE OF SCIENCE & TECHNOLOGY
 HYDERABAD

Handwritten signature in black ink.

Course Director



Certificate

hereby certifies that

B.DURGA PRASAD

has participated in Main Project Development Program at

MAHAVEER INSTITUTE OF SCIENCE & TECHNOLOGY

in ECE final year held during

02 Feb '15 - 14 Mar '15

Training Partners



ESTD : 2001

K. S. Reddy

PRINCIPAL
MAHAVEER
INSTITUTE OF SCIENCE & TECHNOLOGY
Banjara Hills, Hyd-500 005.

Gayatri

Course Director



Certificate

hereby certifies that

C.MOUNIKA

has participated in Main Project Development Program at
MAHAVEER INSTITUTE OF SCIENCE & TECHNOLOGY

in ECE final year held during

02 Feb '15 - 14 Mar '15

Training Partners



ESTD : 2001

Gayatri

Course Director



Certificate

hereby certifies that

B.SHILPA

has participated in Main Project Development Program at

MAHAVEER INSTITUTE OF SCIENCE & TECHNOLOGY

in ECE final year held during

02 Feb '15 - 14 Mar '15

Training Partners



ESTD : 2001

PRINCIPAL
MAHAVEER
INSTITUTE OF SCIENCE & TECHNOLOGY
Bandlaguda, Hyd-500 005.



Course Director



Certificate

hereby certifies that

CH. KARTHIK

has participated in Main Project Development Program at

MAHAVEER INSTITUTE OF SCIENCE & TECHNOLOGY

in ECE final year held during

02 Feb '15 - 14 Mar '15

Chand

Training Partners



ESTD : 2001

PRINCIPAL
MAHAVEER
INSTITUTE OF SCIENCE & TECHNOLOGY
Bansalaguda, Hyd-500 005.

Gayatri

Course Director

MAHAVEER INSTITUTE OF SCIENCE AND TECHNOLOGY
(Affiliated to JNTU Hyderabad and approved by AICTE)
Vyasapuri, Bandlaguda, Post: Keshavgiri,
Hyderabad- 500 005



ESTD : 2001

CERTIFICATE

This is to certify that a Major-Project report titled WIRELESS SECURITY SYSTEM is submitted by

MD.SHARIQ	11E31A0493
N.NARESH	11E31A0494
N.SINDUJA	11E31A0495
N. SRIKANTH	11E31A0496
P.KARTHIK REDDY	11E31A0497



In partial fulfilment for the award of Degree of Bachelor of Technology in Electronics and Communication Engineering to the Mahaveer Institute of Science and Technology, affiliated to Jawaharlal Nehru Technological University and is a bonafide record of work carried out by them under our supervision during 2014-2015.

The results embodied in this project report have not been submitted to any other University or Institute for the award of any degree or diploma.

Mr. B. Ramana Kumar
GUIDE
Mr. B. Ramana Kumar
Associate Professor

Mrs. Shaik Gulnaz
CO-ORDINATOR
Mrs. Shaik Gulnaz
Asst. Professor

Dr. V. Gunashekar Reddy
CO-ORDINATOR
Dr. V. Gunashekar Reddy
Professor

Dr. B. Visvesvara Rao
HEAD OF DEPT.
Dr. B. Visvesvara Rao
Professor & HOD

K. Srinivas
PRINCIPAL
MAHAVEER
INSTITUTE OF SCIENCE & TECHNOLOGY
Bandlaguda, Hyd-500 005.



Certificate

hereby certifies that

MOHAMMED SHARIQ

has participated in Main Project Development Program at
MAHAVEER INSTITUTE OF SCIENCE & TECHNOLOGY

in ECE final year held during

02 Feb '15 - 14 Mar '15

Training Partners



ESTD : 2001

Sulek
PRINCIPAL
MAHAVEER
INSTITUTE OF SCIENCE & TECHNOLOGY
Banjara Hills, Hyd-500 005.

Course Director



Certificate

hereby certifies that

NALLALA NARESH

has participated in Main Project Development Program at
MAHAVEER INSTITUTE OF SCIENCE & TECHNOLOGY

in ECE final year held during

02 Feb '15 - 14 Mar '15

Training Partners



ESTD : 2001

K. Sankar
PRINCIPAL
MAHAVEER
INSTITUTE OF SCIENCE & TECHNOLOGY
Bandlaguda, Hyd-500 005.

Gayatri

Course Director



Certificate

hereby certifies that

N.SINDHUJA

has participated in Main Project Development Program at
MAHAVEER INSTITUTE OF SCIENCE & TECHNOLOGY

in ECE final year held during

02 Feb '15 - 14 Mar '15

Training Partners



ESTD : 2001

Khanal
PRINCIPAL
MAHAVEER
INSTITUTE OF SCIENCE & TECHNOLOGY
Bhadrachalam, Hyd-500 005.

Gayatri

Course Director



Certificate

hereby certifies that

N.SRIKANTH

has participated in Main Project Development Program at

MAHAVEER INSTITUTE OF SCIENCE & TECHNOLOGY

in ECE final year held during

02 Feb '15 - 14 Mar '15

Training Partners



ESTD : 2001

K. Sankar
PRINCIPAL
MAHAVEER INSTITUTE OF SCIENCE & TECHNOLOGY
HYDERABAD

Gayatri

Course Director

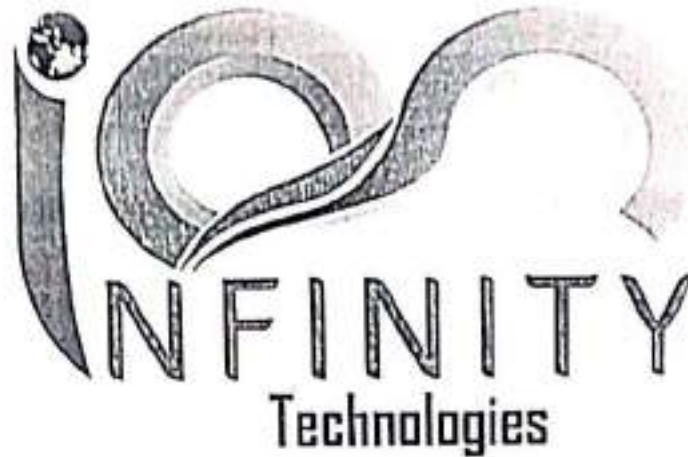

Certificate

hereby certifies that

P.KARTHIK REDDY

has participated in Main Project Development Program at

MAHAVEER INSTITUTE OF SCIENCE & TECHNOLOGY

in ECE final year held during

02 Feb '15 - 14 Mar '15

Training Partners



ESTD : 2001

K. Srinivas
PRINCIPAL
MAHAVEER
INSTITUTE OF SCIENCE & TECHNOLOGY
Banallaguda, Hyd-500 005.

Gayatri

Course Director

MAHAVEER INSTITUTE OF SCIENCE AND TECHNOLOGY
(Affiliated to JNTU Hyderabad and approved by AICTE)
Vyasapuri, Bandlaguda, Post: Keshavgi,
Hyderabad- 500 005



CERTIFICATE

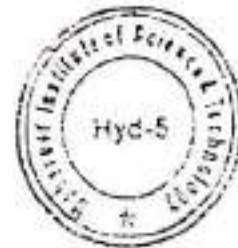

This is to certify that a Major-Project report titled **OBJECT AVOIDER** is submitted by

T.MAHESH	11E31A04B5
T.RAJU	11E31A04B6
V.RAJESH	11E31A04B7
V.SANDEEP	11E31A04B8
V.PRASHANTH BABU	11E31A04B9

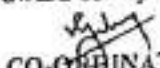

In partial fulfilment for the award of Degree of Bachelor of Technology in Electronics and Communication Engineering to the Mahaveer Institute of Science and Technology, affiliated to Jawaharlal Nehru Technological University and is a bonafide record of work carried out by them under our supervision during 2014-2015.

The results embodied in this project report have not been submitted to any other University or Institute for the award of any degree or diploma.

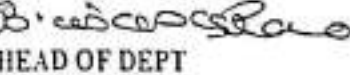
 GUIDE	 CO-ORDINATOR	 CO-ORDINATOR	 HEAD OF DEPT
Ms.D.SUNITHA Asst.Prof	Mrs.Shah Gulnaz Asst.Prof	Dr.V.Gunashakar Reddy Professor	Dr.B.Visvesvara Rao Professor&HOD

PRINCIPAL
MAHAVEER
INSTITUTE OF SCIENCE & TECHNOLOGY
Bandlaguda, Hyd-500 005.



Certificate

hereby certifies that

T.MAHESH

has participated in Main Project Development Program at
MAHAVEER INSTITUTE OF SCIENCE & TECHNOLOGY

in ECE final year held during

02 Feb '15 - 14 Mar '15

Training Partners



ESTD : 2001

Principal
MAHAVEER INSTITUTE OF SCIENCE & TECHNOLOGY
Hyderabad - 500007

Gayatri

Course Director



Certificate

hereby certifies that

T.RAJU

has participated in Main Project Development Program at

MAHAVEER INSTITUTE OF SCIENCE & TECHNOLOGY

in ECE final year held during

02 Feb '15 - 14 Mar '15

Training Partners



ESTD : 2001

K. Sankar
PRINCIPAL
MAHAVEER
INSTITUTE OF SCIENCE & TECHNOLOGY
Bandlaguda, Hyd-500 005.

Gayatri

Course Director



Certificate

hereby certifies that

V. RAJESH

has participated in Main Project Development Program at
MAHAVEER INSTITUTE OF SCIENCE & TECHNOLOGY

in ECE final year held during

02 Feb '15 - 14 Mar '15

Training Partners



ESTD : 2001

K. Sankar
PRINCIPAL
MAHAVEER INSTITUTE OF SCIENCE & TECHNOLOGY
ELECTRONICS & TELECOMMUNICATIONS
HYDRABAD - 500082

Ganaprasad

Course Director



Certificate

hereby certifies that

V.SANDEEP

has participated in Main Project Development Program at
MAHAVEER INSTITUTE OF SCIENCE & TECHNOLOGY

in ECE final year held during

02 Feb '15 - 14 Mar '15

Training Partners



ESTD : 2001

Sanjay
PRINCIPAL
MAHAVEER
INSTITUTE OF SCIENCE & TECHNOLOGY
Bandlaguda, Hyd-500 005.

Course Director



Certificate

hereby certifies that

V.PRASHANTH BABU

has participated in Main Project Development Program at
MAHAVEER INSTITUTE OF SCIENCE & TECHNOLOGY

in ECE final year held during

02 Feb '15 - 14 Mar '15

Training Partners



ESTD : 2001

Winkles
PRINCIPAL
MAHAVEER
INSTITUTE OF SCIENCE & TECHNOLOGY
Banjara Hills, Hyderabad

Gayatri

Course Director

MAHAVEER INSTITUTE OF SCIENCE AND TECHNOLOGY

(Affiliated to JNTU Hyderabad, Approved by AICTE)

Vyasapuri, Bandlaguda, Post: Keshavnagar

Hyderabad - 500 005



CERTIFICATE

This is to certify that the Main-Project report titled "WIRELESS HOME APPLIANCES USING RF434 MODULE" is submitted by

A.SANDEEP KUMAR	11E31A0462
AMIT MISRA	11E31A0463
A.SAI PRANEETH	11E31A0464
B.S.RAJESH	11E31A0465
B.VIJAY KUMAR	11E31A0466

In partial fulfillment for the award of Degree of Bachelor of Technology in Electronics and Communication Engineering to the Mahaveer Institute of Science and Technology, affiliated to Jawaharlal Nehru Technological University and is a bonafide record work carried out by them under our supervision during the academic year 2014-2015.

The results embodied in this project report have not been submitted to any other University or Institute for the award of any degree or diploma.



GUIDE
Dr. B. Visvesvara Rao
Professor & HOD



CO-ORDINATOR
Mrs. Shaik Gulnaz
Asst. Professor



CO-ORDINATOR
Dr. V. Gunashekar Reddy
Professor



HEAD OF DEPT
Dr. B. Visvesvara Rao
Professor & HOD



PRINCIPAL
MAHAVEER
INSTITUTE OF SCIENCE & TECHNOLOGY
Bandlaguda, Hyd-500 005



Certificate

hereby certifies that

A.SANDEEP

has participated in Main Project Development Program at

MAHAVEER INSTITUTE OF SCIENCE & TECHNOLOGY

in ECE final year held during

02 Feb '15 - 14 Mar '15

Training Partners



ESTD : 2001

K. Sankar

DR. K. SANKAR
PROFESSOR
INSTITUTE OF SCIENCE & TECHNOLOGY
HYDRABAD

Gayatri

Course Director

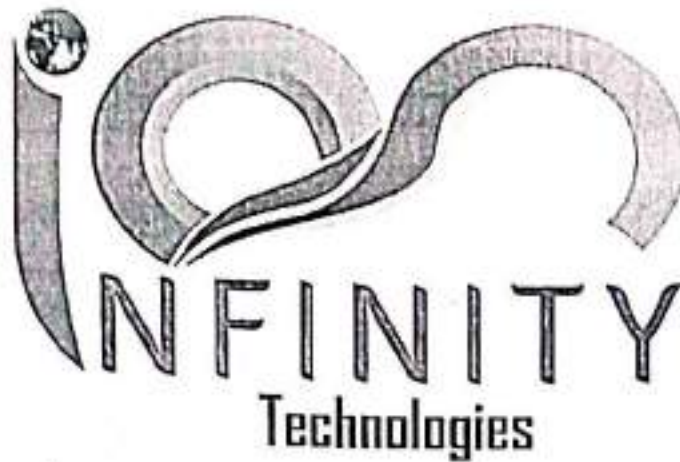

Certificate

hereby certifies that

AMIT MISHRA

has participated in Main Project Development Program at
MAHAVEER INSTITUTE OF SCIENCE & TECHNOLOGY

in ECE final year field during

02 Feb '15 - 14 Mar '15

Training Partners



ESTD : 2001

Chakraborty
PRINCIPAL
MAHAVEER
INSTITUTE OF SCIENCE & TECHNOLOGY
Bandlaguda, Hyd-500 005.

Course Director



Certificate

hereby certifies that

A.SAI PRANEETH

has participated in Main Project Development Program at

MAHAVEER INSTITUTE OF SCIENCE & TECHNOLOGY

in T.C.E. final year held during

02 Feb '15 - 14 Mar '15

Training Partners



ESTD : 2001

K. Srinivas
PRINCIPAL
MAHAVEER
INSTITUTE OF SCIENCE & TECHNOLOGY
BANGALORE, KARNATAKA

Gayatri

Course Director

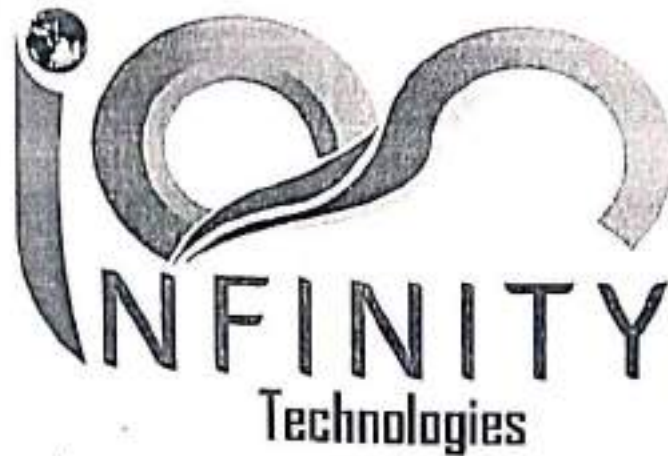

Certificate

hereby certifies that

BS RAJESH

has participated in Main Project Development Program at

MAHAVEER INSTITUTE OF SCIENCE & TECHNOLOGY

in ECE final year held during

02 Feb '15 - 14 Mar '15

Training Partners



ESTD : 2001

Gayatri

Course Director

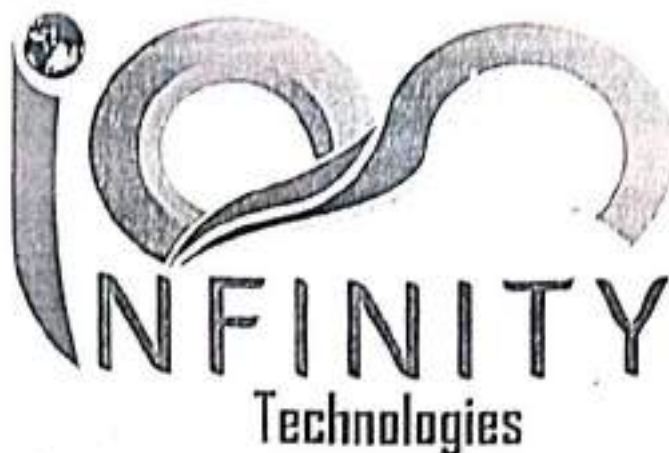

Certificate

hereby certifies that

B VIJAYKUMAR

has participated in Main Project Development Program at
MAHAVEER INSTITUTE OF SCIENCE & TECHNOLOGY

in ECE final year held during

02 Feb '15 - 14 Mar '15

Training Partners



ESTD : 2001

PRINCIPAL
MAHAVEER
INSTITUTE OF SCIENCE & TECHNOLOGY
Bandlaguda, Hyd-500 005.

Course Director

MAHAVEER INSTITUTE OF SCIENCE AND TECHNOLOGY
(Affiliated to JNTU Hyderabad and approved by AICTE)
Vyasapuri, Bandlaguda, Post: Keshavgi,
Hyderabad- 500 005



CERTIFICATE

This is to certify that the project titled **MOTION CONTROLLED ROBOT** is submitted
by

J.NIKHIL,	11E31A0483
K.ASHWITHA REDDY	11E31A0484
K.SAMHITHA REDDY	11E31A0485
K.SUNITHA	11E31A0486
K.RAKESH	11E31A0487

in partial fulfillment for the award of the Degree of Bachelor of Technology in
Electronics and Communication Engineering to the Jawaharlal Nehru Technological
University, Hyderabad, during the year 2014-2015 and is a bonafide project work
carried out under our supervision.

The results embodied in this project work has not been submitted
to any other University for the award of any degree or diploma.

Handwritten signature
MAHAVEER INSTITUTE OF SCIENCE AND TECHNOLOGY
VYASAPURI, BANDLAGUDA, HYDERABAD - 500 005

Handwritten signature
GUIDE
Mrs.V.Himaja
Asst.Professor

Handwritten signature
CO-ORDINATOR
Mrs. Shaik Gulnaz
Asst.Professor

Handwritten signature
CO-ORDINATOR
Dr. V.Gunashakar Reddy
Professor

Handwritten signature
HEAD OF DEPT
Dr.B.VisvesvaraRao
Professor & HOD





Certificate

hereby certifies that

J.NIKHIL

has participated in Main Project Development Program at
MAHAVEER INSTITUTE OF SCIENCE & TECHNOLOGY

in ECE final year held during

02 Feb '15 - 14 Mar '15

Training Partners



ESTD : 2001

K.S. Subramanian

Course Director



Certificate

hereby certifies that

KASHWITHA

has participated in Main Project Development Program at
MAHAVEER INSTITUTE OF SCIENCE & TECHNOLOGY

in ECE final year held during

02 Feb '15 - 14 Mar '15

Training Partners



ESTD : 2001

PRINCIPAL
MAHAVEER
INSTITUTE OF SCIENCE & TECHNOLOGY
Bandlaguda, Hyd-500 005.

Course Director



Certificate

hereby certifies that

K.SUNITHA

has participated in Main Project Development Program at
MAHAVEER INSTITUTE OF SCIENCE & TECHNOLOGY

in ECE final year held during

02 Feb '15 - 14 Mar '15

Training Partners



ESTD : 2001

K. Srinivas
Principal
MAHAVEER INSTITUTE OF SCIENCE & TECHNOLOGY
INSTITUTE OF SCIENCE & TECHNOLOGY
PACHAULI, HYDRABAD

Gayatri

Course Director



Certificate

hereby certifies that

KANAKANTI RAKESH

has participated in Main Project Development Program at

MAHAVEER INSTITUTE OF SCIENCE & TECHNOLOGY

in ECE final year held during

02 Feb '15 - 14 Mar '15

Training Partners



ESTD : 2001

K. Sanku
PRINCIPAL
MAHAVEER
INSTITUTE OF SCIENCE & TECHNOLOGY
Bandlaguda, Hyd-500 005.

Gayatri

Course Director

MAHAVEER INSTITUTE OF SCIENCE AND TECHNOLOGY
(Affiliated to JNTU Hyderabad and approved by AICTE)
Vyasapuri, Bandlaguda, Post: Keshavgiri,
Hyderabad- 500 005



CERTIFICATE

This is to certify that the Main - Project report titled
"PICK AND PLACE ROBOT" is submitted by

P.GANGYA NAIK
H.PRAKASH
R.MADHU KUMARI
RESHMA
S.SRINU

11E31A04A4
11E31A04A5
11E31A04A6
11E31A04A7
11E31A04A8



In partial fulfillment for the award of the Degree of Bachelor of Technology in Electronics and Communication Engineering in the Mahaveer Institute of Science and Technology, affiliated to the Jawaharlal Nehru Technological University and is a benefit record of work carried out by them under our supervision during the academic year

2014-2015.

The results embodied in this project report has not been submitted to any other University or Institute for the award of any degree or diploma.

GUIDE

Mrs.G.Rajyn Laxmi
Asst.Professor

CO-ORDINATOR

Mrs.Shaik Gulnaz
Asst.Professor

CO-ORDINATOR

Dr.V.Gunashekar Reddy
Professor

HEAD OF DEPT.

Dr.B.Visvesvaran Rao
Professor & HOD

PRINCIPAL
MAHAVEER
INSTITUTE OF SCIENCE & TECHNOLOGY
Bandlaguda, Hyd-500 005.



Certificate

hereby certifies that

P.GANGYA NAIK

has participated in Main Project Development Program at
MAHAVEER INSTITUTE OF SCIENCE & TECHNOLOGY

in ECE final year held during

02 Feb '15 - 14 Mar '15

Training Partners



ESTD : 2001

K. Srinivas
PRINCIPAL
MAHAVEER INSTITUTE OF SCIENCE & TECHNOLOGY
Badrachalam, Medchal, R.R. 100

Gangya Naik

Course Director



Certificate

hereby certifies that

PRAKASH HANJNALE

has participated in Main Project Development Program at
MAHAVEER INSTITUTE OF SCIENCE & TECHNOLOGY

in ECE final year held during

02 Feb '15 - 14 Mar '15

Training Partners



ESTD : 2001

Suby
PRINCIPAL
MAHAVEER
INSTITUTE OF SCIENCE & TECHNOLOGY
Banerajuda, Hyd-500 005.

Course Director



Certificate

hereby certifies that

RAJPUT MADHUKUMARI

has participated in Main Project Development Program at
MAHAVEER INSTITUTE OF SCIENCE & TECHNOLOGY

in ECE final year field during

02 Feb '15 - 14 Mar '15

Training Partners



K. Srinivas
Principal
MIST
MIST
MIST

Gayatri

Course Director



Certificate

hereby certifies that

S.SRINU

has participated in Main Project Development Program at

MAHAVEER INSTITUTE OF SCIENCE & TECHNOLOGY

in ECE final year held during

02 Feb '15 - 14 Mar '15

Training Partners



ESTD : 2001

PRINCIPAL
MAHAVEER
INSTITUTE OF SCIENCE & TECHNOLOGY
Bandlaguda, Hyd-500 005.

Course Director



Certificate

hereby certifies that

RESHMA

has participated in Main Project Development Program at
MAHAVEER INSTITUTE OF SCIENCE & TECHNOLOGY

in ECE final year held during

02 Feb '15 - 14 Mar '15

Training Partners



ESTD : 2001

Handwritten signature in blue ink

Handwritten signature in black ink

Course Director

MAHAVEER INSTITUTE OF SCIENCE AND TECHNOLOGY

(Affiliated to JNTU Hyderabad, Approved by AICTE)

Vyasapuri, Bandlaguda, Post: Keshavagiri

Hyderabad - 500 005



CERTIFICATE

This is to certify that the Main-Project report titled **COMPUTER CONTROLLED OBJECT** is submitted by

V.SAHITHI	11E31A04C0
P.KRISHNAM RAJU	12E35A0415
MD.AMURUDDIN	12E35A0416
R.AMARESH	12E35A0417
M.JAVEED JAFAR	12E35A0418

In partial fulfillment for the award of Degree of Bachelor of Technology in Electronics and Communication Engineering to the Mahaveer Institute of Science and Technology, affiliated to Jawaharlal Nehru Technological University during the year 2014-2015.

The results embodied in this project report have not been submitted to any other University or institute for the award of any degree or diploma.

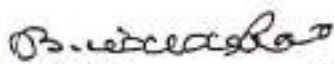
GUIDE

Dr. B. Visvesvara Rao
prof and HOD

CO-ORDINATOR

Mrs. Shaik Gulnaz
Asst. Prof

CO-ORDINATOR

Dr. V. Gunashekar Reddy
Professor

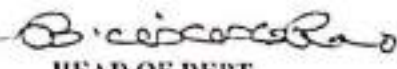
HEAD OF DEPT

Dr. B. Visvesvara Rao
Prof and HOD



PRINCIPAL
MAHAVEER
INSTITUTE OF SCIENCE & TECHNOLOGY
Bandlaguda, Hyd-500 005.



Certificate

hereby certifies that

V.SAHITHI

has participated in Main Project Development Program at

MAHAVEER INSTITUTE OF SCIENCE & TECHNOLOGY

in ECE final year held during

02 Feb '15 - 14 Mar '15

Training Partners



ESTD : 2001

K. Subh

Principal
MIST
Mahaveer Institute of Science & Technology
Nandlaguda, Hyderabad

Gayatri

Course Director



Certificate

hereby certifies that

P.KRISHNAM RAJU

has participated in Main Project Development Program at
MAHAVEER INSTITUTE OF SCIENCE & TECHNOLOGY

in ECE final year held during

02 Feb '15 - 14 Mar '15

Training Partners



ESTD : 2001

Handwritten signature
PRINCIPAL
MAHAVEER
INSTITUTE OF SCIENCE & TECHNOLOGY
Banjara Hills, Hyd-500 005.

Handwritten signature

Course Director

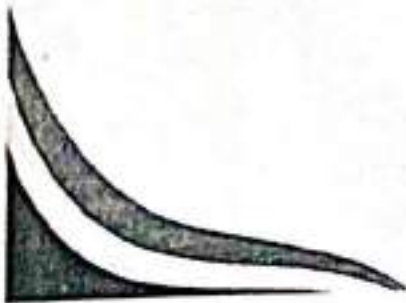

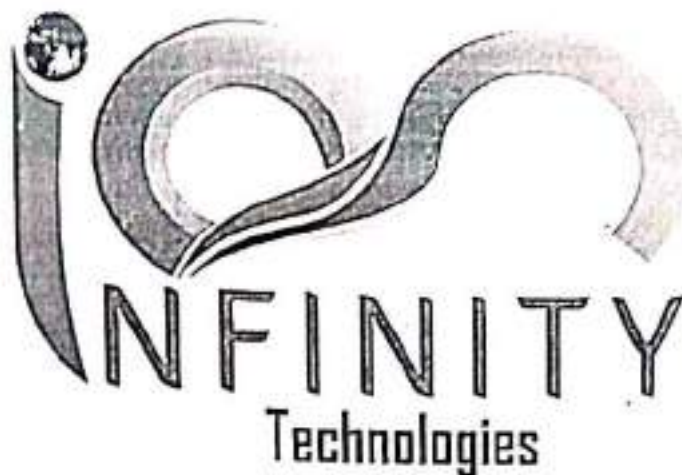

Certificate

hereby certifies that

MD.AMURUDDIN

has participated in Main Project Development Program at
MAHAVEER INSTITUTE OF SCIENCE & TECHNOLOGY

in ECE final year held during

02 Feb '15 - 14 Mar '15

Training Partners



ESTD : 2001

PRINCIPAL
MAHAVEER
INSTITUTE OF SCIENCE & TECHNOLOGY
Bandlaguda, Hyd-500 005.

Course Director

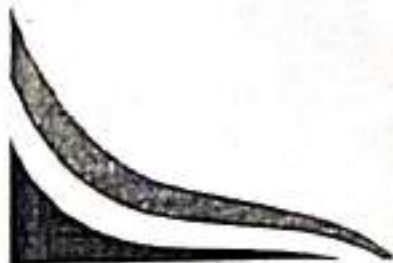



Certificate

hereby certifies that

R. AMARESH

has participated in Main Project Development Program at

MAHAVEER INSTITUTE OF SCIENCE & TECHNOLOGY

in ECE final year field during

02 Feb '15 - 14 Mar '15

Training Partners



ESTD : 2001

K. Srinivas
PRINCIPAL
MAHAVEER
INSTITUTE OF SCIENCE & TECHNOLOGY
BAROBA, HYDRABAD

Ganesh

Course Director

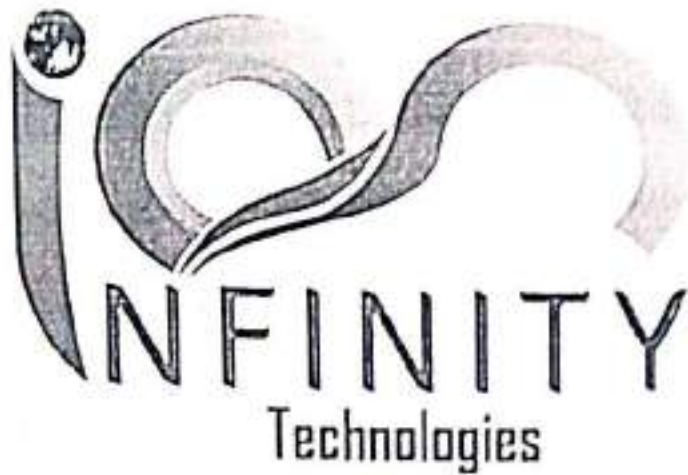

Certificate

hereby certifies that

M.JAVEED

has participated in Main Project Development Program at
MAHAVEER INSTITUTE OF SCIENCE & TECHNOLOGY

in ECE final year held during

02 Feb '15 - 14 Mar '15

Training Partners



ESTD : 2001

11/02/2015 10:00:00 AM
PRINCIPAL
MAHAVEER
INSTITUTE OF SCIENCE & TECHNOLOGY
Bandlaguda, Hyd-500 005.

Course Director

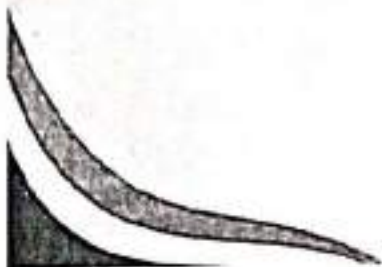

Vyasapuri, Bandlaguda, Post: Keshavgiri,
Hyderabad- 500 005



CERTIFICATE

This is to certify that the project titled "RFID BASED SECURITY SYSTEM" is submitted by

G.GIRIJA	11E35A0414
SYED. M. SUBHANI	12E35A0419
D.GOVIND RAO	12E35A0420
T.SESHADRI	12E35A0421
B.SHRAVAN KUMAR	12E35A0422

in partial fulfillment for the award of the Degree of Bachelor of Technology in Electronics and Communication Engineering to the Jawaharlal Nehru Technological University, Hyderabad, during the year 2014-2015 and is a bonafide project work carried out under our supervision.

The results embodied in this project work has not been submitted to any other University for the award of any degree or diploma.

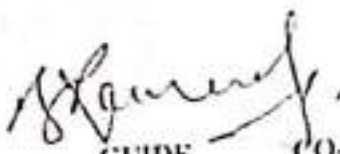

GUIDE
B. Ramana Kumar
Associate Professor

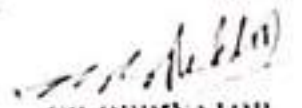
CO-ORDINATOR
Mrs. Shalk Gulnaz
Assistant Professor

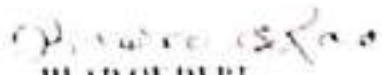
CO-ORDINATOR
Dr. V. Gunashreekar Reddy
Professor

HEAD OF DEPT.
Dr. B. Vivekvara Rao
Professor & HOD

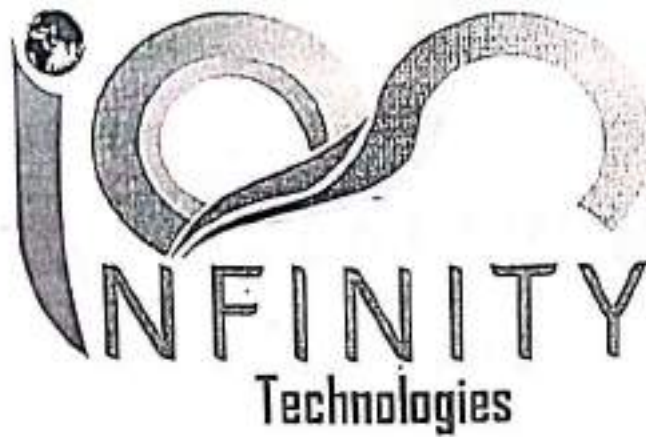
PRINCIPAL
MAHAVEER
INSTITUTE OF SCIENCE & TECHNOLOGY
Bandlaguda, Hyd-500 005.



Certificate

hereby certifies that

G.GIRIJA

has participated in Main Project Development Program at
MAHAVEER INSTITUTE OF SCIENCE & TECHNOLOGY

in ECE final year held during

02 Feb '15 - 14 Mar '15

Training Partners



ESTD : 2001

Khandy
PRINCIPAL
MAHAVEER
INSTITUTE OF SCIENCE & TECHNOLOGY
HYDERABAD

Gayatri

Course Director



Certificate

hereby certifies that

S.M.SUBBANI

has participated in Main Project Development Program at
MAHAVEER INSTITUTE OF SCIENCE & TECHNOLOGY

in ECE final year held during

02 Feb '15 - 14 Mar '15

Training Partners



ESTD : 2001

K. Subudh
PRINCIPAL
MAHAVEER
INSTITUTE OF SCIENCE & TECHNOLOGY
HYDRAABAD, ANDHRA PRADESH - 500 005.

Gayatri

Course Director



Certificate

hereby certifies that

D. GOVIND RAO

has participated in Main Project Development Program at
MAHAVEER INSTITUTE OF SCIENCE & TECHNOLOGY

in ECE final year held during

02 Feb '15 - 14 Mar '15

Training Partners



ESTD : 2001

Subh
MAHAVEER INSTITUTE OF SCIENCE & TECHNOLOGY
INSTITUTE OF SCIENCE & TECHNOLOGY
MIST

A handwritten signature in black ink, appearing to read 'Govind Rao', written over a horizontal line.

Course Director



Certificate

hereby certifies that

T.SESHADRI

has participated in Main Project Development Program at
MAHAVEER INSTITUTE OF SCIENCE & TECHNOLOGY

in ECE final year held during

02 Feb '15 - 14 Mar '15

Training Partners



ESTD : 2001

Kanishk
PRINCIPAL
MAHAVEER
INSTITUTE OF SCIENCE & TECHNOLOGY
BHEEMUNDRU, HYD-500 005.

Gayatri

Course Director



Certificate

hereby certifies that

B.SHRAVAN KUMAR

has participated in Main Project Development Program at
MAHAVEER INSTITUTE OF SCIENCE & TECHNOLOGY

in ECE final year held during

02 Feb '15 - 14 Mar '15

Training Partners



ESTD : 2001

K. Srinivas
Principal
MAHAVEER INSTITUTE OF SCIENCE & TECHNOLOGY
HYDERABAD

Gayatri

Course Director

MAHAVEER INSTITUTE OF SCIENCE AND TECHNOLOGY
(Affiliated to JNTU Hyderabad and approved by AICTE)
Vyasapuri, Bandlaguda, Post: Keshavgi,
Hyderabad- 500 005



CERTIFICATE

This is to certify that the project titled "STAIR CLIMBING ROBOT" is submitted by

K.ARAVINDA	11E31A0488
K.DINESH KUMAR	11E31A0489
M.VAISHNAVI	11E31A0490
M.N.PRANATHI	11E31A0491
MD.MAHABOOB	11E31A0492

in partial fulfillment for the award of the Degree of Bachelor of Technology in Electronics and Communication Engineering to the Jawaharlal Nehru Technological University, Hyderabad, during the year 2015 and is a bonafied project work carried out under our supervision.

The results embodied in this project work has not been submitted to any other University for the award of any degree or diploma

V. Himaja
GUIDE

Mrs.V.Himaja
Assistant Professor

Vijay
CO-ORDINATOR

Mrs. Shaik Gulnaz
Assistant Professor

Dr. V. Gunashekar Reddy
CO-ORDINATOR

Dr. V.Gunashekar Reddy
Professor

Dr. B. Visvesvara Rao
HEAD OF DEPT.

Dr. B.Visvesvara Rao
Professor & HOD



K. Sankar
PRINCIPAL
MAHAVEER
INSTITUTE OF SCIENCE & TECHNOLOGY
Bandlaguda, Hyd-500 005.



Certificate

hereby certifies that

K. DINESH KUMAR

has participated in Main Project Development Program at
MAHAVEER INSTITUTE OF SCIENCE & TECHNOLOGY

in ECE final year held during

02 Feb '15 - 14 Mar '15

Training Partners



ESTD : 2001

K. Srinivas
PRINCIPAL
MAHAVEER
INSTITUTE OF SCIENCE & TECHNOLOGY
Bandlaguda, Hyd-500 005.

G. Jayaram

Course Director



Certificate

hereby certifies that

M VAISHNAVI

has participated in Main Project Development Program at
MAHAVEER INSTITUTE OF SCIENCE & TECHNOLOGY

in ECE final year field during

02 Feb '15 - 14 Mar '15

Training Partners



ESTD : 2001

K. Srinivas

PRINCIPAL
MAHAVEER
INSTITUTE OF SCIENCE & TECHNOLOGY
Bendlaguda, Hyd-500 005.

Gayatri

Course Director



Certificate

hereby certifies that

M.N.PRANATHI

is participated in Main Project Development Program at
MAHAVEER INSTITUTE OF SCIENCE & TECHNOLOGY

in ECE final year held during

02 Feb '15 - 14 Mar '15

Training Partners



K. Sankar
PRINCIPAL
MAHAVEER
INSTITUTE OF SCIENCE & TECHNOLOGY
Bandlaguda, Hyd-500 005.

Gayatri

Course Director



Certificate

hereby certifies that

MOHAMMAD MAHABOOB

has participated in Main Project Development Program at
MAHAVEER INSTITUTE OF SCIENCE & TECHNOLOGY

in ECE final year field during

02 Feb '15 - 14 Mar '15

Training Partners



ESTD : 2001

Handwritten signature

PRINCIPAL
MAHAVEER
INSTITUTE OF SCIENCE & TECHNOLOGY
HYDRABAD, TELANGANA

Handwritten signature

Course Director

MAHAVEER INSTITUTE OF SCIENCE & TECHNOLOGY

Vyasapuri, Bandlaguda, Post: Keshavgiri, Hyderabad - 500 005



CERTIFICATE

This is to certify that main project based on 'AUTOMATIC GATE CONTROL' of the Electronics and Communication Engineering course which is being submitted by

D.SAI PRABHU RAJU	11E31A0478
DURGA PRASAD NR	11E31A0479
G.AISHWARYA	11E31A0480
G.PRANAVI	11E31A0481
G. SAI PRASAD	11E31A0482

In partial fulfillment for the award of Degree of Bachelor of Technology in Electronics and Communication Engineering to the Mahaveer Institute of Science and Technology, affiliated to Jawaharlal Nehru Technological University and is a bonafide record of work carried out by them under our supervision during the academic year 2014-2015



GUIDE

B. Ramana Kumar
Associate Professor

COORDINATOR

Mrs. Shaik Gulnaz
Assistant Professor

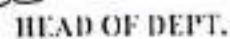

COORDINATOR

Dr. V. Gunashekar Reddy
Professor

HEAD OF DEPT.

Dr. B. Viswawara Rao
Professor & HOD

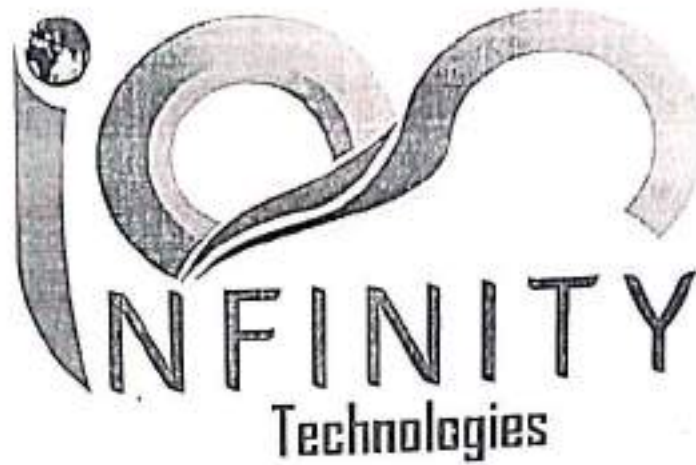
PRINCIPAL
MAHAVEER
INSTITUTE OF SCIENCE & TECHNOLOGY
Bandlaguda, Hyd-500 005.



Certificate

hereby certifies that

D.SAI PRABHU RAJU

has participated in Main Project Development Program at
MAHAVEER INSTITUTE OF SCIENCE & TECHNOLOGY

in ECE final year held during

02 Feb '15 - 14 Mar '15

Training Partners



ESTD : 2001

K. Subudh

PRINCIPAL
MAHAVEER

INSTITUTE OF SCIENCE & TECHNOLOGY
Bandlaguda, Hyd-500 005.

Ganesh

Course Director



Certificate

hereby certifies that

DURGA PRASAD NR

has participated in Main Project Development Program at
MAHAVEER INSTITUTE OF SCIENCE & TECHNOLOGY

in ECE final year held during

02 Feb '15 - 14 Mar '15

Training Partners



ESTD : 2001

K. Srinivas
MIST
MAHAVEER
INSTITUTE OF SCIENCE & TECHNOLOGY
SARAFAL, MULUNURU, HYD.

Gayatri

Course Director



Certificate

hereby certifies that

GANNAPURAM AISHWARYA

has participated in Main Project Development Program at

MAHAVEER INSTITUTE OF SCIENCE & TECHNOLOGY

in ECE final year field during

02 Feb '15 - 14 Mar '15

Training Partners



Wishu
PRINCIPAL
MAHAVEER
INSTITUTE OF SCIENCE & TECHNOLOGY
Bandlaguda, Hyd-500 005.

Gayatri

Course Director



Certificate

hereby certifies that

G.PRANAVI

has participated in Main Project Development Program at

MAHAVEER INSTITUTE OF SCIENCE & TECHNOLOGY

in ECE final year held during

02 Feb '15 - 14 Mar '15

Training Partners



ESTD : 2001

W. Subudh
PRINCIPAL
MAHAVEER
INSTITUTE OF SCIENCE & TECHNOLOGY
Bandlaguda, Hyd-500 005.

Gayatri

Course Director



Certificate

hereby certifies that

G.SAI PRASAD

has participated in Main Project Development Program at
MAHAVEER INSTITUTE OF SCIENCE & TECHNOLOGY

in ECE final year held during

02 Feb '15 - 14 Mar '15

Training Partners



ESTD : 2001

K. Sankar
PRINCIPAL
MAHAVEER
INSTITUTE OF SCIENCE & TECHNOLOGY
Warranguluda, Hyd-500 005.

G. Jayaram

Course Director

MAHAVEER INSTITUTE OF SCIENCE AND TECHNOLOGY

(Affiliated to JNTU Hyderabad, Approved by AICTE)

Vyasapuri, Bandlaguda, Post: Keshavagiri

Hyderabad -500 005



CERTIFICATE

This is to certify that the Main-Project report titled "AUTOMATIC VISITOR COUNTER" is submitted by

S.VAMSHI	11E31A04A9
SHAIK IMRAN	11E31A04B0
SUMAN BALA	11E31A04B1
T.SAI DINESH	11E31A04B3
T.THIRUPATHI REDDY	11E31A04B4

In partial fulfillment for the award of Degree of Bachelor of Technology in Electronics and Communication Engineering to the Mahaveer Institute of Science and Technology, affiliated to Jawaharlal Nehru Technological University and is a bonafide record work carried out by them under our supervision during the academic year 2014-2015.

The results embodied in this project report have not been submitted to any other University or Institute for the award of any degree or diploma.

GUIDE
Ms.D.Sonita
Asst.Professor

COORDINATOR
Mrs.Shaik Gulnaz
Asst.Professor

COORDINATOR
Dr.V.Gunashakar Reddy
Professor

HEAD OF DEPT
Dr.B.Visvesvara Rao
Professor and HOD



PRINCIPAL
MAHAVEER INSTITUTE OF SCIENCE & TECHNOLOGY
BANDLAGUDA, HYD-5



Certificate

hereby certifies that

S.VAMSHI

has participated in Main Project Development Program at
MAHAVEER INSTITUTE OF SCIENCE & TECHNOLOGY

in ECE final year held during

02 Feb '15 - 14 Mar '15

Training Partners



ESTD : 2001

Unish
PRINCIPAL
MAHAVEER
INSTITUTE OF SCIENCE & TECHNOLOGY
Bandlaguda, Hyd-500 005.

Gayatri

Course Director



Certificate

hereby certifies that

SHAIK IMRAN

has participated in Main Project Development Program at

MAHAVEER INSTITUTE OF SCIENCE & TECHNOLOGY

in ECE final year field during

02 Feb '15 - 14 Mar '15

Training Partners



ESTD : 2001

K. Srinivas
PRINCIPAL
MAHAVEER
INSTITUTE OF SCIENCE & TECHNOLOGY
Bandlaguda, Hyd-500 015.

Ganesh

Course Director



Certificate

hereby certifies that

T.SAI DINESH

as participated in Main Project Development Program at
MAHAVEER INSTITUTE OF SCIENCE & TECHNOLOGY

in ECE final year field during

02 Feb '15 - 14 Mar '15

Training Partners



ESTD : 2001

K. Sankar
PRINCIPAL
MAHAVEER
INSTITUTE OF SCIENCE & TECHNOLOGY
Bandlaguda, Hyd-500 005.

Gayatri

Course Director



Certificate

hereby certifies that

T. THIRUPATHI REDDY

has participated in Main Project Development Program at
MAHAVEER INSTITUTE OF SCIENCE & TECHNOLOGY

in ECE final year field during

02 Feb '15 - 14 Mar '15

Training Partners



ESTD : 2001



Gayatri

Course Director

MAHAVEER INSTITUTE OF SCIENCE AND TECHNOLOGY

(Affiliated to JNTU Hyderabad and approved by AICTE)

Vyasapuri, Bandlaguda, Post: Keshavgi,
Hyderabad- 500 005



CERTIFICATE

This is to certify that the project titled "RFID BASED TOLL TAX COLLECTION SYSTEM"
is submitted by

P.KAVYAPRIYA	11E31A0498
P.PRANAY SAI	11E31A04A0
P. SANTHOSH	11E31A04A1
P.SHIVA KUMAR	11E31A04A2
P.SUJITA RANI	11E31A04A3

In partial fulfilment for the award of the Degree of Bachelor of Technology in Electronics and Communication Engineering to the Mahaveer Institute of Science and Technology, affiliated to Jawaharlal Nehru Technological University and is a bonafide record of work carried out by them under our supervision during the academic year 2014-2015.

The results embodied in this project work have not been submitted to any other University for the award of any degree or diploma.

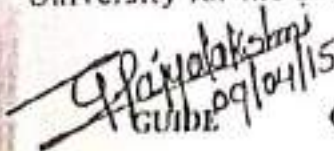
G.P. Rajyalakshmi
GUIDE
09/04/15
CO-ORDINATOR

CO-ORDINATOR

HEAD OF DEPT.

Mrs.G.Rajyalakshmi
Asst. professor

Mrs. Shaik Gulnaz
Asst. Professor

Dr. V. Gunashekar Reddy
Professor

Dr. B.Vivesvara Rao
Professor and HOD



PRINCIPAL
MAHAVEER
INSTITUTE OF SCIENCE & TECHNOLOGY
Bandlaguda, Hyd-500 005



Certificate

hereby certifies that

P.KAVYA PRIYA

has participated in Main Project Development Program at
MAHAVEER INSTITUTE OF SCIENCE & TECHNOLOGY

in ECE final year held during

02 Feb '15 - 14 Mar '15

Training Partners



ESTD : 2001

K. Srinivas
2015
MAHAVEER INSTITUTE OF SCIENCE & TECHNOLOGY
HYDRABAD
Gayatri

Course Director



Certificate

hereby certifies that

P.PRANAYSAI

has participated in Main Project Development Program at

MAHAVEER INSTITUTE OF SCIENCE & TECHNOLOGY

in ECE final year held during

02 Feb '15 - 14 Mar '15

Training Partners



ESTD : 2001

K. Subh
PRINCIPAL
MAHAVEER
INSTITUTE OF SCIENCE & TECHNOLOGY
Banjara Hills, Hyd-500 005.

Gayatri

Course Director



Certificate

hereby certifies that

P.SANTHOSH

has participated in Main Project Development Program at
MAHAVEER INSTITUTE OF SCIENCE & TECHNOLOGY

in ECE final year held during

02 Feb '15 - 14 Mar '15

Training Partners



ESTD : 2001

Handwritten signature in green ink.

Handwritten signature in black ink.

Course Director



Certificate

hereby certifies that

P.SHIVA KUMAR

has participated in Main Project Development Program at
MAHAVEER INSTITUTE OF SCIENCE & TECHNOLOGY

in ECE final year field during

02 Feb '15 - 14 Mar '15

Training Partners



ESTD : 2001

K. Srinivas

PRINCIPAL

M. MAHAVEER

INSTITUTE OF SCIENCE & TECHNOLOGY

Bandlaguda, Hyd-500 005.

Gayatri

Course Director



Certificate

hereby certifies that

P.SUJITHA RANI

has participated in Main Project Development Program at

MAHAVEER INSTITUTE OF SCIENCE & TECHNOLOGY

in ECE final year held during

02 Feb '15 - 14 Mar '15

Training Partners



ESTD : 2001

Mahaveer
PRINCIPAL
MAHAVEER
INSTITUTE OF SCIENCE & TECHNOLOGY
HYDRABAD

Gayatri

Course Director

DEPARTMENT OF AERONAUTICAL ENGINEERING

Vysapuri, Bandlaguda Post: Keshavgirl,
Hyderabad-500 005, AP INDIA
Tel: 040-20020772, 20020773, Fax: 040-24455003
E-mail: e3hod.aero1@gmail.com
Website: www.mlst.ac.in.

MAHAVEER



Approved by AICTE, Affiliated to JNTUH, Hyd

CERTIFICATE

This is to certify that this is the bonafide record of the project titled "DESIGN AND ANALYSIS OF NOZZLES" is submitted by CH. PHANEENDRA (14E31A2104), M. ANJANEYULU (14E31A2114), M. ANIL (14E31A2124), R. SWAPNA (14E31A2131), B Tech in the partial fulfillment of the requirements for the degree of Bachelor of Technology in Aeronautical Engineering, Dept. of Aeronautical Engineering during the year 2017-2018. The results embodied in this project report have not been submitted to any other university or institute for the award of any degree or diploma.

M. THIRUPATHI
Asst. professor
INTERNAL GUIDE

Prof. A. RANGA REDDY
M. Tech
HEAD OF THE DEPARTMENT

EXTERNAL EXAMINER



PRINCIPAL
MAHAVEER
INSTITUTE OF SCIENCE & TECHNOLOGY
Bandlaguda, Hyd-500 005.

2017-2018

MAHAVEER

INSTITUTE OF SCIENCE & TECHNOLOGY

Approved by AICTE, Affiliated to JNTU, Hyderabad,
Vyasaapur, Bandlaguda, Post: Keshavnagar, Hyderabad-500005.



ESTD : 2001

CERTIFICATE

This is to certify that the project entitled " **BLUETOOTH BASED AIR POLLUTION MONITORING AT ZONE LIKE SCHOOLS AND HOSPITALS**".

G.YASHWANTH	12E35A0406
S.SANTHOSH	13E31A0450
R.RAKESH	13A31A04C7
M.VAMSHI KRISHNA	14E35A0403

In partial fulfillment of the requirements for the degree of *BACHELORS OF TECHNOLOGY IN ELECTRONICS AND COMMUNICATION* of Mahaveer Institute Of Science and Technology ,Hyderabad, during the academic year 2017-2018, is a bonafide record of work carried out under our guidance and supervision.

The results embodied in this report have not been submitted to any other university institution for the award of any degree or diploma.

DEEPA GOPINATH
PROJECT GUIDE

M. DEVARAJU
ASSOCIATE PROFESSOR
PROJECT CO-ORDINATOR

DR.P. GNANASIVAM
PROFESSOR
HEAD OF THE DEPT.

EXTERNAL EXAMINER



PRINCIPAL
MAHAVEER
INSTITUTE OF SCIENCE & TECHNOLOGY
Bandlaguda, Hyd-500 005.

Certificate

This is to certify that

RAKESH. R	13E31A04C7
S. SANTOSH	13E31A0450
M. VAMSHI KRISHNA	14E35A0403
G. JASHWANTH	12E35A0406

Students of final year B.Tech, Electronics and Communication Engineering, MAHAVEER INSTITUTE OF SCIENCE AND TECHNOLOGY, HYDERABAD (affiliated to J.N.T.University, Hyderabad), have successfully completed their project titled "BLUETOOTH BASED AIR POLLUTION MONITORING ZONES LIKE SCHOOLS AND HOSPITALS" in EMBEDDED SYSTEMS, CONSCIENCE TECHNOLOGIES (CT), Hyderabad.

For CONSCIENCE TECHNOLOGIES

Project Manager

B.V.KRISHNA REDDY

PRINCIPAL
MAHAVEER
INSTITUTE OF SCIENCE & TECHNOLOGY
DILIKHONNAR, HYDERABAD

Vysapuri, Bandlaguda Post: Keshavpuri,
Hyderabad-500 005, TS, INDIA
Tel: 040-20020772, 20020773, Fax: 040-24455003
E-mail: e3hod.ecce@gmail.com,
Website: www.mist.ac.in

MAHAVEER
INSTITUTE OF SCIENCE & TECHNOLOGY
Approved by AICTE. Affiliated to JNTUH, Hyd.



CERTIFICATE

This is to certify that the project work entitled "Health Monitoring System of Specimen (Missile)" is submitted by

Mohd Azher Uddin
Sareddy Swetha
Asfia Sultana

14E31A0481
14E31A0495
14E31A0463

Handwritten signatures and initials:
A. S. Sareddy
S. Sareddy
Asfia

In partial fulfillment of the requirements for the Degree of Bachelor of Technology in Electronics and Communication Engineering of Mahaveer Institute of Science and Technology, Hyderabad, during the academic year 2017-18, is a bonafide record of work carried out under our guidance and supervision.

The results embodied in this report have not been submitted to any other university or Institution for the award of any degree or diploma.

Handwritten signature: N. Ravi Kumar
12/06/18
N. Ravi Kumar
Asst. Professor
Guide

Handwritten signature: M. Devaraju
M. Devaraju
Associate Professor
Project Co-Ordinator

Handwritten signature: Dr. P. Gnanasivam
Dr. P. Gnanasivam
Professor
Head of the Dept.



Handwritten signature:
External Examiner

PRINCIPAL
MAHAVEER
INSTITUTE OF SCIENCE & TECHNOLOGY
Bandlaguda, Hyd-500 005.

क्र.सं. S.No 92753

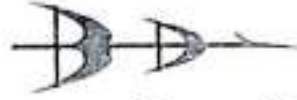

भारत डायनामिक्स लिमिटेड
BHARAT DYNAMICS LIMITED
(भारत सरकार का उद्यम A Govt. of India Enterprise)

रक्षा मंत्रालय Ministry of Defence
कंचनबाग Kanchanbagh :: हैदराबाद Hyderabad - 500058.

प्रणाली प्रौद्योगिकी तथा प्रबंधन संस्थान
INSTITUTE OF SYSTEMS, TECHNOLOGY AND MANAGEMENT

वर्ष Year 2018



Skill India
शिक्षण द्वारा - गुणवत्ता

पंजीकरण संख्या Regd. No. 377

परियोजना प्रमाण-पत्र PROJECT CERTIFICATE

सुश्री/श्री

Ms./Mr. ASFIA SULTANA

पुत्री/पुत्र श्रीमती एवं श्री

Daughter/Son of Smt. YASMEEN SULTANA श्री SYED HAMEED UDDIN

कॉलेज/संस्थान

College/Institute MAHAVEER INSTITUTE OF SCIENCE & TECH

विषय/क्षेत्र

Subject/Discipline B.TECH [ECE] वर्ष/सेमिस्टर 4-2

परियोजना कार्य/प्रशिक्षण कार्य

has completed Project Work / Training on HEALTH MONITORING
SYSTEM OF MISSILE

Duration 45 DAYS Period from 22-01-18 to 7-03-18

के बीच पूर्ण किया है.

इस कार्य के दौरान इन्होंने अध्ययन में पर्याप्त रुचि दिखाई है.

He / She has shown keen interest in learning during the period of Project.

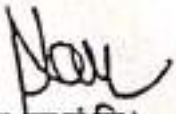
प्रमुख (मा.सं.वि.)
Head (HRD)
सय्यद रफी
SYED RAFFI

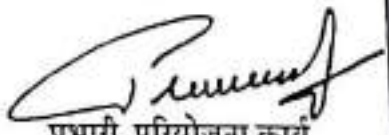

प्रभारी, परियोजना कार्य
Incharge, Project Works
वी. प्रवीण कुमार
V-PRAVEENKUMAR

सहप्रबंधक (का. एवं प्रशा.) - डी.बी.यू.
General Manager (P&A)- KBU

प्रबंधक (का. एवं प्रशा.) डिप्टी एवं प्रशि.
Manager (P&A) Appr. & Trgs.

PRINCIPAL
MAHAVEER
INSTITUTE OF SCIENCE & TECH
Bandlaguda, Hyd-500005.

क्र.सं. S No. 9275-1



भारत डायनामिक्स लिमिटेड
BHARAT DYNAMICS LIMITED
(भारत सरकार का उद्यम A Govt. of India Enterprise)

रक्षा मंत्रालय Ministry of Defence
कंचनबाग Kanchanbagh :: हैदराबाद Hyderabad -- 500058.

प्रणाली प्रौद्योगिकी तथा प्रबंधन संस्थान
INSTITUTE OF SYSTEMS, TECHNOLOGY AND MANAGEMENT



वर्ष Year 2018

पंजीकरण संख्या Regd. No. 378

Skill India
शिक्षण - गुण - रक्षा

परियोजना प्रमाण-पत्र PROJECT CERTIFICATE

सुश्री/श्री

Ms./Mr. SAREDDY SWETHA

पुत्री/पुत्र श्रीमती एवं श्री

Daughter/Son of Smt. NAGENDRA श्री VASANTH REDDY

कॉलेज/संस्थान

College/Institute MAHAVEER INSTITUTE OF SCIENCE & TECH

विषय/क्षेत्र

Subject/Discipline B.TECH [ECE]

वर्ष/सेमेस्टर

Year/Semester 4-2

परियोजना कार्य/प्रशिक्षण कार्य

has completed Project Work / Training on HEALTH MONITORING SYSTEM OF MISSILE

Duration 45 DAYS Period from 22-01-18 to 7-03-18

के बीच पूर्ण किया है.

इस कार्य के दौरान इन्होंने अध्ययन में पर्याप्त रुचि दिखाई है.

He/She has shown keen interest in learning during the period of Project.

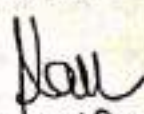
प्रमुख (मा.सं.वि.)
Head (HRD)
सच्यद रफी
SYED RAFFI





प्रभारी, परियोजना कार्य
Incharge, Project Works
श्री. प्रवीण कुमार
V. PRAVEEN KUMAR

KARINICAL
MAHAVEER
INSTITUTE OF SCIENCE & TECHNOLOGY
Bandlaguda, Hyd-500 005.

सहायक प्रमुख (सा. एवं प्रशा.) - के.बी.शु.
General Manager (P&A)- KBU

प्रमुख (मा.सं.वि.) के.बी.शु.
Manager (P&A) App. & Reg.

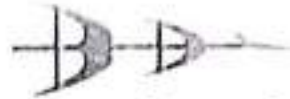
क्र.स. S No 92741



भारत डायनामिक्स लिमिटेड
BHARAT DYNAMICS LIMITED
(भारत सरकार का उद्यम A Govt. of India Enterprise)

रक्षा मंत्रालय Ministry of Defence
कंचनबाग Kanchanbagh :: हैदराबाद Hyderabad - 500058.

प्रणाली प्रौद्योगिकी तथा प्रबंधन संस्थान
INSTITUTE OF SYSTEMS, TECHNOLOGY AND MANAGEMENT

वर्ष Year 2018



Skill India
शिक्षण - कर्म - सुरक्षा

पंजीकरण संख्या Regd. No. 372

परियोजना प्रमाण-पत्र PROJECT CERTIFICATE

सुश्री/श्री

Ms./Mr. MOHD AZHER UDDIN

पुत्री/पुत्र धीमती एवं श्री

Daughter/Son of Smt. NOORJAHAN BEGUM श्री MD. HAFEEZ UDDIN

कॉलेज/संस्थान

College/Institute MAHAVEER INSTITUTE OF SCIENCE & TECH

विषय/क्षेत्र

Subject/Discipline B-TECH (ECE) वर्ष/सेमिस्टर 4-2

परियोजना कार्य/प्रशिक्षण कार्य

has completed Project Work / Training on HEALTH MONITORING
SYSTEM OF SPECIMEN (MISSILE)

Duration TWO MONTHS Period from 12-01-2018 to 11-03-2018

के बीच पूर्ण किया है.

इस कार्य के दौरान इन्होंने अध्ययन में पर्याप्त रुचि दिखाई है.

He/She has shown keen interest in learning during the period of Project.

प्रमुख (मा.सं.वि.)
Head (HRD)

खण्ड रफ़ी
-SYED RAFFE

मुहर

Seal



प्रभारी, परियोजना कार्य
Incharge, Project Works

PRINCIPAL
MAHAVEER
INSTITUTE OF SCIENCE & TECHNOLOGY
Bandlaguda, Hyd-500 085.

Vysapuri, BandlagudaPest, Keshavnagar,

Hyderabad-500 005, TS, INDIA

Tel: 040-20020772, 20020773,

Fax: 040-2445500

E-mail: eshed.ecc@gmail.com

Website: www.mist.ac.in

MAHAVEER

INSTITUTE OF SCIENCE & TECHNOLOGY

Approved by AICTE, Affiliated to JNTU, Hyd.



CERTIFICATE

This is to certify that the project work entitled **X-RAY BAGGAGE INSPECTION SYSTEM** is submitted by

P. Manumadhav	14E31A0490
Md. Amzad Pasha	14E31A0480
T.Venkata Natraj	14E31A0496
N.Mahender Yadav	14E31A0484

In partial fulfillment of the requirements for the Degree of Bachelor of Technology in *Electronics and Communication Engineering* of Mahaveer Institute of Science and Technology, Hyderabad, during academic year **2017-18**, is a bonafide record of work carried out under our guidance and supervision.

The results embodied in this report have not been submitted to any other university or Institution for the award of any degree or diploma.

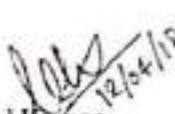
N. Ravi Kumar
Asst. Professor
Guide

M. Devaraju
Assoc. Professor
Project Incharge

Dr. P. Guhanishankar
Professor
Head of the Dept

External Examiner



PRINCIPAL
MAHAVEER
INSTITUTE OF SCIENCE & TECHNOLOGY
Bandlaguda, Hyd-500 005.

Mahaveer Institute of Science & Technology
Department of Computer Science & Engineering
IV B.Tech CSE-2014-2017 BATCH Major Projects Details

S.N e.	H.T.NO.	PROJECT NAME	GUIDE NAME	DESIGNATION
1	14E31A05B3	Inference attack on Browsing History of Twitter Users using Public click Analytics and Twitter Metadata	Mrs.J.Madhavi	ASSISTANT PROFESSOR
	14E31A0599			
	14E31A0588			
	14E31A05A4			
2	14E31A0562	Search Rank Fraud and Malware Detection in Google play	Mr.K.Giri Bahu	ASSISTANT PROFESSOR
	14E31A0591			
	14E31A05577			
	14E31A05A3			
3	14E31A0572	Rapers: A GENERIC STRATEGY FOR COLD START RATING PREDICTION PROBLEM	Mr.P.Solmon	ASSISTANT PROFESSOR
	14E31A0568			
	14E31A05B2			
4	14E31A05A1	IPATH-PATH INFERENCE IN WIRELESS SENSOR NETWORKS	Mrs.Sarajini Rani	ASSISTANT PROFESSOR
	14E31A05B1			
	14E31A05C3			
	14E31A0573			
5	14E31A0565	Securing Cloud Data Under key Exposure	Mr.B.Kishore	ASSISTANT PROFESSOR
	14E31A0566			
	14E31A0569			
6	14E31A0595	A DISTRIBUTOR PUBLISHER-DRIVEN SECURE DATA SHARING SCHEME FOR INFORMATION-CENTRIC IoT	Mr.K.Sudhakar	ASSISTANT PROFESSOR
	14E31A05A9			
	13E31A0515			
	14E31A05B7			
7	14E31A05A7	SWEET SERVING THE WEB USING EXPLOITTING EMAIL TUNNELS	Mrs.Manasa	ASSISTANT PROFESSOR
	14E31A0576			
	14E31A05B0			
	14E31A0580			
8	14E31A0590	A PROXY BASED COLLABORATION SYSTEM TO MINIMIZE CONTENT DOWNLOAD TIME AND ENERGY CONSUMPTION EXPLANATION	Mrs.RAJINI PARIMALA	ASSISTANT PROFESSOR
	14E31A0596			
	14E31A0586			
	14E31A05A0			
9	14E31A0567	NET SPAM: A NETWORK BASED SPAM DETECTION FRAMEWORK FOR REVIEWS IN ONLINE SOCIAL MEDIA	Mrs.M.Vijayalaxmi	ASSISTANT PROFESSOR
	14E31A05B5			
	14E31A0577			
	14E31A0583			
10	14E31A05B8	SOCIAL QNA: AN ONLINE SOCIAL NETWORK BASED QUESTION AND ANSWER SYSTEM	Mr.Hanzeer Ahmed	ASSISTANT PROFESSOR
	14U31A0539			
	14E31A0564			
	14E31A0589			
11	14E31A0575	COLLABORATIVE FILTERING BASED RECOMMENDATION OF ONLINE SOCIAL VOTING	Mr.B.Seru.Noik	ASSOCIATE PROFESSOR
	14E31A0563			
	14E31A05B6			
	14E31A0578			
12	14E31A05A6	ATTRIBUTE BASED STORAGE SUPPORTING SECURE DE-DUPLICATION OF ENCRYPTED DATA IN CLOUD	Dr.M.Suresh	Professor
	14E31A0574			
	14E31A0582			
	14E31A05A8			

HOD-CSE
MAHAVEER
 INSTITUTION

MAHAVEER INSTITUTE OF SCIENCE & TECHNOLOGY
(Affiliated to JNTU Hyderabad, Approved by AICTE)
Vyasapuri, Bandlaguda, Post - Keshavgiri, Hyderabad-500005



CERTIFICATE

This is to certify that the Industry Oriented Main Project work report entitled **"Detecting Stress based on Social Interactions in Social Networks"** which is being submitted by **L. Devi [14E31A0529], Neha Samreen [14E31A0538], K. Sai Sangeetha [14E31A0528]** in partial fulfilment for the award of the Degree of **BACHELOR OF TECHNOLOGY** in **COMPUTER SCIENCE AND ENGINEERING** of **JAWAHARLAL NEHRU TECHNOLOGICAL UNIVERSITY HYDERABAD**, is a record of the bonafide work carried out by them under our guidance and supervision.

Mrs. M. Sonia
Asst. Professor

Dr. M. Suresh
Head Of the Department

External Examiner

Dr. K. S. S. S. Reddy
Principal

PRINCIPAL
MAHAVEER
INSTITUTE OF SCIENCE & TECHNOLOGY
Bandlaguda, Hyd-500 005.

MAHAVEER INSTITUTE OF SCIENCE AND TECHNOLOGY

(Affiliated to JNTU Hyderabad, Approved by AICTE)
Vyasapuri, Bandlaguda, Post: Keshavgiri, Hyderabad-500005



CERTIFICATE

This is to certify that the industry oriented major project report entitled “**Re-Ranking of images based on topic diversity**” which is being submitted by **A.Pranay Reddy [14E31A0508]**, **M.A.Mujadid Mohiuddin [14E31A0530]**, **Vijay Ojha [14E31A0558]**, **Y. Raj Kumar [14E31A0560]** in partial fulfilment for the award of the Degree of **BACHELOR OF TECHNOLOGY** in **COMPUTER SCIENCE AND ENGINEERING** of **JAWAHARLAL NEHRU TECHNOLOGICAL UNIVERSITY**, is a record of the bona fide work carried out by them under our guidance and supervision.

Mr.K.Sudhakar

Project guide

DR.M.Suresh

Head of department

External Examiner

Dr. K. S. S. S.N. Reddy
Principal

PRINCIPAL
MAHAVEER
INSTITUTE OF SCIENCE & TECHNOLOGY
Bandlaguda, Hyd-500 005.

MAHAVEER INSTITUTE OF SCIENCE & TECHNOLOGY
(Affiliated to JNTU Hyderabad, Approved by AICTE)
Vyasapuri, Bandlaguda, Post: Keshavgiri, Hyderabad-500005



CERTIFICATE

This is to certify that the industry oriented major project work report entitled “**Privacy Preserving Utility Verification of Data Published by Non Interactive Differentially Private Mechanism**” Which is being submitted by Saba Samreen [14E31A0547], G.Roja Rani [14E31A0523], Akhilendra Alle [14E31A0504], Jaipal Dongre [14E31A0513] in partial fulfillment for the award of the Degree of **BACHELOR OF TECHNOLOGY** in **COMPUTER SCIENCE AND ENGINEERING** of **JAWAHARLAL NEHRU TECHNOLOGY UNIVERSITY**, is a record of the bona fide work carried out by them under our guidance and supervision.

Mrs. M. Srividya
Project guide

External Examiner

Dr. M. Suresh
Head Of The Department

PRINCIPAL
MAHAVEER
INSTITUTE OF SCIENCE & TECHNOLOGY
Bandlaguda, Hyd-500 005.

Dr. K. S. S. S. N. Reddy
Principal

MAHAVEER INSTITUTE OF SCIENCE & TECHNOLOGY

(Affiliated to JNTU Hyderabad, Approved by AICTE)

Vyasapuri, Bandlaguda, Post: Keshavgiri, Hyderabad-500005



CERTIFICATE

This is to certify that the major project report entitled "Soci Rank: Identifying and Ranking Prevalent news topics using Social Media" which is being submitted by **Ch.Aishwarya[14E31A0511]**, **K.Sankirth[14E31A05327]**, **P.Srilatha [14E31A0543]**, **V. Sai Teja [14E31A0559]** in partial fulfilment for the award of the Degree of **BACHELOR OF TECHNOLOGY** in **COMPUTER SCIENCE & ENGINEERING** of **JAWAHARLAL NEHRU TECHNOLOGICAL UNIVERSITY**, is a record of the bona fide work carried out by them under our guidance and supervision.

Mr. K. Kiran

Assist. prof, CSE Dept

Dr. M. Suresh

Head of the Department

External Examiner

Dr. K. S. S. N. Reddy
Principal

PRINCIPAL
MAHAVEER
INSTITUTE OF SCIENCE & TECHNOLOGY
Bandlaguda, Hyd-500 005.

MAHAVEER INSTITUTE OF SCIENCE & TECHNOLOGY

(Affiliated to JNTU Hyderabad, Approved by AICTE)
Vyasapuri, Bandlaguda, Post: Keshavgi, Hyderabad-500005



CERTIFICATE

This is to certify that the industry oriented major project work report entitled "Connecting Social Media To E-commerce : Cold Start Product Recommendation Using Microblogging Information" which is being submitted by A.Niharika [14E31A0503], S.Naga Nikhil [14E31A0546], Vanga Prashanth [14E31A0555] in partial fulfilment for the award of the Degree of BACHELOR OF TECHNOLOGY in COMPUTER SCIENCE AND ENGINEERING of JAWAHARLAL NEHRU TECHNOLOGICAL UNIVERSITY, is a record of the bona fide work carried out by them under our guidance and supervision.

MS.D.Anusha Reddy
Assistant Professor

Dr.M.Suresh
Head Of the Department

External Examiner

Dr. K. S. S. S. N. Reddy
Principal

PRINCIPAL
MAHAVEER
INSTITUTE OF SCIENCE & TECHNOLOGY
Bandlaguda, Hyd-500 005.

MAHAVEER INSTITUTE OF SCIENCE AND TECHNOLOGY

(Affiliated to JNTU Hyderabad, Approved by AICTE)
Vyasapuri, Bandlaguda, Post: Keshavagiri, Hyderabad-500005



CERTIFICATE

This is to certify that the industry oriented major project work report entitled "AN EFFICIENT AND FINE-GRAINED BIG-DATA ACCESS CONTROL SCHEME WITH PRIVACY PRESERVING POLICY" which is being submitted by S.Sruthi[14E31A0551] S.Yogesh [14E31A0552] T.Chandrika [14E31A0553] in partial fulfilment for the award of the Degree of BACHELOR OF TECHNOLOGY in COMPUTER SCIENCE AND ENGINEERING of JAWAHARLAL NEHRU TECHNOLOGICAL UNIVERSITY, is a record of the bonafide work carried out by them under our guidance and supervision.

Mr. E. Rajesh

Prof. Dr. M. Suresh

HEAD OF THE DEPARTMENT

External Examiner

Dr. K. S. S. S. N. REDDY
Principle

PRINCIPAL
MAHAVEER
INSTITUTE OF SCIENCE & TECHNOLOGY
Bandlaguda, Hyd-500 005.

MAHAVEER INSTITUTE OF SCIENCE AND TECHNOLOGY

(Affiliated to JNTU Hyderabad, Approved by AICTE)
Vyasapuri, Bandlaguda, Post: Keshavgi, Hyderabad-500005



CERTIFICATE

This is to certify that the industry oriented mini project work report entitled **“FILTERING OUT INFREQUENT BEHAVIOUR FROM BUSINESS PROCESS EVENT LOGS”** which is being submitted by **G.Karuna Sagar [14E31A0518], Khushbhu Dongare [14E31A0526], M. Shivajyothi [14E31A0535], P. Santosh Kumar [14E31A0542]** in partial fulfilment for the award of the Degree of **BACHELOR OF TECHNOLOGY** in **COMPUTER SCIENCE AND ENGINEERING** of **JAWAHARLAL NEHRU TECHNOLOGICAL UNIVERSITY**, is a record of the bona fide work carried out by them under our guidance and supervision.

Mrs. P. Vigneshwari

Assistant Professor

External examiner

Prof. M. SURESH

[Head of the department]

PRINCIPAL

DR. K. S. S. N. REDDY

PRINCIPAL
MAHAVEER
INSTITUTE OF SCIENCE & TECHNOLOGY
Bandlaguda, Hyd-500 005.

MAHAVEER INSTITUTE OF SCIENCE & TECHNOLOGY

(Affiliated to JNTU Hyderabad, Approved by AICTE)

Vyasapuri, Bandlaguda, Post: Keshavgiri, Hyderabad-500005



CERTIFICATE

This is to certify that the major project report entitled “**Enabling Cloud Storage Auditing With Verifiable Outsourcing of Key Updates**” which is being submitted by **Amir sohail [14E31A0505]** **Rahul Kumar [14E31A0544]**, **V.Sairam [14E31A0557]**, **Saleha Begum [14E31A0548]** in partial fulfilment for the award of the Degree of **BACHELOR OF TECHNOLOGY** in **COMPUTER SCIENCE & ENGINEERING** of **JAWAHARLAL NEHRU TECHNOLOGICAL UNIVERSITY**, is a record of the bona fide work carried out by them under our guidance and supervision.

Mrs.D.Srilatha Reddy

Assist. prof , CSE Dept

Dr .M.Suresh

Head of the Department

External Examiner

Dr. K. S. S. S. N. Reddy
Principal

PRINCIPAL
MAHAVEER
INSTITUTE OF SCIENCE & TECHNOLOGY
Bandlaguda, Hyd-500 005.

MAHAVEER INSTITUTE OF SCIENCE & TECHNOLOGY

(Affiliated to JNTU Hyderabad, Approved by AICTE)
Vyasapuri, Bandlaguda, Post: Keshavgi, Hyderabad-500005

2017-2018

MAHAVEER INSTITUTE OF SCIENCE & TECHNOLOGY

(Affiliated to JNTU Hyderabad, Approved by AICTE)
Vyasapuri, Bandlaguda, Post: Keshavgi, Hyderabad-500005



CERTIFICATE

This is to certify that the industry oriented mini project work report entitled "User Vitality Ranking and Prediction in Social Networking Services: A Dynamic Network Perspective" which is being submitted by GILLA RAJESH [14E31A0520], G SAI NISHANTH REDDY [14E31A0522], I KISHOR NAYAK [14E31A0524], G SRINIVAS [14E31A0517] in partial fulfilment for the award of the Degree of BACHELOR OF TECHNOLOGY in COMPUTER SCIENCE AND ENGINEERING of JAWAHARLAL NEHRU TECHNOLOGICAL UNIVERSITY, is a record of the bonafide work carried out by them under our guidance and supervision.

Mr. A. SHIVA KUMAR
Asst. Professor

Dr. M Suresh
Head of the Department

External Examiner

PRINCIPAL
MAHAVEER
INSTITUTE OF SCIENCE & TECHNOLOGY
Bandlaguda, Hyd-500 005.



Dr. K. S. S. S. N. REDDY
Principal

MAHAVEER INSTITUTE OF SCIENCE & TECHNOLOGY
(Affiliated to JNTU Hyderabad, Approved by AICTE)
Vyasapuri, Bandlaguda, Post: Keshavgi, Hyderabad-500005



CERTIFICATE

This is to certify that the major project report entitled “Towards Real-Time, Country-Level Location Classification of Worldwide Tweets” which is being submitted by E.Anupriya [14E31A0514] M.Nithin [14E31A0533], T.Anusha [14E31A0554], V. Sreekanth [14E31A0556] in partial fulfilment for the award of the Degree of BACHELOR OF TECHNOLOGY in COMPUTER SCIENCE & ENGINEERING of JAWAHARLAL NEHRU TECHNOLOGICAL UNIVERSITY, is a record of the bona fide work carried out by them under our guidance and supervision.

Mr. M. Sreenivas Reddy
Assist. prof, CSE Dept

Dr. M. Suresh
Head of the Department

External Examiner

Dr. K. S. S. N. Reddy
Principal

PRINCIPAL
MAHAVEER
INSTITUTE OF SCIENCE & TECHNOLOGY
Bandlaguda, Hyd-500 005.

MAHAVEER INSTITUTE OF SCIENCE & TECHNOLOGY

(Affiliated to JNTU Hyderabad, Approved by AICTE)

Vyasapuri, Bandlaguda, Post: Keshavgiri, Hyderabad-500005

2017-2018



CERTIFICATE

This is to certify that the major project work report entitled "EFFICIENT CACHE SUPPORTED PATH PLANNING ON ROADS" which is being submitted by A.V ABHISHEK [14E31A0507], G.DHRUVA MANASA [14E31A0519], Y.SAHITHI [14E31A0521], M.MANISHA [14E31A0536] in partial fulfilment for the award of the Degree of BACHELOR OF TECHNOLOGY in COMPUTER SCIENCE & ENGINEERING of JAWAHARLAL NEHRU TECHNOLOGICAL UNIVERSITY, is a record of the bonafide work carried out by them under our guidance and supervision.

Mr. T.R SRINIVAS

ASSOCIATE PROFESSOR

GUIDE

Dr. M. SURESH

HEAD OF DEPARTMENT

EXTERNAL EXAMINAR

Dr. K. S. S. N. REDDY

PRINCIPAL

**PRINCIPAL
MAHAVEER
INSTITUTE OF SCIENCE & TECHNOLOGY
Bandlaguda, Hyd-500 005.**

MAHAVEER INSTITUTE OF SCIENCE & TECHNOLOGY

(Affiliated to JNTU Hyderabad, Approved by AICTE)
Vyasapuri, Bandlaguda, Post: Keshavgi, Hyderabad-500005



CERTIFICATE

This is to certify that the industry oriented mini project work report entitled "FOLLOW BUT NO TRACK PRIVACY PRESERVED PROFILE PUBLISHING IN CYBER PHYSICAL SOCIAL SYSTEM" which is being submitted by A.VISHNU PREETH REDDY [14E31A0501], A.RASAGNYA REDDY [14E31A0502], N.PAVAN [14E31A0537], P.RAMYA [14E31A0541] in partial fulfilment for the award of the Degree of BACHELOR OF TECHNOLOGY in COMPUTER SCIENCE AND ENGINEERING of JAWAHARLAL NEHRU TECHNOLOGICAL UNIVERSITY, is a record of the bona fide work carried out by them under our guidance and supervision.

Mr. K.T.SRINIVASA RAO
Professor

External Examiner

Dr .M.SURESH
HEAD OF THE DEPARTMENT

Dr. K. S. S. S. REDDY
PRINCIPAL

PRINCIPAL
MAHAVEER
INSTITUTE OF SCIENCE & TECHNOLOGY
Bandlaguda, Hyd-500 005.

MAHAVEER INSTITUTE OF SCIENCE AND TECHNOLOGY

(Affiliated to JNTU Hyderabad, Approved by AICTE)
Vyasapuri, Bandlaguda, Post: Keshavgiri, Hyderabad-500005



CERTIFICATE

This is to certify that the industry oriented major project work report entitled “**Inference Attack on Browsing History of Twitter Users using Public Click Analytics and Twitter Metadata**” which is being submitted by **V.Kranthi Kumar [14E31A05B3]**, **P. Sai Amruth Raj [14E31A0599]**, **K.Ninusha [14E31A0585]**, **M.Sai Kiran Goud [14E31A05A4]** in partial fulfilment for the award of the Degree of **BACHELOR OF TECHNOLOGY** in **COMPUTER SCIENCE AND ENGINEERING** of **JAWAHARLAL NEHRU TECHNOLOGICAL UNIVERSITY**, is a record of the bonafide work carried out by them under our guidance and supervision.

Mrs.J.Madhavi

PROJECT GUIDE



DR.M.SURESH

HEAD OF THE DEPARTMENT

External Examiner

Dr. K. S. S. S. N. REDDY
PRINCIPAL

PRINCIPAL
MAHAVEER
INSTITUTE OF SCIENCE & TECHNOLOGY
Bandlaguda, Hyd-500 005.



MAHAVEER INSTITUTE OF SCIENCE AND TECHNOLOGY

(Affiliated to JNTU Hyderabad, Approved by AICTE)
Vyasapuri, Bandlaguda, Post: Keshavgiri, Hyderabad-500005



CERTIFICATE

This is to certify that project work report entitled "Rapere: A GENERIC STRATEGY FOR COLD-START RATING PREDICTION PROBLEM" which is being submitted by D.Vishal Reddy [14E31A0572], B.Shruthi, [14E31A0568], U. Santosh [14E31A05B2], in partial fulfilment of the requirements for the award of the Degree of BACHELOR OF TECHNOLOGY in COMPUTER SCIENCE AND ENGINEERING of JAWAHARLAL NEHRU TECHNOLOGICAL UNIVERSITY, is a record of the bonafide work carried out by them under our guidance and supervision.

Mr.P.Solmon

Project Guide

Dr.M.Suresh
Head of the Department

External Examiner

Dr. K. S. S. S.N. Reddy

PRINCIPAL
MAHAVEER
INSTITUTE OF SCIENCE & TECHNOLOGY
Bandlaguda, Hyd-500 999:

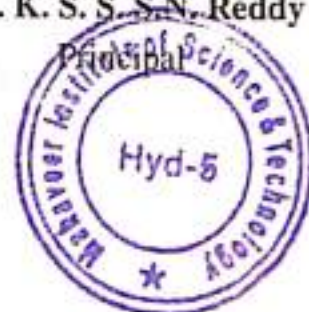

MAHAVEER INSTITUTE OF SCIENCE & TECHNOLOGY

(Affiliated to JNTU Hyderabad, Approved by AICTE)
Vyasapuri, Bandlaguda, Post: Keshavgi, Hyderabad-500005



CERTIFICATE

This is to certify that the industry oriented major project work report entitled "COLLABORATIVE FILTERING-BASED RECOMMENDATION OF ONLINE SOCIAL VOTING" which is being submitted by **A.David [14E31A0563]**, **E.Manasa [14E31A0575]**, **G.RachelChristabell [14E31A0578]**, **G.Anil Kumar [14E31A05B6]** in partial fulfilment for the award of the Degree of **BACHELOR OF TECHNOLOGY** in **COMPUTER SCIENCE AND ENGINEERING** of **JAWAHARLAL NEHRU TECHNOLOGICAL UNIVERSITY**, is a record of the bona fide work carried out by them under our guidance and supervision.

Mr.B.SevaNaik

PROJECT GUIDE

Dr.M.SURESH

HEAD OF THE DEPARTMENT

External Examiner

Dr. K. S. S. N. REDDY

PRINCIPAL
MAHAVEER
INSTITUTE OF SCIENCE & TECHNOLOGY
Bandlaguda, Hyd-500 005.



MAHAVEER INSTITUTE OF SCIENCE & TECHNOLOGY

(Affiliated to JNTU Hyderabad, Approved by AICTE)
Vyasapuri, Bandlaguda, Post: Keshavgi, Hyderabad-500005



CERTIFICATE

This is to certify that the industry oriented mini project work report entitled “Social Q&A:An online social network based question and answer system” which is being submitted by

S.DIVYA	[14E31A05B8]
A.LIKHITHA	[14E31A0564]
M.SUBHAVAN	[14UJ1A0519]
M.HARISH	[14E31A0589]

in partial fulfilment for the award of the Degree of **BACHELOR OF TECHNOLOGY** in **COMPUTER SCIENCE AND ENGINEERING** of **JAWAHARLAL NEHRU TECHNOLOGICAL UNIVERSITY**, is a record of the bonafide work carried out by them under our guidance and supervision.

Mr. MUNEER AHMED
Associate Professor

External Examiner

DR. M. SURESH
Head of the Department

Dr. K. S. S. S. N. REDDY
PRINCIPAL

PRINCIPAL
MAHAVEER
INSTITUTE OF SCIENCE & TECHNOLOGY
Bandlaguda, Hyd-500 005.



MAHAVEER INSTITUTE OF SCIENCE AND TECHNOLOGY

(Affiliated to JNTU Hyderabad, Approved by AICTE)
Vyasapuri, Bandlaguda, Post: Keshavgiri, Hyderabad-500005



CERTIFICATE

This is to certify that the project report entitled “**IPATH-PATH INFERENCE IN WIRELESS SENSOR NETWORKS**” which is being submitted by **D.Amar [14E31A0573], P.Abhishek Reddy [14E31A05A1], T.Alekya [14E31A05B1], B.Sai Krishna [13E31A05C3]** in partial fulfilment for the award of the Degree of **BACHELOR OF TECHNOLOGY in COMPUTER SCIENCE AND ENGINEERING** of **JAWAHARLAL NEHRU TECHNOLOGICAL UNIVERSITY**, is a record of the bonafide work carried out by them under our guidance and supervision.

Mrs.M.Sarojini Rani

PROJECT GUIDE

Prof. DR. M. SURESH

HEAD OF THE DEPARTMENT

External Examiner

PRINCIPAL
MAHAVEER
INSTITUTE OF SCIENCE & TECHNOLOGY
Bandlaguda, Hyd-500 005.

Dr. K. S. S. S. N. REDDY

PRINCIPAL

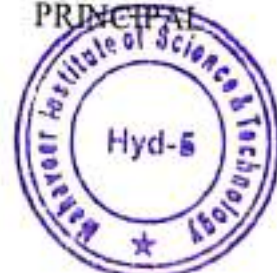

MAHAVEER INSTITUTE OF SCIENCE AND TECHNOLOGY

(Affiliated to JNTU Hyderabad, Approved by AICTE)
Vyasapuri, Bandlaguda, Post: Keshavgi, Hyderabad-500005



CERTIFICATE

This is to certify that the major project work report entitled "A PROXY BASED COLLABORATION SYSTEM TO MINIMIZE CONTENT DOWNLOAD TIME AND ENERGY CONSUMPTION EXPLANATION " which is being submitted by M.Sirilesh kumar [14E31A0590], M.P.Akhil [14E31A0596], P.Kalyan reddy [14E31A05A0], K.Bhargavi [14E31A0586] in partial fulfilment for the award of the Degree of BACHELOR OF TECHNOLOGY in COMPUTER SCIENCE AND ENGINEERING of JAWAHARLAL NEHRU TECHNOLOGICAL UNIVERSITY, is a record of the bonafide work carried out by them under our guidance and supervision.

Mrs. RAJINI PARIMALA
Project guide

Dr.M. Suresh
HEAD OF THE DEPARTMENT

PRINCIPAL
MAHAVEER
INSTITUTE OF SCIENCE & TECHNOLOGY
Bandlaguda, Hyd-500 005.

External Examiner

Dr. K. S. S. S.N. REDDY
PRINCIPAL



MAHAVEER INSTITUTE OF SCIENCE AND TECHNOLOGY

(Affiliated to JNTU Hyderabad, Approved by AICTE)
Vyasapuri, Bandlaguda, Post: Keshavgi, Hyderabad-500005



CERTIFICATE

This is to certify that the industry oriented major project work report entitled "ATTRIBUTE BASED STORAGE SUPPORTING SECURE DE-DUPLICATION OF ENCRYPTED DATA IN CLOUD" which is being submitted by S.Sirisowmya (14E31A05A6), D. Shravan Goud (14E31A0574) G. Sai Kishore (14E31A0582), S. Hari Kumar (14E31A05A8) in partial fulfilment for the award of the Degree of BACHELOR OF TECHNOLOGY in COMPUTER SCIENCE AND ENGINEERING of JAWAHARLAL NEHRU TECHNOLOGICAL UNIVERSITY, is a record of the bonafide work carried out by them under our guidance and supervision.

Dr. M. Suresh

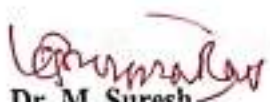
Dr. M. Suresh
HEAD OF THE DEPARTMENT

External Examiner

PRINCIPAL
MAHAVEER
INSTITUTE OF SCIENCE & TECHNOLOGY
Bandlaguda, Hyd-500 005.

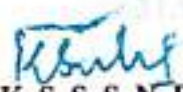
Dr. K. S. S. S. N. REDDY



MAHAVEER INSTITUTE OF SCIENCE AND TECHNOLOGY

(Affiliated to JNTU Hyderabad, Approved by AICTE)
Vyasapuri, Bandlaguda, Post: Keshavgiri, Hyderabad-500005



CERTIFICATE

This is to certify that the industry oriented major project work report entitled "Search Rank Fraud and Malware Detection in Google Play" which is being submitted by A.Anirudh Reddy [14E31A0562], M.Raghavendra [14E31A0591], N.Mounika [14E31A0577], R.Manisha [14E31A05A3] in partial fulfilment for the award of the Degree of BACHELOR OF TECHNOLOGY in COMPUTER SCIENCE AND ENGINEERING of JAWAHARLAL NEHRU TECHNOLOGICAL UNIVERSITY, is a record of the bonafide work carried out by them under our guidance and supervision.

Mr. K. Giti Babu

PROJECT GUIDE

DR. M. SURESH

HEAD OF THE DEPARTMENT

External Examiner

Dr. K. S. S. N. REDDY

PRINCIPAL

PRINCIPAL
MAHAVEER
INSTITUTE OF SCIENCE & TECHNOLOGY
Bandlaguda, Hyd-500 005.



MAHAVEER INSTITUTE OF SCIENCE AND TECHNOLOGY

(Affiliated to JNTU Hyderabad, Approved by AICTE)
Vyasapuri, Bandlaguda, Post: Keshavgiri, Hyderabad-500005



CERTIFICATE

This is to certify that the major project work report entitled "SWEET: SERVING the WEB by EXPLOITING EMAIL TUNNELS" which is being submitted by Shradha Ojha [14E31A05A7], Syeda Sadiyah Tasneem [14E31A05B0], E.Vamshidhar [14E31A0576], G.Sai Chakradhar [14E31A0580] in partial fulfilment for the award of the Degree of BACHELOR OF TECHNOLOGY in COMPUTER SCIENCE AND ENGINEERING of JAWAHARLAL NEHRU TECHNOLOGICAL UNIVERSITY, is a record of the bonafide work carried out by them under our guidance and supervision.

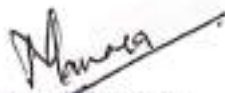
Mrs. Manasa
Project guide

Dr. M. Suresh
HEAD OF THE DEPARTMENT

External Examiner

Dr. K. S. S. S. N. REDDY

PRINCIPAL
MAHAVEER
INSTITUTE OF SCIENCE & TECHNOLOGY
Bandlaguda, Hyd-500 005.





CERTIFICATE

This is to certify that this project report entitled “A Distributed Publisher-Driven Secure Data Sharing Scheme for Information-Centric IoT” which is submitted by Munazza Fatima [14E31A0595], Syed Waseem [14E31A05A9], Shreya Mayuri [14E31A05B7], CH.Sai Vamshi Krishna [13E31A0515] in partial fulfillment for the award of Bachelor of Technology Degree in Computer Science and Engineering department of Mahaveer Institute of Science and Technology, affiliated to Jawaharlal Nehru Technological University, Hyderabad and is a bonafide record of work carried out by them under our guidance during 2017-2018.

Signature of Project Guide
Mr. K. Sudhakar

Signature of Head of Department
Dr. M. Suresh

External Examiner

Dr.K.S.S.S.N. REDDY
(Principal)

PRINCIPAL
MAHAVEER
INSTITUTE OF SCIENCE & TECHNOLOGY
Bandlaguda, Hyd-500 005..



MAHAVEER INSTITUTE OF SCIENCE & TECHNOLOGY

(Affiliated to JNTU Hyderabad, Approved by AICTE)

Vyasapuri, Bandlaguda, Post - Keshavgiri, Hyderabad-
500005



CERTIFICATE

This is to certify that the Industry Oriented Main Project work report entitled
"Securing Cloud Data Under key Exposure" which is being submitted
by **Ayesha Begum [14E31A0565], B. Rajesh [14E31A0566], B. Srikanth [14E31A0569]** in partial fulfilment for the award of the Degree of **BACHELOR OF TECHNOLOGY in COMPUTER SCIENCE AND ENGINEERING** of **JAWAHARLAL NEHRU TECHNOLOGICAL UNIVERSITY HYDERABAD**, is a record of the bonafide work carried out by them under our guidance and supervision.

Mr. B. Kishore

Asst. Professor

Dr. M. Suresh

Head Of the Department

Dr. K. S. S. S. Reddy

External Examiner

**PRINCIPAL
MAHAVEER
INSTITUTE OF SCIENCE & TECHNOLOGY
Bandlaguda, Hyd-500 005.**



MAHAVEER INSTITUTE OF SCIENCE AND TECHNOLOGY

(Affiliated to JNTU Hyderabad, Approved by AICTE)

Vyasapuri, Bandlaguda, Post: Keshavgiri, Hyderabad-500005



CERTIFICATE

This is to certify that the industry oriented mini project work report entitled "Net Spam: A Network-Based Spam Detection Framework for Reviews in Online Social Media" which is being submitted by **B.Srujan [14E31A0567]**, **Fawaz Ahmed [14E31A0577]**, **L.Sai Teja [14E31A0583]**, **Ch.Sai Teja [14E31A05B5]** in partial fulfilment for the award of the Degree of **BACHELOR OF TECHNOLOGY** in **COMPUTER SCIENCE AND ENGINEERING** of **JAWAHARLAL NEHRU TECHNOLOGICAL UNIVERSITY**, is a record of the bonafide work carried out by them under our guidance and supervision.

Mrs.M.Vijayalaxmi

PROJECT GUIDE

Prof. DR.M.SURESH

HEAD OF THE DEPARTMENT

External Examiner

Dr. K. S. S. S.N. REDDY

PRINCIPAL

PRINCIPAL
MAHAVEER
INSTITUTE OF SCIENCE & TECHNOLOGY
Bandlaguda, Hyd-500 005.



MAHAVEER INSTITUTE OF SCIENCE AND TECHNOLOGY

(Affiliated to JNTU Hyderabad, Approved by AICTE)
Vyasapuri, Bandlaguda, Post: Keshavgi, Hyderabad-500 005



CERTIFICATE

This is to certify that this project report entitled Follow Bu. No Track: Privacy Preserved Profile Publishing In Cyber Physical Social Systems which is submitted by A.Divya[14E31A1202] and B.Saikiran Reddy[14E31A1204] in partial fulfilment for the award of Bachelor of Technology Degree in Information Technology department of Mahaveer Institute of Science and Technology, affiliated to Jawaharlal Nehru Technological University, Hyderabad and is a bonafide record of work carried out by them under our guidance during 2017-2018.

Signature of Project Guide
Mr.V.Naresh Kumar Reddy

Signature of Head of Department
Dr.Ch.B.Nagalakshmi
(HOD, IT)

PRINCIPAL
MAHAVEER
INSTITUTE OF SCIENCE & TECHNOLOGY
Bandlaguda, Hyd-500 005.

PRINCIPAL
MAHAVEER
INSTITUTE OF SCIENCE & TECHNOLOGY
Bandlaguda, Hyd- 500 005

External Examiner

Dr.K.S.S.S.N. REDDY
(Principal)

MAHAVEER INSTITUTE OF SCIENCE AND TECHNOLOGY

(Affiliated to JNTU Hyderabad, Approved by AICTE)

Vyasapuri, Bandlaguda, Post: Keshavgi, Hyderabad-500 005



CERTIFICATE

This is to certify that this project report entitled "Privacy Protection and Intrusion Avoidance for Cloudlet-based Medical Data Sharing" which is submitted by B.Akshay Reddy[14E31A1205] and G.Santhosh[14E31A1209] in partial fulfillment for the award of Bachelor of Technology Degree in Information Technology department of Mahaveer Institute of Science and Technology, affiliated to Jawaharlal Nehru Technological University, Hyderabad and is a bonafide record of work carried out by them under our guidance during 2017-2018.

Signature of Project Guide

Mrs.T.Saikiran

Signature of Head of Department

**Dr.Ch.B.Nagalakshmi
(HOD, IT)**

External Examiner

PRINCIPAL
MAHAVEER
INSTITUTE OF SCIENCE & TECHNOLOGY
Bandlaguda, Hyd-500 005.



MAHAVEER INSTITUTE OF SCIENCE AND TECHNOLOGY

(Affiliated to JNTU Hyderabad, Approved by AICTE)

Vyasapuri, Bandlaguda, Post: Keshavnigri, Hyderabad-500 005



CERTIFICATE

This is to certify that this project report entitled "Connecting Social Media to E-Commerce: Cold-Start Product Recommendation using Microblogging Information" which is submitted by **D. Sravani, K.Saikiran** bearing the roll numbers 14E31A1206, 14E31A1212 in partial fulfillment for the award of degree of **Bachelor of Technology in Information Technology** to the Mahaveer Institute of Science and Technology, affiliated to **Jawaharlal Nehru Technological University, Hyderabad** and is a bonafide record of work carried out by them under our guidance during 2017-2018.

Signature of Project Guide

Mrs. K. Param Joshi

Signature of Head of Department

Dr. Ch. B. Nagalakshmi
(HOD, IT)

External Examiner

Suby
PRINCIPAL
MAHAVEER
INSTITUTE OF SCIENCE & TECHNOLOGY
Bandlaguda, Hyd-500 005.

Dr. K. S. S. N. REDDY

(Principal)



MAHAVEER INSTITUTE OF SCIENCE AND TECHNOLOGY

(Affiliated to JNTU Hyderabad, Approved by AICTE)
Vyasapuri, Bandlaguda, Post: Keshavgi, Hyderabad-500 005.



CERTIFICATE

This is to certify that this project report entitled "Search Rank Fraud And Malware Detection In Google Play" which is submitted by G. Anusha [14E31A1208] and N. Shiva Venkata Sai[14E31A1220] in partial fulfillment for the award of Bachelor of Technology Degree in Information Technology department of Mahaveer Institute of Science and Technology, affiliated to Jawaharlal Nehru Technological University, Hyderabad and is a bonafide record of work carried out by them under our guidance during 2017-2018.

Signature of Project Guide

Mr.S. Srinivas

Signature of Head of Department

Dr.Ch.B.Nagalakshmi
(HOD, IT)

External Examiner

PRINCIPAL
MAHAVEER

INSTITUTE OF SCIENCE & TECHNOLOGY
Bandlaguda, Hyd-500 005.

Dr.K.S.S.S.N. REDDY

(Principal)

PRINCIPAL

MAHAVEER

INSTITUTE OF SCIENCE & TECHNOLOGY
Bandlaguda, Hyd- 500 005

MAHAVEER INSTITUTE OF SCIENCE AND TECHNOLOGY

(Affiliated to JNTU Hyderabad, Approved by AICTE)

Vyasapuri, Bandlaguda, Post: Keshavgi, Hyderabad-500 005



CERTIFICATE

This is to certify that this project report entitled "A Network Based Spam Detection Framework for Reviews in Online Social Media" which is submitted by G.SaiAkhil [14E31A1210] and K.Lalani [14E31A1211], in partial fulfillment for the award of Bachelor of Technology Degree in Information Technology department of Mahaveer Institute of Science and Technology, affiliated to Jawaharlal Nehru Technological University, Hyderabad and is a bonafide record of work carried out by them under our guidance during 2017-2018.

Signature of Project Guide

Mr.B.Mallaiah

Signature of Head of Department

**Dr.Ch.B.Nagala'shmi
(HOD, IT)**

External Examiner

**PRINCIPAL
MAHAVEER
INSTITUTE OF SCIENCE & TECHNOLOGY
Bandlaguda, Hyd-500 005.**

**Dr.K.S.S.S.N. REDDY
(Principal)
PRINCIPAL
MAHAVEER
INSTITUTE OF SCIENCE & TECHNOLOGY
Bandlaguda, Hyd-500 005**

MAHAVEER INSTITUTE OF SCIENCE AND TECHNOLOGY

(Affiliated to JNTU Hyderabad, Approved by AICTE)

Vyasapuri, Bandlaguda, Post: Keshavgiri, Hyderabad-500 005



CERTIFICATE

This is to certify that this project report entitled "Attribute based storage supporting Secure Deduplication of Encrypted Data in Cloud" which is submitted by **N.Vinay Reddy[14E31A1218]** and **M.Nounika Reddy[14E31A1216]** in partial fulfillment for the award of **Bachelor of Technology Degree in INFORMATION TECHNOLOGY** department of **Mahaveer Institute of Science and Technology**, affiliated to **Jawaharlal Nehru Technological University, Hyderabad** is a bonafide record of work carried out by them under our guidance during 2017-2018.

6/4/18
Signature of Project Guide

Ms. E.Sushma

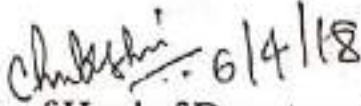
6/4/18
Signature of Head of Department

Dr.Ch.B.Nagalakshmi

(HOD,IT)

External Examiner

Dr.K.S.S.S.N. REDDY
(Principal)
PRINCIPAL
MAHAVEER
INSTITUTE OF SCIENCE & TECHNOLOGY
Bandlaguda, Hyd-500 005

MAHAVEER INSTITUTE OF SCIENCE AND TECHNOLOGY

(Affiliated to JNTU Hyderabad, Approved by AICTE)
Vyasapuri, Bandlaguda, Post: Keshavgi, Hyderabad-500 005



CERTIFICATE

This is to certify that this project report entitled "Data Lineage In Malicious Environment" which is submitted by PRANATHI.PADAKANTI [14E31A1221] and RAMA RAKESH [14E31A1222] in partial fulfillment for the award of Bachelor of Technology Degree in Information Technology department of Mahaveer Institute of Science and Technology, affiliated to Jawaharlal Nehru Technological University, Hyderabad and is a bonafide record of work carried out by them under our guidance during 2017-2018.

Signature of Project Guide
Mrs.K.B.V.K.NagaSree

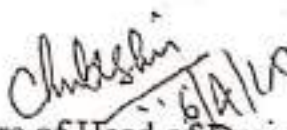
Signature of Head of Department
Dr.Ch.B.Nagalakshmi,
(HOD, I.T)

External Examiner

PRINCIPAL
MAHAVEER
INSTITUTE OF SCIENCE & TECHNOLOGY
Bandlaguda, Hyd-500 005.

Dr.K.S.S.S.N. REDDY
(Principal)

MAHAVEER INSTITUTE OF SCIENCE AND TECHNOLOGY

(Affiliated to JNTU Hyderabad, Approved by AICTE)
Vyasapuri, Bandlaguda, Post: Keshavgi, Hyderabad-500 005



CERTIFICATE

This is to certify that this project report entitled "Dual-Server Public-Key Encryption With Keyword Search for Secure Cloud Storage" which is submitted by K.DILIP[14E31A1214] and R.KAVYA REDDY[14E31A1223] in partial fulfillment for the award of Bachelor of Technology Degree in INFORMATION TECHNOLOGY department of Mahaveer Institute of Science and Technology, affiliated to Jawaharlal Nehru Technological University, Hyderabad is a bonafide record of work carried out by them under our guidance during 2017-2018.

Signature of Project Guide
Mr.A.NandaGopal Reddy

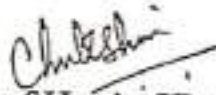
Signature of Head of Department
Dr.Ch.B.Nagalakshmi
(HOD,IT)

External Examiner

PRINCIPAL
MAHAVEER INSTITUTE OF SCIENCE & TECHNOLOGY
Bandlaguda, hya-500 005.

Dr.K.S.S.N. REDDY
(Principal)

MAHAVEER INSTITUTE OF SCIENCE AND TECHNOLOGY .
(Affiliated to JNTU Hyderabad, Approved by AICTE) Vyasapuri,
Bandlaguda, Post: Keshavgi, Hyderabad-500 005



CERTIFICATE

This is to certify that this project report entitled "A Distributed Publisher-driven Secure Data Sharing Scheme for Information-Centric IoT" which is submitted by Mahender Singh [14E31A1215] and Srujana Sreeramineni [14E31A1224] in partial fulfillment for the award of Bachelor of Technology degree in Information Technology department of Mahaveer Institute of Science and Technology, affiliated to Jawaharlal Nehru Technological University, Hyderabad and is a bonafide record of work carried out by them under our guidance during 2017-2018.

Sahithi
Signature of Project Guide
Mrs.G.Sahithi

Ch.B. Nagalakshmi
6/4/18
Signature of Head of Department
Dr.Ch.B.Nagalakshmi
(HOD, IT)

K.S.S.N. Reddy
External Examiner

K.S.S.N. Reddy
PRINCIPAL
MAHAVEER
INSTITUTE OF SCIENCE & TECHNOLOGY
Bandlaguda, Hyd-500 005.

Dr.K.S.S.S.N. REDDY
(Principal)

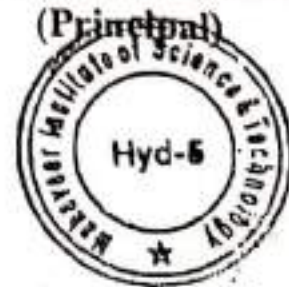

MAHAVEER INSTITUTE OF SCIENCE AND TECHNOLOGY
(Affiliated to JNTU Hyderabad, Approved by AICTE)
Vyasapuri, Bandlaguda, Post: Keshavgi, Hyderabad-500 005



CERTIFICATE

This is to certify that this project report entitled "Identity Based Proxy Oriented Data Uploading and Remote Data Integrity Checking in Public Cloud" which is submitted by V. Manasa Reddy bearing the roll number 14E31A1227 in partial fulfillment for the award of degree of Bachelor of Technology in Information Technology to the Mahaveer Institute of Science and Technology, affiliated to Jawaharlal Nehru Technological University, Hyderabad and is a bonafide record of work carried out by his under our guidance, during 2017-2018.

Signature of Project Guide

Dr.Ch.B.Nagalakshmi

Signature of Head of Department

Dr.Ch.B.Nagalakshmi

(HOD, IT)

External Examiner

MAHAVEER
INSTITUTE OF SCIENCE & TECHNOLOGY
Bandlaguda, Hyd-500 005.

Dr.K.S.S.S.N. REDDY

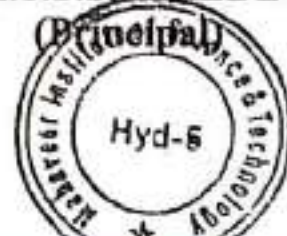

MAHAVEER INSTITUTE OF SCIENCE AND TECHNOLOGY

DEPARTMENT OF AERONAUTICAL ENGINEERING

IV-II (2017-2018) MAIN PROJECT DETAILS

S.NO	BATCH	ROLL NO	NAME OF THE STUDENT	TITTLE OF THE PROJECT	INTERNAL GUIDE
1	1	14E31A2117	MD ADNAN	ARTICULATATION AND ANALYSIS OF SPAN ADAPTIVE WING USING WIND TUNNEL	N MAMESH
2		14E31A2113	MALIK NOUMAN		
3		14E31A2133	SAQLAIN MEDHI ALI KHAN		
4		14E31A2135	SUMMIAYA FATHIMA		
5	2	14E31A2105	CH PREETHI RECHAL	FATIGUE ANALYSIS OF FUSELAGE AND WING JOINT	Y RAGHUVVEER
6		14E31A2120	MD JAFFER		
7		14E31A2101	ABDUL AZIZ		
8		14E31A2138	V KIRAN BABU		
9	3	14E31A2110	I ARCHITHA	DESIGN AND FABRICATION OF SKY SEEKAR	M SRAVANI
10		14E31A2112	K NITHI KUMAR		
11		14E31A2130	R SURYA PRAKASH		
12		14E31A2118	MD FAIYAZ		
13	4	14E31A2121	MD MAJID ALI INSHAAL	DESIGN AND ANALYSIS OF TRANSONIC WIND TUNNEL VARIABLE EFFUSER SECTION	M THIRUPATHI
14		14E31A2116	MD ALTAMASH		
15		14E31A2126	M SOLMAN		
16	5	14E31A2134	SOHAIL AHMED	DESIGN AND ANALYSIS OF AIRFRAME OF ANTI RADIATION MISSLE	V MALLESH
17		14E31A2119	MD ABDUL QADEER		
18		14E31A2120	MAUK YASER		
19	6	14E31A2137	T HARITHA	DESIGN OF CONTROLLER FOR AIRBONE VEHICLE CONTROL SYSTEM	M SRAVANI
20	7	14E31A2106	CH VISHAL	COMPUTATIONAL STUDIES OF SLANTED NOZZLES	D NAVEEN
21		14E31A2109	G RAKESH		
22		14E31A2111	K RAHUL		
23		14E31A2132	S BHARATH KUMAR		
24	8	14E31A2104	CH PHANEENDRA	DESIGN AND ANALYSIS OF NOZZLE	Y RAGHUVVEER
25		14E31A2124	M ANIL		
26		14E31A2114	M ANJAYENULU		
27		14E31A2131	R SWAPNA		

K. Srinivas

S. Damodharan
HOD

DEPARTMENT OF AERONAUTICAL ENGINEERING

Mapur, Bandlaguda Post: Keshavpur,
Serabadi-500 005, AP INDIA
: 040-20020772, 20020773, Fax: 040-24465003
mail: e3hod.aero1@gmail.com
website: www.mist.ac.in,

MAHAVEER

INSTITUTE OF SCIENCE & TECHNOLOGY

Approved by AICTE, Affiliated to JNTUH,Hyd.



CERTIFICATE

This is to certify that this is the bonafide record of the project titled "FATIGUE ANALYSIS OF FUSELAGE AND WING JOINT" is submitted by ABDUL AZIZ, CH. PREETHI RACHEL, V. KIRAN BABU, MOHD JAFFER Bearing Roll No 14E31A2101/05/38 & 12WJ1A2120 of B. Tech in the partial fulfillment of the requirements for the degree of Bachelor of Technology in Aeronautical Engineering, Dept. of Aeronautical Engineering during the year 2017-2018. The results embodied in this project report have not been submitted to any other university or institute for the award of any degree or diploma.

Y. RAGHUVVER
Assistant professor
INTERNAL GUIDE

Prof. A. RANGA REDDY
M. Tech
HEAD OF THE DEPARTMENT

EXTERNAL EXAMINER



Handwritten signature
PRINCIPAL
MAHAVEER
INSTITUTE OF SCIENCE & TECHNOLOGY
Bandlaguda, Hyd-500 005

DEPARTMENT OF AERONAUTICAL ENGINEERING

Wangalpur, Bandlaguda Post: Keshavpur,
Wangal-500 005, AP INDIA
Phone: 040-20020772, 20020773, Fax: 040-24455003
Email: e3hod.aero1@gmail.com
Website: www.mist.ac.in,

MAHAVEER

INSTITUTE OF SCIENCE & TECHNOLOGY
Approved by AICTE, Affiliated to JNTUH, Hyd.



CERTIFICATE

This is to certify that this is the bonafide record of the project titled "ARTICULATION AND ANALYSIS OF SPAN ADAPTIVE WING USING WIND TUNNEL" is submitted by MALIK NOUMAN, MOHAMMAD ADNAN, SAQLAIN KHAN, SUMMAIYA FATIMA, Bearing Roll No 14E31A2113, 14E31A2117, 14E31A2133, 14E31A2135 of B. Tech in the partial fulfillment of the requirements for the degree of Bachelor of Technology in Aeronautical Engineering, Dept. of Aeronautical Engineering during the year 2017-2018. The results embodied in this project report have not been submitted to any other university or institute for the award of any degree or diploma.

N MAHESH
Assistant professor
INTERNAL GUIDE

Prof. A. RANGA REDDY
HEAD OF THE DEPARTMENT

EXTERNAL EXAMINER

PRINCIPAL
MAHAVEER
INSTITUTE OF SCIENCE & TECHNOLOGY
WANGALPUR, WANGAL-500 005



DEPARTMENT OF AERONAUTICAL ENGINEERING

Vysapuri, Bandlaguda, Post Keshavagiri,
Hyderabad - 500 005, TS INDIA
Tel. 040-20020772, 20020773,
Website: www.mist.ac.in

MAHAVEER
INSTITUTE OF SCIENCE & TECHNOLOGY
Approved by AICTE, Affiliated to JNTU, Hyderabad.



CERTIFICATE

This is to certify that this is the bonafide record of the project titled "DESIGN AND ANALYSIS OF AIR FRAME OF ANTI RADIATION MISSILE" is submitted by MOHAMMED ABDUL QADEER, MOHD ABDUL MALIK YASER and SOHAIL AHMED Bearing Roll No.s 14E31A2119, 14E31A2120 and 14E31A2134 Of B.Tech in the partial fulfillment of the requirements for the degree of Bachelor of Technology in Aeronautical Engineering, Dept. of Aeronautical Engineering during the year 2017-2018. The results embodied in this project report have not been submitted to any other University or Institute for the award of any degree.

Mrs. M.SRAVANI
Assistant Professor
INTERNAL GUIDE

Prof. A.RANGA REDDY
HEAD OF THE DEPARTMENT

EXTERNAL EXAMINER



PRINCIPAL
MAHAVEER
INSTITUTE OF SCIENCE & TECHNOLOGY
www.mist.ac.in

DEPARTMENT OF AERONAUTICAL ENGINEERING

Vysapuri, Bandlaguda Post:Koshavglri,
Hyderabad-500 006, AP INDIA
Tel: 040-20020772, 20020773, Fax: 040-24455003
E-mail: e3hod.aero1@gmail.com
Website: www.mist.ac.in,

MAHAVEER

INSTITUTE OF SCIENCE & TECHNOLOGY
Approved by AICTE, Affiliated to JNTUH,Hyd.



CERTIFICATE

This is to certify that this is the bonafide record of the project titled "DESIGN AND ANALYSIS OF TRANSONIC WIND TUNNEL VARIABLE EFFUSER SECTION" is submitted by MOHD ALTAMASH NIZAMI AL SABAH, MOHD MAJID ALI INSHAAL AND M.SALOMON Bearing Roll No 14E31A2116/21/26 of B.Tech in the partial fulfillment of the requirements for the degree of Bachelor of Technology in Aeronautical Engineering, Dept. of Aeronautical Engineering during the year 2017-2018. The results embodied in this project report have not been submitted to any other university or institute for the award of any degree or diploma.

Y.RAGHUVIER
Assistant professor
INTERNAL GUIDE

PROF. A. RANGA REDDY
HEAD OF THE DEPARTMENT

EXTERNAL EXAMINER





DEPARTMENT OF AERONAUTICAL ENGINEERING

Vysapuri, Bandlaguda, Post Keshavagiri,

Hyderabad – 500 005, TS INDIA

Tel: 040-20020772, 20020773,

Website: www.mist.ac.in

MAHAVEER

INSTITUTE OF SCIENCE & TECHNOLOGY

Approved by AICTE, Affiliated to JNTU, Hyderabad.



CERTIFICATE

This is to certify that this is the bonafide record of the project titled "DESIGN OF CONTROLLER FOR AIRBORNE VEHICLE CONTROL SYSTEM " is submitted by Ms. T HARITHA (14E31A2137) of B.Tech in the partial fulfillment of the requirements for the degree of Bachelor of Technology in Aeronautical Engineering, Dept. of Aeronautical Engineering during the year 2017-2018. The results embodied in this project report have not been submitted to any other University or Institute for the award of any degree.

M. Sravani
M SRAVANI

Assistant Professor

INTERNAL GUIDE

A. Aranga Reddy
Prof. A.RANGA REDDY

HEAD OF THE DEPARTMENT

[Signature]

EXTERNAL EXAMINER

K. Srinivas

PRINCIPAL
KANAYGER
INSTITUTE OF SCIENCE & TECHNOLOGY
Bandlaguda, Hyderabad



DEPARTMENT OF AERONAUTICAL ENGINEERING

Vysapuri, Bandlaguda, Post Keshavagiri,
Hyderabad – 500 005, TS INDIA
Tel: 040-20020772, 20020773,
Website: www.mist.ac.in

MAHAVEER

INSTITUTE OF SCIENCE & TECHNOLOGY

Approved by AICTE, Affiliated to JNTU, Hyderabad.



CERTIFICATE

This is to certify that this is the bonafide record of the project titled "COMPUTATIONAL STUDIES OF SLANTED NOZZLES" is submitted by Mr.CHOPPALA VISHAL(14E31A2106), Mr.GUVVALA RAKESH(14E31A2109), Mr.KESHABOINA RAHUL(14E31A2111), Mr.SANTHOJU BHARAT KUMAR (14E31A2132) of B.Tech in the partial fulfillment of the requirements for the degree of Bachelor of Technology in Aeronautical Engineering, Dept. of Aeronautical Engineering during the year 2017-2018. The results embodied in this project report have not been submitted to any other University or Institute for the award of any degree.

B.NAVEEN

Assistant Professor

INTERNAL GUIDE

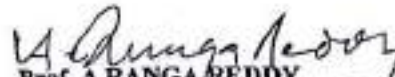
Prof. A.RANGAREDDY

HEAD OF THE DEPARTMENT

EXTERNAL EXAMINER





DEPARTMENT OF AERONAUTICAL ENGINEERING

Vysapuri, Bandlaguda, Post: Keshavagiri,
Hyderabad - 500 005, TS INDIA
Tel: 040-20020772, 20020773,
Website: www.mist.ac.in

MAHAVEER
INSTITUTE OF SCIENCE & TECHNOLOGY
Approved by AICTE, Affiliated to JNTU, Hyderabad.



CERTIFICATE

This is to certify that this is the bonafied record of the project titled "DESIGN AND FABRICATION OF SKY SEEKER" is submitted by Ms INDROJU ARCHITHA bearing roll no. 14E31A2110, Mr KISARI NITHIN KUMAR bearing roll no. 14E31A2112, Mr MOHAMMAD FAIYAZ bearing roll no. 14E31A2118, Mr SURYA PRAKASH bearing roll no. 14E31A2130 of B.Tech in the partial fulfillment of the requirements for the degree of Bachelor of Technology in Aeronautical Engineering, Dept. of Aeronautical Engineering during the year 2017-2018. The results embodied in this technical report have not been submitted to any other University or Institute for the award of any degree.

Mrs. M SRAVANI
Assistant Professor
INTERNAL GUIDE

Prof. A.RANGA REDDY
HEAD OF THE DEPARTMENT

EXTERNAL GUIDE

K. Srinivas
PRINCIPAL
MAHAVEER
INSTITUTE OF SCIENCE & TECHNOLOGY
Bandlaguda, Hyderabad





CERTIFICATION

This is to certify that the project titled "**PORTFOLIO MANAGEMENT**" submitted in partial fulfillment for the award of **MASTER OF BUSINESS ADMINISTRATION** by A.SWETHA Roll No: 16E31E0003 to the **Department of Management Studies, Mahaveer Institute of Science and Technology**, affiliated to JNTU, Hyderabad, has been carried out under the guidance of Mr.CH.RAGHUNATH REDDY Assist professor, Department of Management Studies, MIST.

This Project report has not been submitted to any other University of Institution for the award of any Degree/Diploma.

(Mr.CH. RAGHUNATH REDDY)

INTERNAL GUIDE

(DR. K. KIRAN KUMAR)

HEAD OF THE DEPARTMENT

MAHAVEER
INSTITUTE OF SCIENCE & TECHNOLOGY
Bandlaguda, Hyd-500 005

SIGNATURE OF EXTERNAL EXAMINAR





CERTIFICATION

This is to certify that the project titled "COMMODITY MARKET" submitted in partial fulfillment for the award of **MASTER OF BUSINESS ADMINISTRATION** by ANNEM RAJASEKHAR REDDY Roll No: 16E31E0004 to the **Department of Management Studies, Mahaveer Institute of Science and Technology**, affiliated to JNTU, Hyderabad, has been carried out under the guidance of **Dr.K.KIRAN KUMAR**, Head of the Department, Department of Management Studies, MIST.

This Project report has not been submitted to any other University of Institution for the award of any Degree/Diploma.

(Dr.K.KIRAN KUMAR)

INTERNAL GUIDE

(Dr.K.KIRAN KUMAR)

HEAD OF THE DEPARTMENT

K. K. Kiran Kumar

PRINCIPAL
MAHAVEER

INSTITUTE OF SCIENCE & TECHNOLOGY
Bandlaguda, Hydr-500 005.

SIGNATURE OF EXTERNAL EXAMINAR



CERTIFICATE

This is to certify that the project titled "INVESTMENT ALTERNATIVES IN INDIA at KARVY STOCK BROKING LIMITED" submitted in partial fulfillment for the award of **MASTER OF BUSINESS ADMINISTRATION** by **JULAKANTI SAIDIREDDY** Roll No: **16E31E0012** to the Department of Management Studies, **MAHAVEER INSTITUTE OF SCIENCE AND TECHNOLOGY**, Affiliated to JNTU, Hyderabad, has been carried out under the guidance of **CH. RAGHUNATH REDDY**, Asst. Professor, Department of Management Studies, MIST.

This Project report has not been submitted to any other University or Institution for the award of any Degree/Diploma.

(CH. Raghunath Reddy)

INTERNAL GUIDE

(Dr. K. Kiran Kumar)

HEAD OF THE DEPARTMENT

PRINCIPAL
MAHAVEER
INSTITUTE OF SCIENCE & TECHNOLOGY
Bandlaguda, Hyd-500 005.

EXTERNAL EXAMINAR





CERTIFICATION

This is to certify that the project titled "WORKING CAPITAL" submitted in partial fulfillment for the award of **MASTER OF BUSINESS ADMINISTRATION** by K NAVYA Roll no. 16E31E0013 to the **Department of Management Studies, Mahaveer Institute of Science and Technology**, affiliated to JNTU, Hyderabad, has been carried out under the guidance of Miss. Fouzia Shareef Assist. Professor, Department of Management Studies, MIST.

This Project report has not been submitted to any other University of Institution for the award of any Degree/Diploma.

(Miss. FOUZIA SHAREEF)

INTERNAL GUIDE

(DR. K. KIRAN KUMAR)

HEAD OF DEPARTMENT

PRINCIPAL
MAHAVEER

INSTITUTE OF SCIENCE & TECHNOLOGY
BANDLAGUDA, HYDERABAD - 500 005

SIGNATURE OF EXTERNAL EXAMINER



CERTIFICATION

This is to certify that the project titled "PARAMETRIC ANALYSIS OF MUTUAL FUNDS" submitted in partial fulfillment for the award of **MASTER OF BUSINESS ADMINISTRATION** by NEHA SINGH Roll No: 16E31E0024 to the **Department of Management Studies, Mahaveer Institute of Science and Technology**, affiliated to JNTU, Hyderabad, has been carried out under the guidance of Ms.FOUZIA SHAREEF Assist professor, Department of Management Studies, MIST.

This Project report has not been submitted to any other University of Institution for the award of any Degree/Diploma.

(Ms.FOUZIA SHAREEF)

INTERNAL GUIDE

(Dr.K.KIRAN KUMAR)

HEAD OF THE DEPARTMENT

PRINCIPAL
MAHAVEER
INSTITUTE OF SCIENCE & TECHNOLOGY
BANDLAGUDA, HYDERABAD - 500 005

SIGNATURE OF EXTERNAL EXAMINAR





CERTIFICATION

This is to certify that the project titled **"DIVIDEND ANALYSIS"** submitted in partial fulfillment for the award of **MASTER OF BUSINESS ADMINISTRATION** by **T.KEERTHI** Roll no. **16E31E0030** to the **Department of Management Studies, Mahaveer Institute of Science and Technology**, affiliated to JNTU, Hyderabad, has been carried out under the guidance of **MR.CH RAGHUNATH REDDY** Assist. Professor, Department of Management Studies, MIST.

This Project report has not been submitted to any other University of Institution for the award of any Degree/Diploma.

(MR.CH RAGHUNATH REDDY)

INTERNAL GUIDE

(DR. K.KIRAN KUMAR)

HEAD OF DEPARTMENT

SIGNATURE OF EXTERNAL EXAMINER

PRINCIPAL
MAHAVEER
INSTITUTE OF SCIENCE & TECHNOLOGY
HYDERABAD - 500 005.





CERTIFICATION

This is to certify that the project titled **“EMPLOYEE RELATIONS”** submitted in partial fulfillment for the award of **MASTER OF BUSINESS ADMINISTRATION** by **V.A. KALYANI** Roll no. 16E31E0031 to the **Department of Management Studies, Mahaveer Institute of Science and Technology**, affiliated to JNTU, Hyderabad, has been carried out under the guidance of **MRS. K S ARCHANA** Assist. Professor, Department of Management Studies, MIST.

This Project report has not been submitted to any other University of Institution for the award of any Degree/Diploma.

Archana

(MRS. K S ARCHANA)

INTERNAL GUIDE

K. Kiran Kumar

**PRINCIPAL
MAHAVEER
INSTITUTE OF SCIENCE & TECHNOLOGY
Bandlaguda, Hyd-500 005.**

(DR. K. KIRAN KUMAR)

HEAD OF DEPARTMENT

SIGNATURE OF EXTERNAL EXAMINER

MAHAVEER INSTITUTE OF SCIENCE AND TECHNOLOGY

(Affiliated to JNTUH, Hyderabad and Approved by AICTE, New Delhi)
Vyasapuri, Bandlaguda, Post: Keshavagiri, Hyderabad- 500 005

DEPARTMENT OF ELECTRICAL AND ELECTRONICS
ENGINEERING



CERTIFICATE

This is to certify that the project report with title "IoT POWERED AUTOMATION SYSTEM USING OPEN SOURCE FRAME WORK" which is being submitted by K.ANVESH SAMEER (16E31D6401) in the partial fulfilment for the award of Master of Technology Degree with specialization in POWER ENGINEERING AND ENERGY SYSTEMS in ELECTRICAL AND ELECTRONICS ENGINEERING Department of Mahaveer Institute of Science and Technology, affiliated to Jawaharlal Nehru Technological University Hyderabad.

The results embodied in this thesis have not been submitted to any other university for the award of any degree

Project Guide
G.PREM KUMAR REDDY
Associate professor
Dept. of EEE, MIST

PRINCIPAL
MAHAVEER
INSTITUTE OF SCIENCE & TECHNOLOGY
Bandlaguda, Hyd-500 005.

Head of the department
Dr. SATHYANARAYANA
Professor
Dept. of EEE, MIST

MAHAVEER INSTITUTE OF SCIENCE AND TECHNOLOGY

(Affiliated to JNTUH, Hyderabad and Approved by AICTE, New Delhi) Vasapur,
Bandlaguda, Post. Keshavagiri, Hyderabad - 500 005

DEPARTMENT OF ELECTRICAL AND ELECTRONICS ENGINEERING



ESTD 2001

CERTIFICATE

This is to certify that the project report with title 'AUTOMATIC SPEED CONTROL OF VEHICLES WITH WARNING MESSEGES AT ZONES' which is being submitted by M ARJUN (16E31D6402) in the partial fulfillment for the award of Master of Technology Degree with specialization in POWER ENGINEERING AND ENERGY SYSTEMS in Electrical and Electronics Engineering Department of Mahaveer Institute of Science and Technology, affiliated to Jawaharlal Nehru Technological University Hyderabad.

The results embodied in this thesis have not been submitted to any other university for the award of any degree

R. Kalyani

Project Guide

R. KALYANI

Assistant professor

Dept. of EEE, MIST

Kalyani
Principal
MAHAVEER INSTITUTE OF SCIENCE & TECHNOLOGY
Bandlaguda, Hyd-500 005.

S. Sathyanarayana

Head of the Department

Dr. SATHYANARAYANA

Professor

Dept. of EEE, MIST

MAHAVEER INSTITUTE OF SCIENCE AND TECHNOLOGY

(Affiliated to JNTU H, Hyderabad and Approved by AICTE, New Delhi) Vyasapuri,
Bandlaguda, Post: Keshavagiri, Hyderabad- 500005

DEPARTMENT OF ELECTRICAL AND ELECTRONICS ENGINEERING



ESTD 2001

CERTIFICATE

This is to certify that the project report with title "IOT BASED SMART IRRIGATION SYSTEM" which is being submitted by P JAYASREE (16EED6404) in the partial fulfillment for the award of Master of Technology Degree with specialization in POWER ENGINEERING AND ENERGY SYSTEMS in Electrical and Electronics Engineering Department of Mahaveer Institute of Science and Technology, affiliated to Jawaharlal Nehru Technological University Hyderabad.

The results embodied in this thesis have not been submitted to any other university for the award of any degree

A. Mahesh Kumar
8/11/2020
Project Guide

A.MAHESH KUMAR
Assistant professor
Dept. of EEE, MIST.

Kishore

PRINCIPAL
MAHAVEER
INSTITUTE OF SCIENCE & TECHNOLOGY
Bandlaguda, Hyd-500 005.

P.V.V. Sathyanarayana
10/01/2020
Head of the Department
P.V.V. SATHYANARAYANA
H.O.D & Professor
Dept. of EEE, MIST.

[Signature]
INTERNAL USE



MAHAVEER INSTITUTE OF SCIENCE & TECHNOLOGY

(An ISO 9001:2008 Certified Institution)

Vyasapuri, Bandlaguda, Post:Keshavgiri, Hyderabad-500 005, AP INDIA

Tel: 040-24455001,002,004, Fax: 040-24455003

E-mail: principal.mahaveer@gmail.com Website: www.mist.ac.in

Hyderabad,
12/07/2017

To,
The Director,
CANTER CAD Technologies Pvt. Ltd,
Hyderabad.

Sub: Recommending the Students for doing IV year B.Tech Internship in You Esteemed Organization

Respected Sir,

Mahaveer Institute of Science and Technology, a self financed institution located at Bandlaguda near DRDL, was established in the year 2001 and is offering different courses B.Tech & M.Tech with the specialization in CSE, ECE, EEE, IT, CIVIL, AERO& MECHANICAL and other pg courses MBA& MCA

Our IV year B.Tech (CIVIL) student are required to do the internship in your Esteemed Organization

Hence it is requested to give permission to give permission to do her internship in your organization. Your cooperation in this regard will be highly appreciated. The details of the student are given below:

STUDENT NAME:	ROLL NO
MOHAMMED NADEEMUDDIN	(15E35AO108)
AREF ABDUR RAHMAN AL KASERI	(14E31AO105)
MOHD MOHIUDDIN FAIZ	(14E31AO137)
MOHD ABDUL AROOF	(14E31AO134)

Thanking You,



Kashy
PRINCIPAL
MAHAVEER
INSTITUTE OF SCIENCE & TECHNOLOGY
Bandlaguda, Hyd-500 005.



CANTER CAD Technologies Pvt. Ltd
Block 'A' - 4th Floor, Eastwar Tower, above More
Supermarket, IS Sedat 'X' Road, Santrushnagar,
Hyderabad - 500 059
Ph. + 91 40 65573333,
Cell 91 89782 71111
Website : www.cantercadd.com



TO WHOM IT MAY CONCERN

This is to certify that MOHAMMED NADEEMUDDIN (15E35AO108) AREF ABDUR RAHMAN AL KASERI (14E31AO105) MOHD MOHIUDDIN FAIZ(14E31AO137) MOHD ABDUL RAOOF(14E31AO134) Students of B.Tech mini project in CIVIL ENGINEERING at Mahaveer Institute Of Science And Technology has done their project April 2017 to June 2017 for as an in term at CANTER CAD TECHNOLOGIES to accomplish their project "DESIGN AND ANALYSIS OF MULTISTOREY BUILDING BY USING E TABS" Design and implementation

During the period of the internship with us they were found punctual , hardworking and inquisitive



Corporate Office: J80 Sri Venkateswara Co-Operative Housing Society, Road No 12, Banjara Hills 7 Hyderabad-34 A P India
Phone +91 80 4009 3566 E-mail: info@cantercadd.com, www@cantercadd.com, can@cantercadd.com

Branch 5

Vijayawada

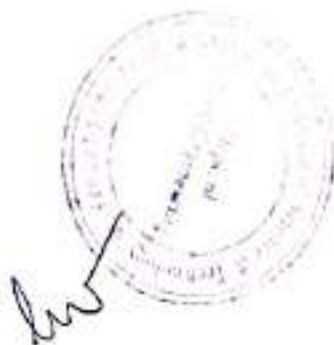

K. Srinivas
PRINCIPAL
MAHAVEER
INSTITUTE OF SCIENCE & TECHNOLOGY
Lundraguda, Hyd-500 005.



భారత్ హెవీ ఎలక్ట్రికల్స్ లిమిటెడ్
హావి పవర్ ఎలక్ట్రికల్స్ ప్లాంట్, రామచంద్రాపురం, హైదరాబాద్ - 502032 (భారత్)
भारत हेवी इलेक्ट्रिकल्स लिमिटेड
हेवी पावर इलेक्ट्रिकल प्लांट, रामचन्द्रपुरम, हैदराबाद - 502 032 (भारत)
BHARAT HEAVY ELECTRICALS LIMITED
Heavy Power Equipment Plant, Ramachandrapuram, Hyderabad - 502032 (INDIA)



మానవ వనరుల వికాస కేంద్రము / मानव संसाधन विकास केंद्र
Human Resources Development Centre

पंजीयन संख्या / Reg No BHEL2017ENG062019

दिनांक / Date 13-06-17

परियोजना कार्य प्रशिक्षण प्रमाण पत्र
PROJECT WORK TRAINING CERTIFICATE

प्रमाणित किया जाता है कि श्री/ सुश्री श्रीमति This is to certify that Mr. / Ms. / Mrs. T. Greshma Choudhary
अनुक्रमांक / Roll No 14E31A0822 ने of Mahaveer Institute of Science & Technology
महाविद्यालय / विश्वविद्यालय / college / university से अध्ययन करते हुए pursuing B.Tech
EEE पाठ्यक्रम में / Course परियोजना कार्य / इंटरनशिप प्रशिक्षण has satisfactorily completed
the Project Work / Internship Training from दिनांक Di 29-05-17 से 10 दिनांक Di 19-06-17 तक
सफलतापूर्वक पूर्ण किया है। परियोजना कार्य का शीर्षक / The title of the project is _____
Study of Turbo Alternator



ISO 9002



Accredited by the
Quality Council for
Certification

Kishu
PRINCIPAL
MAHAVEER
INSTITUTE OF SCIENCE & TECHNOLOGY
Bandlaguda, Hyd-500 005.

T. Greshma Choudhary
13.06.17

परियोजना प्रशिक्षण प्रभारी
Project Training In-Charge

राज्य कार्यालय - "बीएचईएल हाउस", सिटी फोर्ट, नई दिल्ली - 110 049
Regd. Office: "BHEL House", Sixt Fort, New Delhi - 110 049
Website: www.bhel.com

भारत हेवी इलेक्ट्रिकल्स लिमिटेड

एच पी ई एल इलेक्ट्रिकल्स प्लांट, रामचन्द्रपुरम, हैदराबाद - 502032 (भारत)

भारत हेवी इलेक्ट्रिकल्स लिमिटेड

हेवी पावर इक्विपमेंट प्लांट, रामचन्द्रपुरम, हैदराबाद - 502032 (भारत)

BHARAT HEAVY ELECTRICALS LIMITED

Heavy Power Equipment Plant, Ramachandrapuram, Hyderabad - 502032 (INDIA)

मानव संसाधन विकास केंद्र / मानव संसाधन विकास केंद्र
Human Resources Development Centre



पंजीयन संख्या / Reg No. BHEL3017ENG/09/099

दिनांक / Date 13-06-17

परियोजना कार्य प्रशिक्षण प्रमाण पत्र

PROJECT WORK TRAINING CERTIFICATE

प्रमाणित किया जाता है कि श्री/ सुश्री/ श्रीमति This is to certify that Mr. / Ms. / Mrs. L. Surech Kumar

अनुक्रमांक / Roll No. 14031A0213 ने of Mahaveer Institute of Science & Technology

महाविद्यालय / विश्वविद्यालय / college / university से अध्ययन करते हुए pursuing B.Tech

EEE पाठ्यक्रम में / Course परियोजना कार्य / इंटरशिप प्रशिक्षण has satisfactorily completed

the Project Work / Internship Training from दिनांक Dt. 09-05-17 से to दिनांक Dt. 12-06-17 तक

सफलतापूर्वक पूर्ण किया है। परियोजना कार्य का शीर्षक / The title of the project is _____

Study of Turbo Alternator



ISO 9002



Accredited by the
Dutch Council for
Certification

Mahaveer
MAHAVEER
INSTITUTE OF SCIENCE & TECHNOLOGY
Bandlaguda, Hyd-500 005.

Manik
13-06-17

परियोजना प्रशिक्षण प्रभारी
Project Training In-Charge

Telangana State Power Generation Corporation Ltd.

(A Govt. of TS undertaking)

Kakatiya Thermal Power Project, Chelpur – 506170,

Jayashankar Bhupalpally - Dist



CERTIFICATE

This is to certify that MIR ABDUL KAREEM KHAN - 14E31A0216 is a bonafide student of Bachelor of Technology in ELECTRICAL AND ELECTRONICS ENGINEERING, MAHAVEER INSTITUTE OF SCIENCE AND TECHNOLOGY - HYDERABAD.

He has carried out the mini project entitled on "STUDY OF KAKATIYA THERMAL POWER PROJECT" successfully under the esteemed guidance of E.RAMA KRISHNA (AE/EM/CHP), A.SUNIL(ADE/EM/CHP) and J.CHANDAN SINGH(DE/EM/CHP) at Kakatiya Thermal Power Project.

E.RAMA KRISHNA
AE/EM/CHP/KTPP
Asst. ENGINEER
Electrical Sub-division
CHP / O&M / KTPP

A.SUNIL
ADE/EM/CHP/KTPP
Asst. DIVISIONAL ENGINEER
Electrical Sub-division,
CHP / O&M / KTPP

J.CHANDAN SINGH
DE/EM/CHP/KTPP
Divisional Engineer
EM/CHP/KTPP
CHELPUR

PRINCIPAL

MAHAVEER
INSTITUTE OF SCIENCE & TECHNOLOGY
Bandlaguda, Hyd-500 005.

CERTIFICATE

This is to certify that the project entitled "SWITCHYARD AND OPERATIONAL ASPECTS" On It - N.T.P.C Ramagundam has been successfully carried out, in the partial fulfillment for the award of "Bachelor Of Technology In Electrical And Electronics Engineering" from

KADA SAINATH

(14E35A0202)



MAHAVEER INSTITUTE OF SCIENCE & TECHNOLOGY, BANDLAGUDA
HYDERABAD - 500005

This bonafide work has been carried out by Students of MAHAVEER INSTITUTE OF SCIENCE & TECHNOLOGY, BANDLAGUDA carried out, project work under our guidance and supervision at "National Thermal Power Corporation Limited - Ramagundam", during the academic year 2013-2017.

PROJECT GUIDE
मुख्य संयोजक
प्रबंधक Mansoor
एनटीपीसी-रामगुंडम
ज्योतिनगर 2013-2017

PROJECT CO - ORDINATOR
जी. भास्कर G. BASKAR
उप महाप्रबंधक Dy. General Manager (O&M)
एनटीपीसी लिमिटेड NTPC Limited, Ramagundam
ज्योतिनगर JYOTHINAGAR - 505 215
LDBX : 5839, Cell : 9440901763

PRINCIPAL

MAHAVEER
INSTITUTE OF SCIENCE & TECHNOLOGY
Bandlaguda, Hyd 500 044



To
The Head of the Department,
Electronics & Communication Engineering
Mahaveer Institute of Science & Technology,
Vyasa Puri, Chandrayangutta,
Hyderabad, Telangana 500005.

INTERNSHIP CERTIFICATE

TO WHOMSOEVER IT MAY CONCERN

This is to certify that **Mr. Poralla Bharath Kumar**, Roll Number – **(14E31A0489)**, who is pursuing **Electronics and Communication Engineering**, Department at **Mahaveer Institute of Science & Technology** successfully completed his Internship program at **Conscience Technologies** on **Intelligent Traffic Control using Embedded System** and **has submitted the report.**

During the Internship program period, the candidate has shown keen interest and commitment towards learning and his performance was good.

Duration: 08/05/2017 to 10/07/2017

Yours truly,

(Project Manager)



Conscience Technologies

Khanji
PRINCIPAL
MAHAVEER
INSTITUTE OF SCIENCE & TECHNOLOGY
Bondlaiguda, Hyd-500 005.



To
The Head of the Department,
Electronics & Communication Engineering
Mahaveer Institute of Science & Technology,
Vyasa Puri, Chandrayangutta,
Hyderabad, Telangana 500005.

INTERNSHIP CERTIFICATE
TO WHOMSOEVER IT MAY CONCERN

This is to certify that Ms. G.Amrutha, Roll Number - (14E31A0415), who is pursuing **Electronics and Communication Engineering**, Department at **Mahaveer Institute of Science & Technology** successfully completed her Internship program at **Conscience Technologies** on **RFID based Vehicle access control system** and has submitted the report.

During the Internship program period, the candidate has shown keen interest and commitment towards learning and her performance was good.

Duration:

Yours truly,

(Project Manager)



K. Srinivas
PRINCIPAL
MAHAVEER
INSTITUTE OF SCIENCE & TECHNOLOGY
Bandlaguda, Hyd-500 005.

Certificate

This is to certify that

AREKATLA DIVYA

14E31A1202

B.SAI KIRAN REDDY

14E31A1204

Students of final year B.Tech, **Information Technology**,
MAHAVEER INSTITUTE OF SCIENCE AND TECHNOLOGY,
HYDERABAD (affiliated to J.N.T.University, Hyderabad), have successfully
completed their project titled "**FOLLOW BUT NO TRACK: PRIVACY
PRESERVED PROFILE PUBLISHING IN CYBER PHYSICAL
SOCIAL SYSTEMS**" in JAVA DIVISION, **CONSCIENCE TECHNOLOGIES
(CT), Hyderabad.**

For **CONSCIENCE TECHNOLOGIES**



K. Srinivas
PRINCIPAL
MAHAVEER
INSTITUTE OF SCIENCE & TECHNOLOGY
Bandlaguda, Hyd-500 005.



Certificate

This is to certify that

BANDHYALA AKSHAY REDDY

14E31A1205

GANTE SANTHOSH

14E31A1209

Students of final year B.Tech, **Information Technology**,
MAHAVEER INSTITUTE OF SCIENCE AND TECHNOLOGY,
HYDERABAD (*affiliated to J.N.T.University, Hyderabad*), have successfully
completed their project titled "**PRIVACY PROTECTION AND INTRUSION
AVOIDANCE FOR CLOUDLET-BASED MEDICAL DATA
SHARING**" in **JAVA DIVISION, CONSCIENCE TECHNOLOGIES (CT)**,
Hyderabad.

For **CONSCIENCE TECHNOLOGIES**

Project Manager

BVKreddy
B.V.KRISHNA REDDY

Kshiraj

PRINCIPAL

MAHAVEER

INSTITUTE OF SCIENCE & TECHNOLOGY

Bandlaguda, Hyd-500 005.

Certificate

This is to certify that

DEVARANENI SRAVANI

14E31A1206

KARSIKA SAIKIRAN

14E31A1212

Students of final year B.Tech, Information Technology, MAHAVEER INSTITUTE OF SCIENCE AND TECHNOLOGY, HYDERABAD (*affiliated to J.N.T.University, Hyderabad*), have successfully completed their project titled "CONNECTING SOCIAL MEDIA TO E-COMMERCE: COLD-START PRODUCT RECOMMENDATION USING MICROBLOGGING INFORMATION" in JAVA DIVISION, CONSCIENCE TECHNOLOGIES (CT), Hyderabad.

For CONSCIENCE TECHNOLOGIES

Project Manager

B.V. Krishna Reddy
B.V. KRISHNA REDDY

K. Mahaveer
PRINCIPAL
MAHAVEER
INSTITUTE OF SCIENCE & TECHNOLOGY
Bandlaguda, Hyd-500 005.



Certificate

This is to certify that

GANGIDI ANUSHA

14E31A1208

NARAGONI SHIVA VENKATA SAI

14E31A1220

Students of final year B.Tech, **Information Technology,**
MAHAVEER INSTITUTE OF SCIENCE AND TECHNOLOGY,
HYDERABAD (affiliated to J.N.T.University, Hyderabad), have successfully
completed their project titled "SEARCH RANK FRAUD AND MALWARE
DETECTION IN GOOGLE PLAY" in JAVA DIVISION, CONSCIENCE
TECHNOLOGIES (CT), Hyderabad.

For CONSCIENCE TECHNOLOGIES

Project Manager

BVKreddy
B.V.KRISHNA REDDY



K. Srinivas
PRINCIPAL
MAHAVEER
INSTITUTE OF SCIENCE & TECHNOLOGY
Bandlaguda, Hyd-500 005.

Address

#17-83/2C, 3rd Floor, Opp. Bank of Maharashtra,
Annapurna Function Hall Line,
Dilsukhnagar, Hyderabad-500060.

Certificate

This is to certify that

GUJJA SAI AKHIL

14E31A1210

KAVETI LALANI

14E31A1211

Students of final year B.Tech, **Information Technology**,
MAHAVEER INSTITUTE OF SCIENCE AND TECHNOLOGY,
HYDERABAD (*affiliated to J.N.T.University, Hyderabad*), have successfully
completed their project titled "**NETSPAM: A NETWORK BASED SPAM
DETECTION FRAMEWORK FOR REVIEW IN ONLINE SOCIAL
MEDIA**" in **JAVA DIVISION**, **CONSCIENCE TECHNOLOGIES (CT)**,
Hyderabad.

For **CONSCIENCE TECHNOLOGIES**

Project Manager

B.V. KRISHNA REDDY

PRINCIPAL
MAHAVEER
INSTITUTE OF SCIENCE & TECHNOLOGY
Bandlaguda, Hyd-500 005.

Certificate

This is to certify that

MAMIDIPALLY MOUNIKA

14E31A1216

NALIMELA VINAY REDDY

14E31A1218

Students of final year B.Tech, Information Technology, MAHAVEER INSTITUTE OF SCIENCE AND TECHNOLOGY, HYDERABAD (affiliated to J.N.T.University, Hyderabad), have successfully completed their project titled "ATTRIBUTE-BASED STORAGE SUPPORTING SECURE DEDUPLICATION OF ENCRYPTED DATA IN CLOUD" in JAVA DIVISION, CONSCIENCE TECHNOLOGIES (CT), Hyderabad.

For CONSCIENCE TECHNOLOGIES

Project Manager

B.V.K.Reddy

B.V.KRISHNA REDDY

Kishu
PRINCIPAL
MAHAVEER
INSTITUTE OF SCIENCE & TECHNOLOGY
Bandlaguda, Hyd-500 005.

Certificate

This is to certify that

RAMA RAKESH

14E31A1222

PRANATHI PADAKANTI

14E31A1221

Students of final year B.Tech, **Information Technology**,
MAHAVEER INSTITUTE OF SCIENCE AND TECHNOLOGY,
HYDERABAD (*affiliated to J.N.T.University, Hyderabad*), have successfully
completed their project titled "**DATA LINEAGE IN MALICIOUS
ENVIRONMENT**" in **JAVA DIVISION, CONSCIENCE TECHNOLOGIES
(CT), Hyderabad.**

For **CONSCIENCE TECHNOLOGIES**

Project Manager

B.V.Kr Reddy
B.V.KRISHNA REDDY

K. Srinivas
**PRINCIPAL
MAHAVEER
INSTITUTE OF SCIENCE & TECHNOLOGY
Bandlaguda, Hyd-500 005.**



Certificate

This is to certify that

KURNAMONI DILIP

14E31A121

RAMIDI KAVYA

14E31A122

Students of final year B.Tech, **Information Technology**,
MAHAVEER INSTITUTE OF SCIENCE AND TECHNOLOGY,
HYDERABAD (*affiliated to J.N.T.University, Hyderabad*), have successfully
completed their project titled "**DUAL SERVER PUBLIC KEY
ENCRYPTION WITH KEYWORD SEARCH FOR SECURE CLOUD
STORAGE**" in **JAVA DIVISION**, **CONSCIENCE TECHNOLOGIES (CT)**,
Hyderabad.

For **CONSCIENCE TECHNOLOGIES**

Project Manager

BVKreddy
B.V.KRISHNA REDDY

K. Mahaveer
PRINCIPAL
MAHAVEER
INSTITUTE OF SCIENCE & TECHNOLOGY
Bandlaguda, Hyd-500 005.

Address

117-83/2C, 3rd Floor, Opp. Bank of Maharashtra,
Ammapuram Junction, Main Road.

Certificate

This is to certify that

MAHENDER SINGH

14E31A1215

SREERAMINENI SRUJANA

14E31A1224

Students of final year B.Tech, Information Technology, MAHAVEER INSTITUTE OF SCIENCE AND TECHNOLOGY, HYDERABAD (affiliated to J.N.T.University, Hyderabad), have successfully completed their project titled "A DISTRIBUTED PUBLISHER DRIVEN SECURE DATA SHARING SCHEME FOR INFORMATION-CENTRIC IOT" in JAVA DIVISION, CONSCIENCE TECHNOLOGIES (CT), Hyderabad.

For CONSCIENCE TECHNOLOGIES

Project Manager

B.V.Krishna Reddy
B.V.KRISHNA REDDY

K. Srinivas
PRINCIPAL
MAHAVEER
INSTITUTE OF SCIENCE & TECHNOLOGY
Bandlaguda, Hyd-500 005.

Certificate

This is to certify that

THIPPARAPU SRIVANI	14E31A1225
VEERAMREDDY MANASA	14E31A1227

Students of final year B.Tech, Information Technology, MAHAVEER INSTITUTE OF SCIENCE AND TECHNOLOGY, HYDERABAD (affiliated to J.N.T.University, Hyderabad), have successfully completed their project titled "IDENTITY BASED PROXY ORIENTED DATA UPLOADING AND DATA INTEGRITY CHECKING IN THE PUBLIC CLOUD" in JAVA DIVISION, CONSCIENCE TECHNOLOGIES (PVT), Hyderabad.

for CONSCIENCE TECHNOLOGIES

Project Manager
V.Krishna Reddy
V.KRISHNA REDDY

K. Mahaveer
PRINCIPAL
MAHAVEER
 INSTITUTE OF SCIENCE & TECHNOLOGY
 Bandlaguda, Hyd-500 005.

Vysapuri, Bandlaguda Post:Keshavgiri,
Hyderabad-500 005, Telangana INDIA
Tel: 040-64596979,20020773, Fax: 040-24455003
E-mail: principal.mahaveer@gmail.com,
Website: www.mist.ac.in,

MAHAVEER

INSTITUTE OF SCIENCE & TECHNOLOGY
Approved by AICTE, Affiliated to JNTUH,Hyd.



DEPARTMENT OF CIVIL ENGINEERING

PROPOSAL LETTER

Hyderabad,

16/08/2017.

To,
The principal,
MIST,
Hyderabad.

Sub: Proposal for three weeks workshop on ETABS-Reg.

Dear Sir,

We are working as asst professor in the department of CIVIL ENGINEERING. Sir, we are going to conduct three weeks workshop on ETABS. We require your approval to go head for further proceeding and hope to get an opportunity to serve you the best .

With thanks and Regards



K. Srinivas
PRINCIPAL
MAHAVEER
INSTITUTE OF SCIENCE & TECHNOLOGY
Bandlaguda, Hyderabad.

From,
Civil Department
Mist,
Bandlaguda,

Vysapuri, Bandlaguda Post:Keshavgirl,
Hyderabad-500 005, Telangana INDIA
Tel: 040-64596979,20020773, Fax: 040-24455003
E-mail: principal.mahaveer@gmail.com,
Website: www.mist.ac.in,

MAHAVEER
INSTITUTE OF SCIENCE & TECHNOLOGY
Approved by AICTE, Affiliated to JNTUH,Hyd.



DEPARTMENT OF CIVIL ENGINEERING
CIRCULAR

Hyderabad.

Date: 22.08.2017

Technical Training for III B. Tech students are starting from 22 -08- 2017 onwards. All HODs and Placements coordinators have to manage the trainings and ensure 95% attendance all through the sessions.

All Mentors need to send the compiled feedback report to Ch.Swethamber, HOD at e3hod.civil@gmail.com daily.

Agenda: 1. Introduction to ETABS.

CHLSWETHAMBER

HOD



Designed by : M.VASANTHALAXMI
B RAJASEKHAR

Kesha
PRINCIPAL
MAHAVEER
INSTITUTE OF SCIENCE & TECHNOLOGY
Bandlaguda, Hyd 500 005.



DEPARTMENT OF CIVIL ENGINEERING

ETABS SYLLABUS

- 1: The knowledge about specialized software such as ETABS, SAFE to model and analyze for buildings.
- 2: Be able to model, analyze, and solve structural models on Specialized software and access analysis results such as force, Displacement and another parameter for structural design.
- 3: Be able to communicate and work in the group flexibly and Efficiently.
- 4: Explaining concepts, terminology and rules used in ETABS, SAFE software.
- 5: Modeling and analyzing type of simple and complex structural Systems.
- 6: Analyzing and determining the values of internal forces, Displacements and other parameters for structural design.
- 7: Working in the group to solve the problems relates to using Software ETABS, SAFE.
- 8: Choosing appreciable communication skills such as speech, Text, images, graphics, when expressing personal views.



K. Srinivas
PRINCIPAL
MAHAVEER
INSTITUTE OF SCIENCE & TECHNOLOGY
Bandlaguda, Hyderabad - 500 005.

Vysapuri, Bandlaguda Post:Keshavgi,
Hyderabad-500 005, Telangana INDIA
Tel: 040-64596979,20020773,,Fax: 040-24455003
E-mail: principal.mahaveer@gmail.com,
Website: www.mist.ac.in,

MAHAVEER

INSTITUTE OF SCIENCE & TECHNOLOGY
Approved by AICTE, Affiliated to JNTUH,Hyd.



DEPARTMENT OF CIVIL ENGINEERING
ETABS Technical Training student Marks list 2017-18

S.No	Hall Ticket No	Name of the Candidate
1	15E31A0101	A DIVISHA
2	15E31A0103	BAGUROTHUSAIUJWALA
3	15E31A0108	CHANDAVENKATESH
4	15E31A0109	DHADIVIJAY
5	15E31A0111	ELISHETTY TEJASWINI
6	15E31A0112	ERUKULLASRIKANTH
7	15E31A0115	GOPIPRANAY
8	15E31A0117	LOKASANISURENDERREDDY
9	15E31A0118	M AVINASHI
10	15E31A0119	MADIRENARESH
11	15E31A0120	MD ABDULMUNAM
12	15E31A0121	MD SALMAN CHOUDHARY
13	15E31A0122	MOHAMMED ETHESHAM



K. Srinivas

PRINCIPAL
MAHAVEER
INSTITUTE OF SCIENCE & TECHNOLOGY
Bandlaguda, Hyderabad-500 005.

Vysapuri, Bandlaguda Post:Keshavgiri,
Hyderabad-500 005, Telangana INDIA
Tel: 040-64596979,20020773, Fax: 040-24455003
E-mail: principal.mahaveer@gmail.com,
Website: www.mist.ac.in,

MAHAVEER

INSTITUTE OF SCIENCE & TECHNOLOGY

Approved by AICTE, Affiliated to JNTUH,Hyd.



14	15E31A0123	MOHDAHMED
15	15E31A0124	MUBARAK ALDAYANI
16	15E31A0125	NENAVATH SANTHOSH
17	15E31A0130	PITTALA RAJESH KUMAR
18	15E31A0131	SABIRALIE
19	15E31A0133	SHEELAM PRAMOD KUMAR
20	15E31A0134	SIDDINICHANDU
21	15E31A0140	VADLASHIRAVAN KUMAR
22	15E31A0142	ZEESHAN ASHIRAF
23	15E31A0143	M A KHADERANSARI
24	15E31A0144	PALAJUSRICHAITHANYA
25	15E31A0145	GOLLAVISHINUYADAV
26	16E35A0101	GADDAM CHARAN
27	16E35A0102	GUNDALAMANISHI
28	16E35A0103	JANAPATIRAVI
29	16E35A0104	M PRASHANTH
30	16E35A0105	M. RANJITHA
31	16E35A0107	P.PRAVALIKA
32	16E35A0108	POGAKUKEERTHIMADHURI



Keshav
PRINCIPAL
MAHAVEER
INSTITUTE OF SCIENCE & TECHNOLOGY
Bandlaguda, Hyderabad

Vysapuri, Bandlaguda Post:Keshavgi,
Hyderabad-500 005, Telangana INDIA
Tel: 040-64596979,20020773, Fax: 040-24455003
E-mail: principal.mahaveer@gmail.com,
Website: www.mist.ac.in,

MAHAVEER

INSTITUTE OF SCIENCE & TECHNOLOGY
Approved by AICTE, Affiliated to JNTUH,Hyd.



33	16E35A0109	REDAPAKA MAHESHWARI
34	14E31A0102	ABDURRAHEEMMUNAWWAR
35	14E31A0133	MOHAMMED ABDULALIFUZAIL



K. Srinivas

PRINCIPAL
MAHAVEER
INSTITUTE OF SCIENCE & TECHNOLOGY
Bandlaguda, Hyderabad-500005.

MAHAVEER INSTITUTE OF SCIENCE & TECHNOLOGY, HYDERABAD

CIVIL ENGINEERING STUDENTS ATTENDANCE

B.TECH III YEAR I SEM 2017-2018 BATCH (Date : 22-08-2017 to 01-09-2017)

S.No	Hall Ticket No	Name of the Candidate	1	2	3	4	5	6	7	8	9	10
1	15E31A0101	A DIVISHA	P	P	A	P	P	P	P	P	A	P
2	15E31A0103	BAGUROTHU SAIJWALA	A	P	P	P	A	P	P	P	P	P
3	15E31A0108	CHANDA VENKATESH	P	P	P	A	P	A	P	P	P	P
4	15E31A0109	DHADI VIJAY	P	P	P	P	A	P	P	P	P	A
5	15E31A0111	ELISHETTY TEJASWINI	A	P	P	P	P	A	P	P	A	P
6	15E31A0112	ERUKULLA SRIKANTH	P	A	P	P	A	P	P	P	P	P
7	15E31A0115	GOPI PRANAY	P	P	P	P	P	A	P	A	P	P
8	15E31A0117	LOKASANI SURENDER REDDY	P	A	A	P	P	P	P	P	P	P
9	15E31A0118	M AVINASHI	P	P	P	P	A	P	P	A	P	
10	15E31A0119	MADIRE NARESH	P	P	A	P	A	P	P	P		
11	15E31A0120	MD ABDUL MUNAM	P	A	P	P	P	P	A	P	A	
12	15E31A0121	MD SALMAN CHOUDHARY	P	P	P	A	P	P	A			



Principal
 MAHAVEER INSTITUTE OF SCIENCE & TECHNOLOGY
 Gandlaguda, Hyd-509 005

13	15E31A0122	MOHAMMED ETHESHAM	P	P	P	A	P	P	P	P	P	P
14	15E31A0123	MOHD AIMED NU BARAK ALI	A	P	P	P	P	P	P	P	P	P
15	15E31A0124	DAYANI	P	P	P	P	A	P	P	P	P	P
16	15E31A0125	SANTHOSH	A	P	P	P	P	P	P	P	P	P
17	15E31A0130	PITTALA RAJESH KUMAR	P	P	P	A	A	P	P	P	P	P
18	15E31A0131	SABIR ALIE	P	A	P	P	P	A	P	P	P	P
19	15E31A0133	SHEELAM PRAMOD KUMAR	P	P	P	D	A	P	P	A	P	P
20	15E31A0134	SIDDINI CHANDU	P	P	P	P	P	A	P	P	P	P
21	15E31A0140	KUMAR	P	P	P	A	P	P	P	P	P	A
22	15E31A0142	ZEESHAN ASHRAF	P	P	P	P	A	P	P	P	P	P
23	15E31A0143	M.A KHADER ANSARI	P	P	A	P	P	P	P	P	P	P
24	15E31A0144	PALOJU SRICHAITHANYA	P	P	A	P	P	P	P	A	P	P
25	15E31A0145	GOLLA VISHNU YADAV	P	P	P	P	A	P	P	P	P	P
26	16E35A0101	GADDAM CHARAN	P	P	P	A	P	P	P	P	P	P
27	16E35A0102	GUNDALA MANISH	P	A	A	P	P	P	P	P	P	P
28	16E35A0103	JANAPATI RAVI	P	P	P	P	A	P	P	P	P	P

PRINCIPAL
MAHARAJA
INSTITUTE OF SCIENCE & TECHNOLOGY
BANDLAGUDA, HYD-500 006



29	16E35A0104	M.PRASHANTH	P	P	P	A	P	P	A	P	P	P
30	16E35A0105	M.RANJITHA	P	P	P	P	A	P	P	P	P	P
31	16E35A0107	P.PRAVALIKA	P	P	P	P	P	P	A	P	P	P
32	16E35A0108	POGAKU KEERTHI MADIURI	P	P	A	P	P	P	P	P	P	P
33	16E35A0109	REDAPAKA MAHESHWARI	A	P	P	P	P	A	P	P	P	P
34	14E31A0102	ABDUR RAHEEM MUNNAWAR	P	P	P	P	P	P	A	P	P	P
35	14E31A0133	MOHD ABDUL ALL FUZAIL	A	P	P	P	P	P	P	P	P	P



Kishor
PRINCIPAL
MANAJEER
INSTITUTE OF SCIENCE & TECHNOLOGY
 Banjara Hills, Hyderabad-500 085



DEPARTMENT OF CIVIL ENGINEERING

Technical Training Exam on Etabs Software

(A.Y-2017-18)

2x10=20 Marks

Answer All the Questions

1) Design of composite steel using etabs

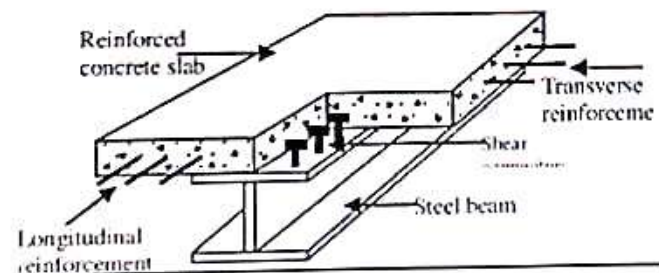

2) composite coloum using etabs



K. Srinivas
PRINCIPAL
MAHAVEER
INSTITUTE OF SCIENCE & TECHNOLOGY
Bandlaguda, Post: 500 005.

Vysapuri, Bandlaguda Post:Keshavgiri,
Hyderabad-500 005, Telangana INDIA
Tel: 040-64596979,20020773, Fax: 040-24455003
E-mail: principal.mahaveer@gmail.com,
Website: www.mist.ac.in,

MAHAVEER
INSTITUTE OF SCIENCE & TECHNOLOGY
Approved by AICTE, Affiliated to JNTUH,Hyd.

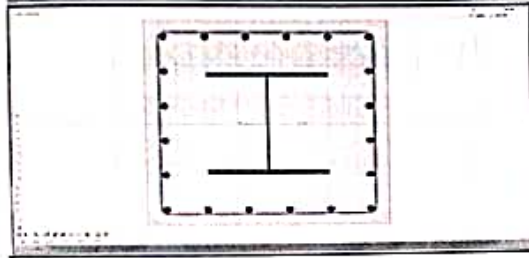

DEPARTMENT OF CIVIL ENGINEERING

Department of Mechanical Engineering
ETABS Technical Training student Marks list 2017-18

Sl.NO	Hall Ticket No	Name of the Candidate	YEAR	MARKS	PASS/FAIL
1	15E31A0101	A DIVISHA	III	16	PASS
2	15E31A0103	BAGUROTHUSAIUJWALA	III	16	PASS
3	15E31A0108	CHANDAVENKATESH	III	12	PASS
4	15E31A0109	DHADIVIJAY	III	12	PASS
5	15E31A0111	ELISHETTY TEJASWINI	III	16	PASS
6	15E31A0112	ERUKULLASRIKANTH	III	16	PASS
7	15E31A0115	GOPIPRANAY	III	16	PASS
8	15E31A0117	LOKASANISURENDERREDDY	III	16	PASS
9	15E31A0118	M AVINASH	III	16	PASS
10	15E31A0119	MADIRENARESH	III	16	PASS
11	15E31A0120	MD ABDULMUNAM	III	16	PASS
12	15E31A0121	MD SALMAN CHOUDHARY	III	16	PASS



K. Srinivas
PRINCIPAL
MAHAVEER
INSTITUTE OF SCIENCE & TECHNOLOGY
bandlaguda, Hyd-500 005.

Vysapuri, Bandlaguda Post:Keshavgi,
Hyderabad-509 005, Telangana INDIA
Tel: 040-84596979,20020773, Fax: 040-24455003
E-mail: principal.mahaveer@gmail.com
Website: www.mist.ac.in,

MAHAVEER

INSTITUTE OF SCIENCE & TECHNOLOGY
Approved by AICTE, Affiliated to JNTUH,Hyd.



13	15E31A0122	MOHAMMED ETHESHAM	III	16	PASS
14	15E31A0123	MOHDAHMED	III	16	PASS
15	15E31A0124	MUBARAK ALDAYANI	III	16	PASS
16	15E31A0125	NENAVATH SANTHOSH	III	16	PASS
17	15E31A0130	PITTALA RAJESH KUMAR	III	16	PASS
18	15E31A0131	SABIRALIE	III	16	PASS
19	15E31A0133	SHEELAM PRAMOD KUMAR	III	15	PASS
20	15E31A0134	SIDDINICHANDU	III	16	PASS
21	15E31A0140	VADLASHIRAVAN KUMAR	III	16	PASS
22	15E31A0142	ZEESHAN ASIRAF	III	15	PASS
23	15E31A0143	M A KHADERANSARI	III	16	PASS
24	15E31A0144	PALOJUSRICHAITHANYA	III	14	PASS
25	15E31A0145	GOLLAVISHINUYADAV	III	15	PASS
26	16E35A0101	GADDAM CHARAN	III	15	PASS
27	16E35A0102	GUNDALAMANISHI	III	16	PASS
28	16E35A0103	JANAPATIRAVI	III	14	PASS
29	16E35A0104	M PRASHANTHI	III	16	PASS
30	16E35A0105	M. RANJITHA	III	15	PASS
31	16E35A0107	P.PRAVALIKA	III	14	PASS
32	16E35A0108	POGAKUKEERTHIMADIHURI	III	18	PASS
33	16E35A0109	REDAPAKA MAHESHWARI	III	15	PASS
34	14E31A0102	ABDURRAHEEMMUNAWWAR	III	16	PASS
35	14E31A0133	MOHAMMED ABDULALIFUZAIL	III	15	PASS



K. Srinivas
PRINCIPAL
MAHAVEER
INSTITUTE OF SCIENCE & TECHNOLOGY
Bandlaguda, Hyd-509 005.

Vysapuri, Bandlaguda Post:Keshavgiri,
Hyderabad-500 005, Telangana INDIA
Tel: 040-84596979,20020773, Fax: 040-24455003
E-mail: principal.mahaveer@gmail.com,
Website: www.mist.ac.in,

MAHAVEER

INSTITUTE OF SCIENCE & TECHNOLOGY
Approved by AICTE. Affiliated to JNTUH,Hyd.



DEPARTMENT OF CIVIL ENGINEERING

Etabs course

Summary

Department of Civil Engineering

- Use ETABS for daily working process.
- Navigate throughout ETABS using major navigating tools.
- Understand the concept and techniques to draw.
- Create multiple designs using several of tools.
- Create layers to control the objects' visibility.
- Explain drawing using annotations.
- To use constraint for certain design.



Kshiraj
PRINCIPAL
MAHAVEER
INSTITUTE OF SCIENCE & TECHNOLOGY
Bandlaguda, Hyderabad-500 005.

Vysapuri, Bandlaguda Post:Keshavgiri,
Hyderabad-500 005, Telangana INDIA
Tel: 040-64596979,20020773, Fax: 040-24455003
E-mail: principal.mahaveer@gmail.com,
Website: www.mist.ac.in,

MAHAVEER

INSTITUTE OF SCIENCE & TECHNOLOGY
Approved by AICTE. Affiliated to JNTUH,Hyd.



CERTIFICATE OF COURSE COMPLETION

This certificate is presented to _____ of MIST, who has successfully completed technical training course on "ETABS" held from _____ to _____ and found the student performance to be excellent.



ESTD : 2001

CILSWETHAMBER

HOD

Civil Department



Keshav
PRINCIPAL
MAHAVEER
INSTITUTE OF SCIENCE & TECHNOLOGY
BANDLAGUDA POST, HYD-500 005.

Vysapuri, Bandlaguda Post:Keshavgiri,
Hyderabad-500 005, Telangana INDIA
Tel: 040-64596979,20020773, Fax: 040-24455003
E-mail: principal.mahaveer@gmail.com,
Website: www.mist.ac.in,

MAHAVEER

INSTITUTE OF SCIENCE & TECHNOLOGY

Approved by AICTE, Affiliated to JNTUH, Hyd.



PROPOSAL LETTER

Hyderabad,

25/08/2017.

To,
The principal,
MIST,
Hyderabad.

Sub: Proposal for three weeks workshop on GEOS-Reg,

Dear Sir,

We are working as asst professor in the department of CIVIL ENGINEERING. Sir, we are going to conduct three weeks workshop on GEOS. We require your approval to go head for further proceeding and hope to get an opportunity to serve you the best .

With thanks and Regards

From,
Civil Department
Mist,
Bandlaguda,
Hyderabad.



Kishu

PRINCIPAL
MAHAVEER
INSTITUTE OF SCIENCE & TECHNOLOGY
Bandlaguda, Hyd-500 005

Vysapuri, Bandlaguda Post:Keshavgiri,
Hyderabad-500 005, Telangana INDIA
Tel: 040-64596979,20020773, Fax: 040-24455003
E-mail: principal.mahaveer@gmail.com,
Website: www.mist.ac.in,

MAHAVEER
INSTITUTE OF SCIENCE & TECHNOLOGY
Approved by AICTE, Affiliated to JNTUH,Hyd.



Date: 01.09.2017

CIRCULAR

Technical Training for II B. Tech students are starting from 20th SEPTEMBER, 2017 onwards.
All HODs and Placements coordinators have to manage the trainings and ensure 95% attendance
all through the sessions.

All Mentors need to send the compiled feedback report to CH.SWETHAMBER, HOD at
e3hod.civil@gmail.com daily.

Agenda: 1. Introduction to GEO5 SOFTWARE

CH.SWETHAMBER
HOD

Design by: B.RAMANA KUMAR
B.RAJASHEKAR



K. S. S.

PRINCIPAL
MAHAVEER
INSTITUTE OF SCIENCE & TECHNOLOGY
Bandlaguda, Hyd-500 005.

Vysapuri, Bandlaguda Post-Keshavnagar,
Hyderabad-500 005, Telangana INDIA
Tel: 040-64594979, 20920773, Fax: 040-24455003
E-mail: principal.mahaveer@gmail.com
Website: www.mist.ac.in

MAHAVEER
INSTITUTE OF SCIENCE & TECHNOLOGY
Approved by AICTE, Affiliated to JNTUH, Hyd.



GEO5 SYLLABUS

Getting started with GEO5 SOFTWARE

- 1) Design of a cantilever wall
- 2) Verification of a gravity wall
- 3) Design of a non-anchored retaining wall
- 4) Design of an anchored retaining wall
- 5) Verification of a multi anchored wall
- 6) Slope stability analysis
- 7) Design of the geometry of a spread footing
- 8) Settlement of a spread footing
- 9) Analysis of a consolidation under embankment
- 10) Pile foundations-introduction

K. Srinivas
PRINCIPAL
MAHAVEER
INSTITUTE OF SCIENCE & TECHNOLOGY
Bandlaguda, Hyderabad



Vysapuri, Bandlaguda Post:Keshavgiri,
Hyderabad-500 005, Telangana INDIA
Tel: 040-64596979,20020773, Fax: 040-24455003
E-mail: principal.mahaveer@gmail.com,
Website: www.mist.ac.in,

MAHAVEER

INSTITUTE OF SCIENCE & TECHNOLOGY

Approved by AICTE, Affiliated to JNTUH,Hyd.



MAHAVEER INSTITUTE OF SCIENCE & TECHNOLOGY, HYDERABAD

B.TECH IV YEAR I SEM

CIVIL ENGINEERING 2017-18 BATCH

S.No	Hall Ticket No	Name of the Candidate	Year
1	14E31A0101	A SRIKANTH	IV
2	14E31A0103	AMBATI NEELIMA	IV
3	14E31A0104	ANKITH KUMAR TIWARI	IV
4	14E31A0105	AREF ABDUR RAHMAN AL KASERI	IV
5	14E31A0106	AVULA AJAYA LAKSHMI	IV
6	14E31A0107	BATHARAJU ARUN KUMAR	IV
7	14E31A0108	BATTHINI VINAY	IV
8	14E31A0109	BEJJURI PRASHANTH	IV
9	14E31A0111	BOINPELLI SHRUTHI	IV
10	14E31A0112	BUDUGULA KIRAN KUMAR	IV
11	14E31A0113	CHITIKESHI OMPRAKASHI	IV
12	14E31A0114	EPPA OMPRAKASHI	IV
13	14E31A0115	FAIZAN BAIG	IV
14	14E31A0116	GADDAVARI SHIVA KRISHNA	IV
15	14E31A0117	GANDLA SUHRUDI	IV
16	14E31A0118	GORLA SHRAVANI	IV
17	14E31A0119	GOTTE TEJASWEI	IV
18	14E31A0120	ISLAVATH PAVANKUMAR	IV
19	14E31A0121	JADHAV SAI KRISHNA	IV

K. Subh
PRINCIPAL
MAHAVEER
INSTITUTE OF SCIENCE & TECHNOLOGY
Bandlaguda, Hyderabad-500 005



20	14E31A0122	KONUGANTI NIKHIL REDDY	IV
21	14E31A0123	MAJJARI CHANDRA SHEKHAR	IV
22	14E31A0124	MASARATH JAIHAN	IV
23	14E31A0125	MEKAPOTHULA SANDEEP	IV
24	14E31A0126	MIR SIDDIQ MUQTADIR ALI HASHIMI	IV
25	14E31A0127	MOGILI LIKHITHA	IV
26	14E31A0128	MOGULAM ROHITH	IV
27	14E31A0129	MOHAMMED AIRAJ MOHIUDDIN	IV
28	14E31A0130	MOHAMMED ASIM SULEMAN	IV
29	14E31A0131	MOHAMMED JAWAD UDDIN	IV
30	14E31A0134	MOHD ABDUL RAOOF	IV
31	14E31A0136	MOHD IBRAHIMA FARUQE	IV
32	14E31A0137	MOHD MOHIUDDIN FAIZ	IV
33	14E31A0139	NAARSING AISHWARYA	IV
34	14E31A0140	NIMMALA THIRUPATHI	IV
35	14E31A0141	PALAM SRIKANTH REDDY	IV
36	14E31A0142	PERAPOGU SHASHI KIRAN	IV
37	14E31A0144	RAVINOTHALA NARENDRA BABU	IV
38	14E31A0145	SAYYAD SOHEL	IV
39	14E31A0147	SHAIK RAHIL FARAZ	IV
40	14E31A0148	SILUVERI MADHUKAR	IV
41	14E31A0149	SOMA SRILATHA	IV
42	14E31A0150	SYED ISMAIL	IV
43	14E31A0151	SYED KALEEM ULLAH QUADRI	IV
44	14E31A0152	SYED MOHAMMED FIRDOUSE	IV

PRINCIPAL
MAHAVEER
 INSTITUTE OF SCIENCE & TECHNOLOGY
 Bandlaguda, Hyd-500 082

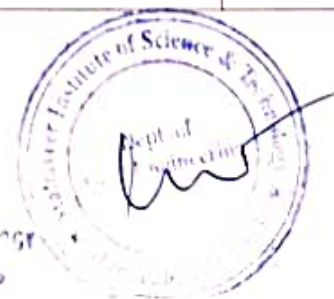

45	14E31A0153	SYED MUSTAFA ALI	IV
46	14E31A0154	SYED NUMAN	IV
47	14E31A0155	SYED SAAD SHAREEF	IV
48	14E31A0157	VAISHNAVI UPADHYAY	IV
49	14E31A0158	VANAPARTHI SANTHOSH VARMA	IV
50	14E31A0159	DEMULA AVINASHI	IV
51	15E35A0101	ALTAF AHMED	IV
52	15E35A0102	B SAI KRISHINA	IV
53	15E35A0103	BORRA RAGHU RAM	IV
54	15E35A0104	GANGULA RATHINA KUMAR	IV
55	15E35A0105	KASTHOORI VENKATAKRISHNA	IV
56	15E35A0106	MD JUNED	IV
57	15E35A0107	METHUKU SAGAR REDDY	IV
58	15E35A0108	MOHAMMED NADEEMUDDIN	IV
59	15E35A0109	NALLA SHESHU VARDHAN REDDY	IV
60	15E35A0110	NALLAPU VEERA HANUMANTHA RAO	IV
61	15E35A0112	V KAVITHA	IV
62	13E31A0102	ABDUL RAHMAN BIN HASSAN AL YAFAI	IV
63	13E31A0105	AMBALA RAJKUMAR	IV
64	13E31A0138	MUSKU SANTOSH	IV
65	13E31A0113	DABBA ROHITH	IV

K. S. S.

PRINCIPAL
MAHAVEER

INSTITUTE OF SCIENCE & TECHNOLOGY
Bandlaguda, Hyderabad 500 082



MAHAVEER INSTITUTE OF SCIENCE & TECHNOLOGY, HYDERABAD
CIVIL ENGINEERING STUDENTS ATTENDANCE

B.TECH IV YEAR I SEM 2017-2018 BATCH (Date :20-09-2017 to 30-10-2017)

S.No	Hall Ticket No	Name of the Candidate	1	2	3	4	5	6	7	8	9	10
1	14E31A0101	A SRIKANTH	P	P	P	A	P	P	P	P	A	P
2	14E31A0103	AMBATI NEELIMA	A	P	P	P	P	P	P	P	P	P
3	14E31A0104	ANKITH KUMAR TIWARI	P	P	P	P	P	P	A	P	P	P
4	14E31A0105	AREF ABDU R RAHMAN AL KASERI	P	P	P	P	P	P	P	P	A	P
5	14E31A0106	AVULA AJAYA LAKSHMI	A	P	P	P	P	P	P	P	P	P
6	14E31A0107	BATHARAJU ARUN KUMAR	P	P	P	P	P	P	P	P	P	P
7	14E31A0108	BATTHINI VINAY	P	P	P	P	P	P	P	P	P	A
8	14E31A0109	BEJURI PRASHANTH	P	P	P	P	P	P	P	P	P	P
9	14E31A0111	BOINPELLI SHRUTHI	P	P	P	P	P	P	P	P	P	P
10	14E31A0112	BUDUGULA KIRAN KUMAR	P	P	P	P	P	A	P	P	P	P
11	14E31A0113	CHITIKESHI OMPRAKASH	P	P	P	P	P	P	P	P	A	P
12	14E31A0114	EPPA OMPRAKASH	P	P	P	P	P	P	P	P	P	P
13	14E31A0115	FAIZAN BAIG	P	P	P	P	P	P	P	P	P	P
14	14E31A0116	GADDAVARI SHIVA KRISHNA	P	P	P	P	P	P	P	P	P	P
15	14E31A0117	GANDLA SUHRUDH	P	P	P	P	P	P	P	P	P	P
16	14E31A0118	GORLA SHRAVANI	P	P	P	P	P	P	P	P	P	P
17	14E31A0119	GOTTE TEJASWEI	P	P	P	P	P	A	P	P	P	P
18	14E31A0120	ISLAVATH PAVANKUMAR	P	A	P	P	P	P	P	P	P	P
19	14E31A0121	JADHAV SAI KRISHNA	P	P	P	P	P	P	A	P	P	P
20	14E31A0122	KONUGANTI NIKHIL REDDY	P	P	A	P	P	P	P	A	P	P
21	14E31A0123	MAJJARI CHANDRA SHEKHAR	P	P	P	P	P	P	P	P	P	P
22	14E31A0124	MASARATH JAHAN	P	A	P	P	A	P	P	P	P	P
23	14E31A0125	MEKAPOTHULA SANDEEP	P	P	P	P	P	P	P	A	P	P
24	14E31A0126	MIR SIDDIQ MUQTADIR ALI HASHMI	P	P	P	P	P	P	P	P	P	P
25	14E31A0127	MOGILI LIKHITHA	P	P	P	P	P	P	P	P	P	P
26	14E31A0128	MOGULAM ROHITH	A	P	P	P	A	P	P	P	P	P
27	14E31A0129	MOHAMMED AIRAJ MOHIUDDIN	P	P	P	P	P	A	P	P	P	P
28	14E31A0130	MOHAMMED ASIM SULEMAN	P	P	P	P	P	P	P	P	P	P
29	14E31A0131	MOHAMMED JAWAD UDDIN	P	P	P	P	P	P	P	P	P	P
30	14E31A0134	MOHD ABDUL RAOOF	A	P	P	P	P	P	P	P	P	P
31	14E31A0136	MOHD IBRAHIMA FARUQE	P	P	P	P	P	P	P	P	P	P
32	14E31A0137	MOHD MOHIUDDIN FAIZ	P	P	P	P	P	P	P	P	P	P



PRINCIPAL
MAHAVEER
 INSTITUTE OF SCIENCE & TECHNOLOGY
 Bandlaguda, Hyd-500 005.

Vysapuri, Bandlaguda Post:Keshavgiri,
Hyderabad-500 005, Telangana INDIA
Tel: 040-64596979,20020773, Fax: 040-24455003
E-mail: principal.mahaveer@gmail.com,
Website: www.mist.ac.in,

MAHAVEER
INSTITUTE OF SCIENCE & TECHNOLOGY
Approved by AICTE, Affiliated to JNTUH,Hyd.



Technical Training Exam on GEO5 Software
(A.Y-2017-18)

2x10=20 Marks

Answer All the Questions

1. What is FLAC SOFTWARE ?
2. What is optimum G2?



K. Srinivas

PRINCIPAL
MAHAVEER
INSTITUTE OF SCIENCE & TECHNOLOGY
Bandlaguda, Hyd-500 005.

Vysapuri, Bandlaguda Post:Keshavgirl,
Hyderabad-500 005, Telangana INDIA
Tel: 040-64596979,20020773, Fax: 040-24455003
E-mail: principal.mahaveer@gmail.com,
Website: www.mist.ac.in,

MAHAVEER
INSTITUTE OF SCIENCE & TECHNOLOGY
Approved by AICTE, Affiliated to JNTUH,Hyd.



MAHAVEER INSTITUTE OF SCIENCE & TECHNOLOGY, HYDERABAD					
B.TECH IV YEAR I SEM					
CIVIL ENGINEERING 2017-18 BATCH					
S.No	Hall Ticket No	Name of the Candidate	Year	Marks	Pass/Fail
1	14E31A0101	A SRIKANTH	IV	16	Pass
2	14E31A0103	AMBATI NEELIMA	IV	15	Pass
3	14E31A0104	ANKITH KUMAR TIWARI	IV	14	Pass
4	14E31A0105	AREF ABDUR RAHMAN AL KASERI	IV	15	Pass
5	14E31A0106	AVULA AJAYA LAKSHMI	IV	12	Pass
6	14E31A0107	BATHARAJU ARUN KUMAR	IV	13	Pass
7	14E31A0107	BATHARAJU ARUN KUMAR	IV	14	Pass
7	14E31A0108	BATTHINI VINAY	IV	16	Pass
8	14E31A0109	BEJJURI PRASHANTH	IV	15	Pass
9	14E31A0111	BOINPELLI SHRUTHI	IV	14	Pass
10	14E31A0112	BUDUGULA KIRAN KUMAR	IV	14	Pass
11	14E31A0113	CHITIKESHI OMPRAKASHI	IV	13	Pass
12	14E31A0114	EPPA OMPRAKASHI	IV	14	Pass
13	14E31A0115	FAIZAN BAIG	IV	12	Pass
14	14E31A0116	GADDAVARI SHIVA KRISHINA	IV	15	Pass
15	14E31A0117	GANDLA SUHRUDI	IV	14	Pass
16	14E31A0118	GORLA SHRAVANI	IV	15	Pass
17	14E31A0119	GOTTE TEJASWEI	IV	14	Pass

Kshy
500 005, Hyderabad
MAHAVEER
INSTITUTE OF SCIENCE & TECHNOLOGY
Hyderabad-500 005.



18	14E31A0120	ISLAVATH PAVANKUMAR	IV	12	Pass
19	14E31A0121	JADHAV SAI KRISHNA	IV	15	Pass
20	14E31A0122	KONUGANTI NIKHIL REDDY	IV	16	Pass
21	14E31A0123	MAJJARI CHANDRA SHEKHAR	IV	15	Pass
22	14E31A0124	MASARATH JAHAN	IV	14	Pass
23	14E31A0125	MEKAPOTHULA SANDEEP	IV	15	Pass
24	14E31A0126	MIR SIDDIQ MUQTADIR ALI HASHMI	IV	16	Pass
25	14E31A0127	MOGILI LIKHITHA	IV	15	Pass
26	14E31A0128	MOGULAM ROHITH	IV	14	Pass
27	14E31A0129	MOHAMMED AIRAJ MOHIUDDIN	IV	15	Pass
28	14E31A0130	MOHAMMED ASIM SULEMAN	IV	12	Pass
29	14E31A0131	MOHAMMED JAWAD UDDIN	IV	13	Pass
30	14E31A0134	MOHD ABDUL RAOOF	IV	14	Pass
31	14E31A0136	MOHD IBRAHIMA FARUQE	IV	12	Pass
32	14E31A0137	MOHD MOHIUDDIN FAIZ	IV	16	Pass
33	14E31A0139	NAARSING AISHWARYA	IV	15	Pass
34	14E31A0140	NIMMALA THIRUPATHI	IV	13	Pass
35	14E31A0141	PALAM SRIKANTH REDDY	IV	12	Pass
36	14E31A0142	PERAPOGU SHASHI KIRAN	IV	13	Pass
37	14E31A0144	RAVINOTHALA NARENDRA BABU	IV	15	Pass
38	14E31A0145	SAYYAD SOHEL	IV	16	Pass
39	14E31A0147	SHAIK RAHIL FARAZ	IV	14	Pass
40	14E31A0148	SILUVERI MADHUKAR	IV	12	Pass
41	14E31A0149	SOMA SRILATHA	IV	13	Pass
42	14E31A0150	SYED ISMAIL	IV	13	Pass

PRINCIPAL
MAHAVEER
 INSTITUTE OF SCIENCES & TECH.
 Bandlaguda, Hyd-500 022.



43	14E31A0151	SYED KALEEM ULLAH QUADRI	IV	15	Pass
44	14E31A0152	SYED MOHAMMED FIRDOUSE	IV	16	Pass
45	14E31A0153	SYED MUSTAFA ALI	IV	14	Pass
46	14E31A0154	SYED NUMAN	IV	15	Pass
47	14E31A0155	SYED SAAD SHAREEF	IV	13	Pass
48	14E31A0157	VAISHNAVI UPADHYAY	IV	12	Pass
49	14E31A0158	VANAPARTHI SANTHOSH VARMA	IV	12	Pass
50	14E31A0159	VEMULA AVINASHI	IV	15	Pass
51	13E31A0102	ABDUL RAHMAN BIN HASSAN AL YAFAI	IV	15	Pass
52	15E35A0101	ALTAF AHMED	IV	16	Pass
53	15E35A0102	B SAI KRISHNA	IV	12	Pass
54	15E35A0103	BORRA RAGHU RAM	IV	13	Pass
55	15E35A0104	GANGULA RATINA KUMAR	IV	15	Pass
56	15E35A0105	KASTHOORI VENKATAKRISHNA	IV	16	Pass
57	15E35A0106	MD JUNED	IV	16	Pass
58	15E35A0107	METHUKU SAGAR REDDY	IV	15	Pass
59	15E35A0108	MOHAMMED NADEEMUDDIN	IV	13	Pass
60	15E35A0109	NALLA SHESHU VARDHAN REDDY	IV	14	Pass
61	15E35A0110	NALLAPU VEERA HANUMANTHA RAO	IV	14	Pass
62	15E35A0112	V KAVITHA	IV	12	Pass
63	13E31A0103	ABDUL RAHMAN BIN HASSAN AL YAFAI	IV	12	Pass
64	13E31A0105	AMBALA RAJKUMAR	IV	13	Pass
65	13E31A0138	MUSKU SANTOSHI	IV	12	Pass
66	13E31A0113	DABBA ROHITHI	IV	13	Pass

PRINCIPAL
MAHAVEER
 INSTITUTE OF SCIENCE & TECH.
 Barkulaguda, Hyd-500 605.



Vysapuri, Bandlaguda Post:Keshavgiri,
Hyderabad-500 005, Telangana INDIA
Tel: 040-64596979,20020773, Fax: 040-24455003
E-mail: principal.mahaveer@gmail.com,
Website: www.mist.ac.in,

MAHAVEER

INSTITUTE OF SCIENCE & TECHNOLOGY

Approved by AICTE, Affiliated to JNTUH,Hyd.



GEO5 COURSE

Summary

Department of Civil Engineering

- Use GEO5 for daily working process.
- Navigate throughout GEO5 using major navigating tools.
- Understand the concept and techniques to draw.
- Create multiple designs using several of tools.
- Create layers to control the objects' visibility.
- Explain drawing using annotations.
- Plot or print the drawing by scale.
- To use constraint for certain design.



K. Subh
PRINCIPAL
MAHAVEER
INSTITUTE OF SCIENCE & TECHNOLOGY
Bandlaguda, Hyd- 500 005.

Vysapuri, Bandlaguda Post:Keshavgi,
Hyderabad-500 005, Telangana INDIA
Tel: 040-64596979,20020773, Fax: 040-24455003
E-mail: principal.mahaveer@gmail.com,
Website: www.mist.ac.in,

MAHAVEER

INSTITUTE OF SCIENCE & TECHNOLOGY

Approved by AICTE, Affiliated to JNTUH,Hyd.



CERTIFICATE OF COURSE COMPLETION

This certificate is presented to _____ of MIST, who has successfully completed technical training course on "GEO5" held from _____ to _____ and found the student performance to be excellent.



ESTD : 2001

CH.SWETHAMBER

HOD



K. Subhag

PRINCIPAL

MAHAVEER

INSTITUTE OF SCIENCE & TECHNOLOGY

Bandlaguda, Hyd-500 005.

Vysapuri, Bandlaguda Post:Keshavgiri,
Hyderabad-500 005, Telangana INDIA
Tel: 040-64596979,20020773, Fax: 040-24455003
E-mail: principal.mahaveer@gmail.com,
Website: www.mist.ac.in,

MAHAVEER
INSTITUTE OF SCIENCE & TECHNOLOGY
Approved by AICTE, Affiliated to JNTUH,Hyd



PROPOSAL LETTER

Hyderabad,

08/03/2017.



To
The principal,
MIST,
Hyderabad.

Sub: Proposal for three weeks workshop on STADD PROVIB-Reg,

Dear Sir,

We are working as asst professor in the department of CIVIL ENGINEERING. Sir, we are going to conduct three weeks workshop on STADD PROVIB. We require your approval to go head for further proceeding and hope to get an opportunity to serve you the best .

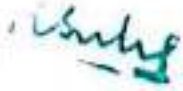
With thanks and Regards



**PRINCIPAL
MAHAVEER**
INSTITUTE OF SCIENCE & TECHNOLOGY
Bandlaguda Post, Hyderabad-500005

From,
Civil Department,
Mist,
Bandlaguda,
Hyderabad.

Vysapuri, Bandlaguda Post:Keshavgiri,
Hyderabad-500 005, Telangana INDIA
Tel: 040-64596979,20020773, Fax: 040-24455003
E-mail: principal.mahaveer@gmail.com,
Website: www.mist.ac.in,

MAHAVEER

INSTITUTE OF SCIENCE & TECHNOLOGY
Approved by AICTE, Affiliated to JNTUH,Hyd.



Date: 10.03.2017

CIRCULAR

Technical Training for II B. Tech students are starting from 10th March, 2017 onwards. All HODs and Placements coordinators have to manage the trainings and ensure 95% attendance all through the sessions.

All Mentors need to send the compiled feedback report to, HOD at e3hod.civil@gmail.com daily.

Agenda: 1. Introduction to STAAD ProVi8.

DESIGNED BY

**M. SAI KUMAR SAGAR
K. SAI PRADEEP**

CHISWETHAMBER

HOD

Kishu
PRINCIPAL
MAHAVEER
INSTITUTE OF SCIENCE & TECHNOLOGY
Bandlaguda, Hyderabad-500005

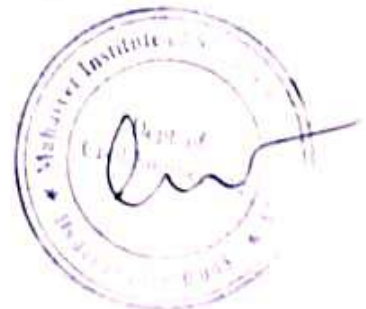



STAAD.ProVi8 SYLLABUS

Chapter 1: Before you start using Bentley STAAD.ProVi8

- h. Understanding Unit Conversion Tables
- i. Overview of Structural Design & Analysis
- j. Stresses and Stains
- k. Shear Force & Bending Moment Diagrams
- l. Introduction to Types of Structures
- m. Overview of Steel, Concrete and Foundation Design
- n. Introduction to Finite Element Analysis

Chapter 2: Introduction to STAAD.Pro

- l. About Bentley STAAD.Pro
- m. Starting STAAD.Pro
- n. Graphical User Interface
- o. Starting a New Project
- p. Working with User Interface:
 - Menu Bars
 - Tool Bars
 - Tabs
 - Snap Node / Beam Window
 - Data Area
 - Main Window
- q. Opening and Existing Project
- r. Saving a Project
- s. Configuring Units
- t. Keyboard Shortcuts
- u. Importing Model in STAAD.Pro
- v. Coordinate Systemes

Chapter 3: Structural Modeling

- l. Adding Beams using Tools
- m. Creating Beams (Colinear, Along Axes)
- n. Creating Plates
- o. Creating Surfaces
- p. Creating Solid Elements
- q. Creating Structure
- r. Stretching and Intersecting Members
- s. Merging Members and Nodes
- t. Renumbering Nodes, Members and Elements
- u. Splitting and Breaking Beams
- v. Cutting Sections

Chapter 4: Material Constants and Section Properties

- f. Material Constants
- g. Creating and Editing Material Properties
- h. Assigning Materials to the Structure
- i. Orthotropic Materials
- j. Section Properties
 - Prismatic Sections
 - Tapered Sections

K. Mahaveer

PRINCIPAL
MAHAVEER
INSTITUTE OF SCIENCE & TECHNOLOGY
bandlaguda, hyd 500005.



- Steel Sections
- Steel Joist and JoistGirders
- Plate/SurfaceThickness

Chapter 5: Member Specifications and Supports

- e. NodeSpecification
- f. MemberSpecifications
 - Release
 - Offset
 - Property Reductionfactors
 - Cable
 - Truss
 - Compression
 - Tension
 - Inactive
- g. PlateSpecifications
 - Release
 - ignore InplaneRotation
 - PlaneStress
- h. Supports:
 - Fixed
 - Pinned
 - FixedBut
 - Enforced
 - EnforcedBut
 - MultilinearSpring
 - Foundation
 - Inclined
 - Tension/Compression OnlySprings

Chapter 6: Loads

- d. Types of Loads: Selfweight, Nodal, Member, Area, Floor, Plate, Surface andSolid,
- e. LoadGeneration
- f. LoadCombinations

Chapter 7: Performing Analysis

- c. PreAnalysis
 - ProblemStatistics
 - JointCoordinates
 - MemberInformation
 - MaterialProperties
 - SupportInformation
 - Element & SolidInformation
- d. PerformingAnalysis

Chapter 8: Post Processing & Report Creation

- e. Post AnalysisPrint
 - LoadLists
 - JointDisplacement
 - MemberForces
 - SupportReactions
 - EG
 - ModeShapes
 - SectionDisplacement
 - Analysis Results
 - MemberStresses
 - ElementForces/Stresses
- f. ViewingResults

K. K. Mahaveer

**PRINCIPAL
MAHAVEER**

INSTITUTE OF SCIENCE & TECHNOLOGY
Bangalore, 560 075



- g. Output File
- h. Post Processing Mode

Chapter 9: Analysis Case Studies / Workshops

- e. RCC Design & Analysis (Beams and Columns)
- f. Steel Design & Analysis (Frames and Trusses)
- g. Miscellaneous Analysis
- h. Practice examples for Students

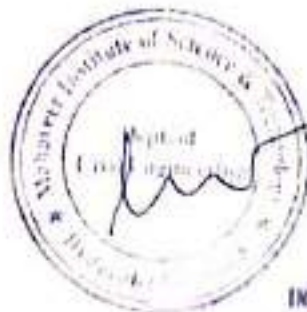

Manaveer

PRINCIPAL
MANAVEER
INSTITUTE OF SCIENCE & TECHNOLOGY
Bangalore, Hydr-500 009.



Department of Mechanical Engineering STAAD PROV8 Technical Training student attendance list 2017-18

SL.NO.	ROLL NO.	NAME OF THE STUDENT	YEAR
1	14E31A0101	A SRIKANTH	IV
2	14E31A0103	AMBATI NEELIMA	IV
3	14E31A0104	ANKITH KUMAR TIWARI	IV
4	14E31A0105	AREF ABDUR RAHMAN AL KASERI	IV
5	14E31A0106	AVULA AJAYA LAKSHMI	IV
6	14E31A0107	BATHARAJU ARUN KUMAR	IV
7	14E31A0108	BATTHINI VINAY	IV
8	14E31A0109	BEJJURI PRASHANTH	IV
9	14E31A0111	BOINPELLI SHRUTHI	IV
10	14E31A0112	BUDUGULA KIRAN KUMAR	IV
11	14E31A0113	CHITIKESHI OMPRAKASH	IV
12	14E31A0114	EPPA OMPRAKASH	IV
13	14E31A0115	FAIZAN BAIG	IV
14	14E31A0116	GADDAVARI SHIVA KRISHNA	IV
15	14E31A0117	GANDLA SUHRUDH	IV
16	14E31A0118	GORLA SHRAVANI	IV
17	14E31A0119	GOTTE TEJASWEI	IV
18	14E31A0120	ISLAVATH PAVANKUMAR	IV
19	14E31A0121	JADHAV SAI KRISHNA	IV
20	14E31A0122	KONUGANTI NIKHIL REDDY	IV
21	14E31A0123	MAJJARI CHANDRA SHEKHAR	IV
22	14E31A0124	MASARATH JAHAN	IV
23	14E31A0125	MEKAPOTHULA SANDEEP	IV
24	14E31A0126	MIR SIDDIQ MUQTADIR ALI HASHMI	IV
25	14E31A0127	MOGLI LIKHITHA	IV
26	14E31A0128	MOGULAM ROHITH	IV
27	14E31A0129	MOHAMMED AIRAJ MOHIUDDIN	IV
28	14E31A0130	MOHAMMED ASIM SULEMAN	IV
29	14E31A0131	MOHAMMED JAWAD UDDIN	IV
30	14E31A0134	MOHD ABDUL RAOOF	IV
31	14E31A0136	MOHD IBRAHIMA FARUQE	IV



K. Srinivas
PRINCIPAL
MAHAVEER
INSTITUTE OF SCIENCE & TECHNOLOGY
Bandlaguda, 500005

32	14E31A0137	MOHD MOHIUDDIN FAIZ	IV
33	14E31A0139	NAARSING AISHWARYA	IV
34	14E31A0140	NIMMALA THIRUPATHI	IV
35	14E31A0141	PALAM SRIKANTH REDDY	IV
36	14E31A0142	PERAPOGU SHASHI KIRAN	IV
37	14E31A0144	RAVINTHALA NARENDRA BABU	IV
38	14E31A0145	SAYYAD SOHEL	IV
39	14E31A0147	SHAIK RAHIL FARAZ	IV
40	14E31A0148	SILUVERI MADHUKAR	IV
41	14E31A0149	SOMA SRILATHA	IV
42	14E31A0150	SYED ISMAIL	IV
43	14E31A0151	SYED KALEEM ULLAH QUADRI	IV
44	14E31A0152	SYED MOHAMMED FIRDOUSE	IV
45	14E31A0153	SYED MUSTAFA ALI	IV
46	14E31A0154	SYED NUMAN	IV
47	14E31A0155	SYED SAAD SHAREEF	IV
48	14E31A0157	VAISHNAVI UPADHYAY	IV
49	14E31A0158	VANAPARTHI SANTHOSH VARMA	IV
50	14E31A0159	VEMULA AVINASH	IV
51	15E35A0101	ALTAH AHMED	IV
52	15E35A0102	B SAI KRISHNA	IV
53	15E35A0103	BORRA RAGHU RAM	IV
54	15E35A0104	GANGULA RATHNA KUMAR	IV
55	15E35A0105	KASTHOORI VENKATAKRISHNA	IV
56	15E35A0106	MD JUNED	IV
57	15E35A0107	METHUKU SAGAR REDDY	IV
58	15E35A0108	MOHAMMED NADEEMUDDIN	IV
59	15E35A0109	NALLA SHESHU VARDHAN REDDY	IV
60	15E35A0110	NALLAPU VEERA HANUMANATHA RAO	IV
61	15E35A0112	V KAVITHA	IV
62	13E31A0102	ABDUL RAHMAN BIN HASSAN AL YAFAI	IV
63	13E31A0105	AMBALA RAJKUMAR	IV
64	13E31A0138	MUSKU SANTOSH	IV
65	13E31A0113	DABBA ROHITH	IV

K. S. S.

PRINCIPAL
MAHAVEER

INSTITUTE OF SCIENCE & TECHNOLOGY
NANDIGAM, HYD-500 005.



MAHAVEER INSTITUTE OF SCIENCE & TECHNOLOGY, HYDERABAD
CIVIL ENGINEERING STUDENTS ATTENDANCE

B.TECH IV YEAR II SEM 2017-2018 BATCH (Date - 10/03/2017 - 21/01/2017)

S.No	No	Name of the Candidate	1	2	3	4	5	6	7	8	9	10
1	14E31A0101	A SRIKANTH	A	P	P	P	P	P	P	P	P	P
2	14E31A0103	AMBATI NEELIMA	P	P	P	P	P	A	P	P	P	P
3	14E31A0104	ANKITH KUMAR TIWARI	P	P	A	P	P	P	P	P	P	P
4	14E31A0105	AREF ABDUR RAHMAN AL KASERI	P	P	P	P	P	P	A	A	P	P
5	14E31A0106	AVULA AJAYA LAKSHMI	P	P	P	P	A	P	P	P	P	P
6	14E31A0107	BATHARAJU ARUN KUMAR	A	P	P	P	P	P	P	P	P	P
7	14E31A0108	BATTINI VINAY	P	P	P	P	A	P	P	P	P	P
8	14E31A0109	BEJURI PRASHANTH	P	P	P	P	P	P	P	A	P	P
9	14E31A0111	BOINPELLI SHRUTHI	P	P	P	P	P	A	P	P	P	P
10	14E31A0112	BUDUGULA KIRAN KUMAR	P	P	P	A	P	P	P	P	P	P
11	14E31A0113	CHITIKESHI OMPRAKASH	P	P	P	P	P	A	P	P	P	P
12	14E31A0114	EPPA OMPRAKASH	P	P	A	P	P	P	P	P	P	P
13	14E31A0115	FAIZAN BAIG	P	P	P	P	P	A	P	P	P	P
14	14E31A0116	GADDAVARI SHIVA KRISHNA	P	P	P	P	P	P	P	A	P	P
15	14E31A0117	GANDLA SUHRUDH	P	P	P	A	P	P	P	P	P	P
16	14E31A0118	GORLA SHRAVANI	P	P	P	P	P	P	A	P	P	P
17	14E31A0119	GOTTE TEJASWEI	P	A	P	P	P	P	P	P	P	P
18	14E31A0120	ISLAVATH PAVANKUMAR	P	P	P	P	P	P	P	P	P	A
19	14E31A0121	JADHAV SAI KRISHNA	A	P	P	P	P	P	P	P	P	P
20	14E31A0122	KONUGANTI NIKHIL REDDY	P	P	P	A	P	P	P	P	P	P
21	14E31A0123	MAJARI CHANDRA SHEKHAR	P	P	P	P	P	P	P	P	P	A
22	14E31A0124	MASARATH JAHAN	P	P	A	P	P	P	P	P	P	P
23	14E31A0125	MEKAPOTHULA SANDEEP	P	P	P	P	P	P	P	P	P	A
24	14E31A0126	MIR SIDDIQ MUQTADIR ALI HASIMI	P	P	P	P	A	P	P	P	P	P
25	14E31A0127	MOGILI LIKHITHA	A	P	P	P	P	P	P	P	P	P



PRINCIPAL
MAHAVEER
 INSTITUTE OF SCIENCE & TECHNOLOGY
 Randlaguda, Hyd-500 005.

26	14E31A0128	MOGULAM ROHITH	P	P	P	A	P	P	A	D	P	P
27	14E31A0129	MOHAMMED AIRAJ MOHIUDDIN	P	P	P	P	P	P	P	P	A	P
28	14E31A0130	MOHAMMED ASIM SULEMAN	P	P	A	P	P	P	A	P	P	P
29	14E31A0131	MOHAMMED JAWAD UDDIN	P	P	P	P	P	P	P	A	P	P
30	14E31A0134	MOHD ABDUL RAOOF	P	P	P	P	P	A	P	P	P	P
31	14E31A0136	MOHD IBRAHIMA FARUQE	P	P	A	P	P	P	P	A	P	P
32	14E31A0137	MOHD MOHIUDDIN FAIZ	P	P	P	P	P	P	P	P	P	P
33	14E31A0139	NAARSING AISHWARYA	P	P	P	A	P	P	A	P	P	P
34	14E31A0140	NIMMALA THIRUPATHI	P	P	P	P	P	P	P	P	P	P
35	14E31A0141	PALAM SRIKANTH REDDY	P	P	A	P	P	P	A	P	P	P
36	14E31A0142	PERAPOGU SHASHI KIRAN	P	P	P	P	P	A	P	P	A	D
37	14E31A0144	RAVINOHALA NARENDRA BABU	P	P	A	P	P	P	P	P	P	P
38	14E31A0145	SAYYAD SOHEL	P	P	P	P	P	A	P	P	P	P
39	14E31A0147	SHAIK RAHIL FARAZ	P	P	P	P	P	P	P	A	P	P
40	14E31A0148	SILUVERI MADHUKAR	A	P	P	P	P	P	P	P	P	P
41	14E31A0149	SOMA SRILATHA	P	P	P	P	A	P	P	P	P	P
42	14E31A0150	SYED ISMAIL	P	P	P	P	P	P	A	P	P	P
43	14E31A0151	SYED KALEEM ULLAH QUADRI	P	P	P	P	P	P	P	A	P	A
44	14E31A0152	SYED MOHAMMED FIRDOUSE	A	P	A	P	P	P	P	P	P	P
45	14E31A0153	SYED MUSTAFA ALI	P	P	P	P	P	P	P	P	P	P
46	14E31A0154	SYED NUMAN	P	P	A	P	P	A	P	P	P	P
47	14E31A0155	SYED SAAD SHAREEF	P	P	P	P	P	P	P	P	P	P
48	14E31A0157	VAISHNAVI UPADHYAY	P	A	P	A	P	P	P	P	P	P
49	14E31A0158	VANAPARTHI SANTHOSH VARMA	P	P	P	P	A	P	P	A	P	P
50	14E31A0159	VEMULA AVINASH	P	P	A	P	P	P	P	P	A	P
51	15E35A0101	ALTAJ AHMED	P	A	P	P	A	P	P	P	P	P
52	15E35A0102	B SAI KRISHNA	P	P	P	P	P	A	P	P	A	D
53	15E35A0103	BORRA RAGHU RAM	P	A	P	P	P	P	P	P	P	A
54	15E35A0104	GANGULA RATHNA KUMAR	P	P	P	P	P	P	P	P	P	P
55	15E35A0105	KASTHOORI VENKATAKRISHNA	A	P	P	P	P	A	P	P	P	P



Sathy

PRINCIPAL
MAHAVEER
INSTITUTE OF SCIENCE & TECHNOLOGY
Randlaguda, Hyd-500 005.

56	15E35A0106	MD JUNED	A	P	P	P	P	P	P	P	P	P
57	15E35A0107	METHUKU SAGAR REDDY	P	P	P	A	P	P	P	P	P	P
58	15E35A0108	MOHAMMED NADEEMUDDIN	P	A	P	P	P	P	P	P	P	P
59	15E35A0109	NALLA SHESHU VARDHAN REDDY	P	P	P	P	P	P	A	P	P	P
60	15E35A0110	NALLAPU VEERA HANUMANTHA RAO	P	A	P	P	P	P	P	P	P	P
61	15E35A0112	V KAVITHA	P	P	P	P	A	P	P	P	P	P
62	13E31A0102	ABDUL RAHMAN BIN HASSAN AL YAFAI	P	P	P	P	P	P	P	A	P	P
63	13E31A0105	AMBALA RAJKUMAR	P	A	P	P	P	P	P	P	P	P
64	13E31A0138	MUSKU SANTOSH	P	P	P	P	P	P	A	P	P	P
65	13E31A0113	DABBA ROHITH	P	P	P	P	P	P	P	P	A	P



Handwritten signature

PRINCIPAL
MAHAVEER
 INSTITUTE OF SCIENCE & TECHNOLOGY
 Bandlaguda, Hyd-500 005.



Technical Training Exam on STAAD ProVi8 Software
(A.Y-2016-17)

2x10=20 Marks

Answer All the Questions

- a. Analyse the given beam using Staad Pro Cross section of Beam 200mmx400mm Grade of Concrete M 25 Grade of Steel Fe 415. Plot SFD,BMD and deflected profile.

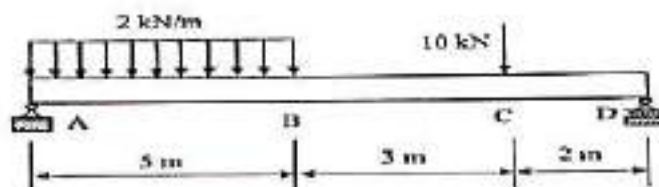

- b. Analyse the given beam using Staad Pro Cross section of Beam 200mmx400mm Grade of Concrete M 30 Grade of Steel Fe 415. Plot SFD,BMD and deflected profile.

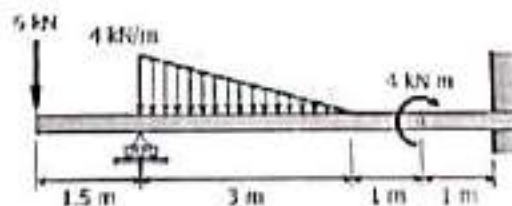

K. Subh
PRINCIPAL
MAHAVEER
INSTITUTE OF SCIENCE & TECHNOLOGY
Bandlaguda, Hyd-500 005.

- c. Analyse the given beam using Staad Pro Cross section of Beam 200mmx400mm Grade of Concrete M 25 Grade of Steel Fe 415. Plot SFD,BMD and deflected profile.

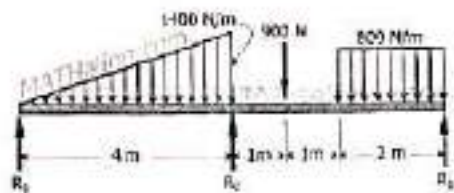

Mahaveer
PRINCIPAL
MAHAVEER
INSTITUTE OF SCIENCE & TECHNOLOGY
Kadavathur, K. J. Somayajulu Road, G.O.S.



Department of Mechanical Engineering STAAD PROVi8 Technical Training student Marks list 2017-18

Sl.NO	Roll No	Name of the student	YEAR	MARKS	PASS/I
1	14E31A0101	A SRIKANTH	IV	15	PAS:
2	14E31A0103	AMBATI NEELIMA	IV	15	PAS:
3	14E31A0104	ANKITH KUMAR TIWARI	IV	16	PAS:
4	14E31A0105	AREF ABDUR RAHMAN AL KASERI	IV	15	PAS:
5	14E31A0106	AVULA AJAYA LAKSHMI	IV	15	PAS:
6	14E31A0107	BATHARAJU ARUN KUMAR	IV	15	PAS:
7	14E31A0108	BATTHINI VINAY	IV	15	PAS:
8	14E31A0109	BEJJURI PRASHANTH	IV	16	PAS:
9	14E31A0111	BOINIPELLI SHRUTHI	IV	15	PAS:
10	14E31A0112	BUDUGULA KIRAN KUMAR	IV	14	PAS:
11	14E31A0113	CHITIKESHI OMPRAKASH	IV	18	PAS:
12	14E31A0114	EPPA OMPRAKASH	IV	15	PAS:
13	14E31A0115	FAIZAN BAIG	IV	16	PAS:
14	14E31A0116	GADDAVARI SHIVA KRISHNA	IV	16	PAS:
15	14E31A0117	GANDLA SUHRUDH	IV	15	PAS:
16	14E31A0118	GORLA SHRAVANI	IV	16	PAS:
17	14E31A0119	GOTTE TEJASWEI	IV	16	PAS:
18	14E31A0120	ISLAVATH PAVANKUMAR	IV	16	PAS:
19	14E31A0121	JADHAV SAI KRISHNA	IV	16	PAS:
20	14E31A0122	KONUGANTI NIKHIL REDDY	IV	16	PAS:
21	14E31A0123	MAJJARI CHANDRA SHEKHAR	IV	16	PAS:
22	14E31A0124	MASARATH JAHAN	IV	15	PAS:
23	14E31A0125	MEKAPOTHULA SANDEEP	IV	15	PAS:
24	14E31A0126	MIR SIDDIQ MUQTADIR ALI HASHMI	IV	15	PAS:

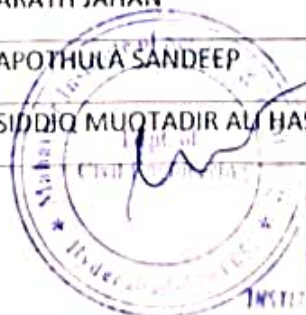

PRINCIPAL
MAHAVEER

INSTITUTE OF SCIENCE & TECHNOLOGY

011245200, Hyderabad - 500 005

25	14E31A0127	MOGILI LIKHITHA	IV	15	PASS
26	14E31A0128	MOGULAM ROHITH	IV	15	PASS
27	14E31A0129	MOHAMMED AIRAJ MOHIUDDIN	IV	15	PASS
28	14E31A0130	MOHAMMED ASIM SULEMAN	IV	15	PASS
29	14E31A0131	MOHAMMED JAWAD UDDIN	IV	16	PASS
30	14E31A0134	MOHD ABDUL RAOOF	IV	15	PASS
31	14E31A0136	MOHD IBRAHIMA FARUQE	IV	14	PASS
32	14E31A0137	MOHD MOHIUDDIN FAIZ	IV	18	PASS
33	14E31A0139	NAARSING AISHWARYA	IV	15	PASS
34	14E31A0140	NIMMALA THIRUPATHI	IV	16	PASS
35	14E31A0141	PALAM SRIKANTH REDDY	IV	16	PASS
36	14E31A0142	PERAPOGU SHASHI KIRAN	IV	15	PASS
37	14E31A0144	RAVINTHALA NARENDRA BABU	IV	16	PASS
38	14E31A0145	SAYYAD SOHEL	IV	15	PASS
39	14E31A0147	SHAIK RAHIL FARAZ	IV	14	PASS
40	14E31A0148	SILUVERI MADHUKAR	IV	18	PASS
41	14E31A0149	SOMA SRILATHA	IV	15	PASS
42	14E31A0150	SYED ISMAIL	IV	16	PASS
43	14E31A0151	SYED KALEEM ULLAH QUADRI	IV	16	PASS
44	14E31A0152	SYED MOHAMMED FIRDOUSE	IV	15	PASS
45	14E31A0153	SYED MUJSTAFI ALI	IV	16	PASS
46	14E31A0154	SYED NUMAN	IV	14	PASS
47	14E31A0155	SYED SAAD SHAREEF	IV	18	PASS
48	14E31A0157	VAISHNAVI UPADHYAY	IV	15	PASS
49	14E31A0158	VANAPARTHI SANTHOSH VARMA	IV	16	PASS
50	14E31A0159	VEMULA AVINASH	IV	15	PASS

K. S. S. S.

PRINCIPAL
MAHAVEER
INSTITUTE OF SCIENCE & TECHNOLOGY
Kandlaguda, Hyd-500 005.

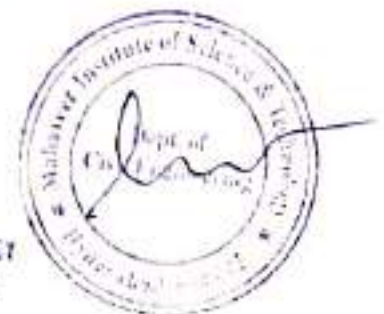

51	13E31A0102	ABDUL RAHMAN BIN HASSAN AL YAFAI	IV	15	PASS
52	15E35A0101	ALTAF AHMED	IV	16	PASS
53	15E35A0102	B SAI KRISHNA	IV	15	PASS
54	15E35A0103	BORRA RAGHU RAM	IV	14	PASS
55	15E35A0104	GANGULA RATHNA KUMAR	IV	18	PASS
56	15E35A0105	KASTHOORI VENKATAKRISHNA	IV	15	PASS
57	15E35A0106	MD JUNED	IV	16	PASS
58	15E35A0107	METHUKU SAGAR REDDY	IV	16	PASS
59	15E35A0108	MOHAMMED NADEEMUDDIN	IV	15	PASS
60	15E35A0109	NALLA SHESHU VARDHAN REDDY	IV	16	PASS
61	15E35A0110	NALLAPU VEERA HANUMANATHA RAO	IV	15	PASS
62	15E35A0112	V KAVITHA	IV	16	PASS
63	13E31A0105	AMBALA RAJKUMAR	IV	15	PASS
64	13E31A0138	MUSKU SANTOSH	IV	14	PASS
65	13E31A0113	DABBA ROHITH	IV	18	PASS

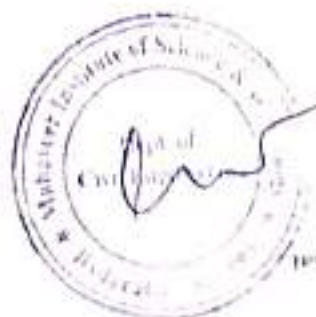

K. S. Mahaveer
PRINCIPAL
MAHAVEER

10/11/2023
 10/11/2023

Vysapuri, Bandlaguda Post:Keshavgiri,
Hyderabad-500 005, Telangana INDIA
Tel: 040-64596979,20020773, Fax: 040-24455003
E-mail: principal.mahaveer@gmail.com,
Website: www.mist.ac.in,

MAHAVEER

INSTITUTE OF SCIENCE & TECHNOLOGY
Approved by AICTE, Affiliated to JNTUH,Hyd.



STAAD PROv8 COURSE

Summery

Department of Civil Engineering

- Model Generation and Editing
- Assigning loads
- Creating Load Combinations
- Concrete Design
- Seismology
- Steel Design
- Foundation Designs
- Report Generation and Plotting

Abhishek

PRINCIPAL
MAHAVEER
INSTITUTE OF SCIENCE & TECHNOLOGY
BANDLAGUDA POST, KESHAVGIRI, HYDRABAD-500 005



Vysapuri, Bandlaguda Post:Keshavgiri,
Hyderabad-500 005, Telangana INDIA
Tel: 040-64596979,20020773, Fax: 040-24455003
E-mail: principal.mahaveer@gmail.com,
Website: www.mist.ac.in,

MAHAVEER

INSTITUTE OF SCIENCE & TECHNOLOGY

Approved by AICTE, Affiliated to JNTUH,Hyd.



CERTIFICATE OF COURSE COMPLETION

This certificate is presented to _____ of
MIST,who has successfully completed technical training course
on “STAAD PROVi8” held from _____ to _____
and found the student performance to be excellent.



ESTD : 2001

CH. SWETHAMBER

HOD

Civil department

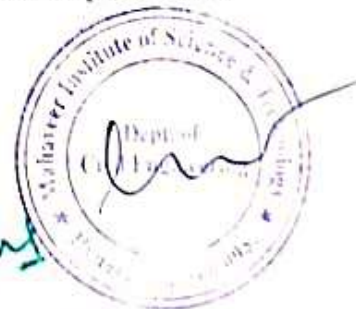

PRINCIPAL
MAHAVEER
INSTITUTE OF SCIENCE & TECHNOLOGY
Bandlaguda, Hyd-500 005.

Vysapuri, Bandlaguda Post: Keshavgi,

MAHAVEER



Hyderabad-500 005, TELANGANA INDIA

Tel: 040-64596979,8978380592 Fax: 040-24455903

E-mail: e3hod.eee@gmail.com

Website: www.mist.ac.in

Approved by AICTE, Affiliated to JNTUH,Hyd.

DEPARTMENT OF ELECTRICAL & ELECTRONICS

Date: 2-02-2018

To
The Principal,
Mist,
Hyderabad.

Sub: Proposal for Add on course-Reg.

Respected sir,

We are going to conduct two weeks workshop on **INDUSTRIAL MANAGEMENT**. We require your approval to go head for further proceeding and hope to get an opportunity to serve you the best.

With thanks and regards

R.V.Amavath
HOD-EEE

Kishor

PRINCIPAL
MAHAVEER
INSTITUTE OF SCIENCE & TECHNOLOGY
Bandlaguda, Hyd-500 005.

Professor & HOD
Dept. of Electrical & Electronics
Mahaveer Institute of Science & Technology
Vysapuri, Bandlaguda, Keshavgi,
Hyderabad - 500 005.

Vysapuri, Bandlaguda Post:Keshavpur.

MAHAVEER



Hyderabad-500 005, TELANGANA INDIA

Tel: 040-64596979,8978380692, Fax: 040-24455003

E-mail: e3hod.eee@gmail.com.

Website: www.mist.ac.in.

Approved by AICTE. Affiliated to JNTUH Hyd.

DEPARTMENT OF ELECTRICAL & ELECTRONICS

Date: 02-02-2018

CIRCULAR

Technical Trainings for II B.Tech students are starting from **13-02-2018** onwards. All HODs and placements coordinators have to manage the trainings and ensure 95% attendance all through the sessions.

All mentors need to send the compiled feedback report to HOD at e3hod.eee@gmail.com daily. Mentors are advised to take care of PNR (Students not participating in training).

Agenda: **Industrial Management**

Design & Development of Curriculum for Add on Courses Faculty Names 1. Dr R.V. AMARNATH
2. P.V.V SATYANARAYANA

PRINCIPAL
MAHAVEER
INSTITUTE OF SCIENCE & TECHNOLOGY
Bandlaguda, Hyd-500 005.

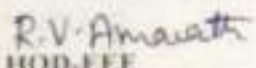
R.V. Amarnath
HOD-EEE
Professor & Head
Dept. of Electrical & Electronics Engg.
Mahaveer Institute of Science & Technology
Vysapuri, Bandlaguda, Keshavpur,
Hyderabad - 500 005.

Vysapuri, Bandlaguda Post, Keshavgi, Hyderabad-500 005, TELANGANA INDIA

MAHAVEER



Hyderabad-500 005, TELANGANA INDIA

Tel: 040-64596979, 8978380692 Fax: 040-24455003

E-mail: e3hod.eee@gmail.com

Website: www.mistac.in

Approved by AICTE. Affiliated to JNTUH, Hyd.

DEPARTMENT OF ELECTRICAL & ELECTRONICS

SYLLABUS FOR Industrial Management

SNO	TOPIC COVERED	DURATION
1	Introduction	3
2	Basics of control systems	3
3	Importance of control system	3
4	Open loop and closed loop systems	3
5	Components of control system	3
6	Different input buttons	3
7	Electrical actuators and controller	3
8	Block diagram reduction techniques	3
9	Working of Potentiometer	3
10	Control procedure in Control system	3

R.V. Amrath
HOD-EEE

Professor & Head

Dept. of Electrical & Electronics

Mahaveer Institute of Science & Technology

Vysapuri, Bandlaguda, Keshavgi,

Hyderabad - 500 005.

Principal
PRINCIPAL
MAHAVEER
INSTITUTE OF SCIENCE & TECHNOLOGY
Bandlaguda, Hyd-500 005.

Vysapuri, Bandlaguda Post: Keshavgiri,

MAHAVEER



Hyderabad-500 005, TELANGANA INDIA

Tel: 040-64596979, 8978380692 Fax: 040-24455003

E-mail: e3hod_eee@gmail.com,

Website: www.mist.ac.in,

Approved by AICTE. Affiliated to JNTUH, Hyd

DEPARTMENT OF ELECTRICAL & ELECTRONICS

LIST OF REGISTERED STUDENTS FOR Industrial Management

SNO	HALL TICKET NO	NAME OF THE STUDENT
1	16E31A0201	ABDUL RAHEMAN
2	16E31A0202	AKKALADEVI RAMYASRI
3	16E31A0203	ARUKONDA MANIDEEP
4	16E31A0204	BANOTH PRAVEENKUMAR
5	16E31A0205	BEJAWADA SANDEEP
6	16E31A0206	BYRA NAGARANI
7	16E31A0207	DESHWAL VINEET
8	16E31A0208	EEGA PRACHYUTH
9	16E31A0209	GUDAPATI VEENA
10	16E31A0210	JADAV SATHISH
11	16E31A0211	JYESTA RAJESWARI
12	16E31A0212	K VEERESH
13	16E31A0213	KARLA GNANAPRASUNA
14	16E31A0214	MANDADI SOUNDARYA
15	16E31A0215	MANNE SRIDHAR
16	16E31A0216	MAVILLA KAGHAVENDER GOUD
17	16E31A0217	MD DANISH PERWEZ
18	16E31A0218	MEGAVATH PAVAN KUMAR
19	16E31A0219	MITTAPELLY MAHESH
20	16E31A0221	MS MANSI DUBEY
21	16E31A0222	MUTHINENI VAMSHI
22	16E31A0223	PINREDDY AJITH REDDY
23	16E31A0224	PITTALA PAVAN KALYAN
24	16E31A0225	PUNNA VAISHNAVI
25	16E31A0226	RATAPU VIJAY
26	16E31A0227	RENDLA RANITH
27	16E31A0228	ROSHAN PATNAIK
28	16E31A0229	SANABOINA KRISHNAVAMSI
29	16E31A0230	SHIRAM SHETTY SAI KUMAR
30	16E31A0231	UPPUNUTALA ARUN KUMAR

Kishu
PRINCIPAL
MAHAVEER
INSTITUTE OF SCIENCE & TECHNOLOGY
Bandlaguda, Hyd-500 005.

R. V. Ramakrishna
Professor & Head
Dept. of Electrical & Electronics Engg
Mahaveer Institute of Science & Technology
Vysapuri, Bandlaguda, Keshavgiri,
Hyderabad - 500 005.

Vysapuri, Bandlaguda Post, Keshavnagar

MAHAVEER



Hyderabad-500 005, TELANGANA INDIA

Tel: 040-64596979, 8978380692 Fax: 040-24455003

Approved by AICTE, Affiliated to JNTUH, Hyd

E-mail: e3hod_eee@gmail.com

Website: www.mist.ac.in

DEPARTMENT OF ELECTRICAL & ELECTRONICS

RESULT SHEET FOR Industrial Management REGISTERED STUDENTS

SNO	HALL TICKET NO	NAME OF THE STUDENT	MARKS (20)	RESULT
1	16E31A0201	ABDUL RAHEMAN	20	PASS
2	16E31A0202	AKKALADEVI RAMYASRI	19	PASS
3	16E31A0203	ARUKONDA MANIDHEP	20	PASS
4	16E31A0204	BANOTH PRAVEENKUMAR	18	PASS
5	16E31A0205	BEJAWADA SANDEEP	20	PASS
6	16E31A0206	BYRA NAGARANI	20	PASS
7	16E31A0207	DESHWAL VINEET	16	PASS
8	16E31A0208	EEGA PRACHYUTH	20	PASS
9	16E31A0209	GUDAPATI VEENA	20	PASS
10	16E31A0210	JADAV SATHISH	17	PASS
11	16E31A0211	JYESTA RAJESWARI	20	PASS
12	16E31A0212	K VEERESH	20	PASS
13	16E31A0213	KARLA GNANAPRASUNA	16	PASS
14	16E31A0214	MANDADI SOUNDARYA	20	PASS
15	16E31A0215	MANNE SRIDHAR	20	PASS
16	16E31A0216	MAVILLA RAGHAVENDER GOUD	18	PASS
17	16E31A0217	MD DANISH PERWEZ	20	PASS
18	16E31A0218	MEGAVATH PAVAN KUMAR	19	PASS
19	16E31A0219	MITTAPELLY MAHESH	20	PASS
20	16E31A0221	MS MANSHI DUBEY	18	PASS
21	16E31A0222	MR. CHANDEN VAMSHI	20	PASS
22	16E31A0223	PINREDDY VITHI REDDY	20	PASS
23	16E31A0224	PITTALA PAVAN KALYAN	16	PASS
24	16E31A0225	PUNNA VAISHNAVI	20	PASS
25	16E31A0226	RAJARAPU VJAY	19	PASS
26	16E31A0227	RENDA RANJITH	20	PASS
27	16E31A0228	ROSHAN PATNAIK	18	PASS
28	16E31A0229	SANABOINA KRISHNAVAMSI	20	PASS
29	16E31A0230	SHIRAM SHETTY SAI KUMAR	20	PASS
30	16E31A0231	UPPUNUTALA ARUN KUMAR	16	PASS

Kalyan MUNICIPAL
MAHAVEER
INSTITUTE OF SCIENCE & TECHNOLOGY
Bandlaguda, Hyd-500 005.

Vysapuri, Bandlaguda Post:Keshavgin,

MAHAVEER



Hyderabad-500 005, TELANGANA INDIA

Tel: 040-64596979,8978380692 Fax: 040-24455003

E-mail: e3hod.eee@gmail.com,

Website: www.mist.ac.in,

Approved by AICTE. Affiliated to JNTUH,Hyd.

DEPARTMENT OF ELECTRICAL & ELECTRONICS

No. of students Registered:30

No. of students Passed:30

No. of students failed:NIL.

R.V.Amaethu

PROFESSOR & HEAD

Dept. of Electrical & Electronics Engg
Mahaveer Institute of Science & Technology
Vysapuri, Bandlaguda, Keshavgin,
Hyderabad - 500 005.

K. Subh

PRINCIPAL
MAHAVEER
INSTITUTE OF SCIENCE & TECHNOLOGY
Bandlaguda, Hyd-500 005.

Vysapuri, Bandlaguda Post: Keshavpur,

MAHAVEER



Hyderabad-500 005, TELANGANA INDIA

Tel: 040-64556979, 8978380692 Fax: 040-24455603

E-mail: e3hod.eee@gmail.com

Website: www.mist.ac.in

Approved by AICTE, Affiliated to JNTU(H)Hyd

DEPARTMENT OF ELECTRICAL & ELECTRONICS

Industrial Management QUESTION PAPER

Duration: 120 Minutes

4 X 5 = 20 Marks

Answer the following all questions. Each question carries 5 marks.

1. What is the main objective of Industrial Management?
2. What are the Responsibility of a Production Manager?
3. Explain shutdown maintenance and predictive maintenance?
4. Explain preventive maintenance and corrective maintenance ?

K. V. Amavath
PRINCIPAL
MAHAVEER
INSTITUTE OF SCIENCE & TECHNOLOGY
Bandlaguda, Hyd-500 005.

R. V. Amavath
HOD-EEE

Professor & Head
Dept. of Electrical & Electronics Engg
Mahaveer Institute of Science & Technology
Vysapuri, Bandlaguda, Keshavpur,
Hyderabad - 500 005.

Vysapuri, Bandlaguda Post:Keshavgiri,

MAHAVEER



Hyderabad-500 005, TELANGANA INDIA

Tel: 040-64596979,8978380692,Fax: 040-24455063

E-mail: e3hod.eee@gmail.com,

Website: www.mist.ac.in,

Approved by AICTE. Affiliated to JNTUH.Hyd

DEPARTMENT OF ELECTRICAL & ELECTRONICS

SUMMARY REPORT OF Industrial Management

Industrial management is the organizational process that includes **strategic planning, setting objectives, managing resources, deploying the human and financial assets needed to achieve objectives, and measuring results.**

COORDINATOR

Copy to:

1. Department Notice Board
2. Principal for Information
3. Committee Members (Academic)

PRINCIPAL
MAHAVEER
INSTITUTE OF SCIENCE & TECHNOLOGY
Bandlaguda, Hyd-500 005.

MAHAVEER INSTITUTE OF SCIENCE AND TECHNOLOGY



(Affiliated to JNTUH, Hyderabad and Approved by AICTE, New Delhi)
Vyasapuri, Bandlaguda, Post: Keshavagiri, Hyderabad- 500005

organized by

Department of Electrical and Electronics Engineering

CERTIFICATE

This is certify that Rajarapu Vijay bearing Hall Ticket No 16E31A029
B.Tech Second Year has Participated in Industrial management Training
Program From 13-02-2018 to 26-02-2018 organized by Department
Electrical and Electronics Engineering.

HOD

Dr.R.V.Amarnath

Dr.M.Rajendar Reddy

VITS

PRINCIPAL

Dr.K.S.S.S.M

A
Two week certificate course
on
Industrial Management
(14th Feb-01st Mar 2018)
Timings: 09.30 am to 11.30 am



Organized by



Dept. Of Electrical & Electronics Engineering
Mahaveer Institute of Science & Technology
Vyasapuri, Bandlaguda, Hyderabad 500005.
(Affiliated to JNTUJH)

About the College

As an Institute committed to quality education MIST aims at providing learning with a technology edge. Right from its inception in 2001, it has turning itself to meet this objective. It endeavors to provide consistent training to the students to help them evolve as competent professionals in the highly competitive world.

About the Department

The Department of **Electrical & Electronics Engineering** was established in 2001 which offers **B.Tech, and M.Tech (POWER Engineering and Energy Systems)** courses with highly qualified, dedicated and motivated faculty. The courses and programmes offered by the department not only impart technical expertise to the students but also gives a professional experience.

Organizing committee

Chief Patrons

Smt. S Sudershan Reddy, Chairman, MIST
Sri S. Surendar Reddy, Secretary, MIST

Patron

Dr.KSSSN Reddy, Principal, MIST

Convener

Dr.R.V Anamath, Professor, HoD EEE Dept

Co-convener

Mr G.Prem Kumar Reddy, Associate Prof. EEE

Program Coordinators

Mr. B.SATISH Assistant Professor, EEE
Mrs.N SARASWATHI Assistant Professor, EEE
Mr A.MAHESH Assistant Professor, EEE
Mr T Ravi Babu Assistant Professor, EEE
Mr P.Phanindra, Assistant Professor, EEE
Mr G.Hathiram, Assistant Professor, EEE
Mr B.Srinivasulu, Assistant Professor, EEE

Course Details

- Introduction
- Basics of control systems
- Importance of control system system.
- Open loop and closed loop systems
- Components of control system
- Electrical actuators and controller
- Control procedure in Control system

Resource Person

Dr.M.Rajendar Reddy, VITS

Objectives of Workshop

Industrial management is the organizational process that includes strategic planning, setting, objectives, managing resources, deploying the human and financial assets needed to achieve objectives, and measuring results

Who can Participate

Students and Faculty members of various Universities, Colleges and Industries.

Contact details

Feel free to ask your queries either by E-Mail: e3hod.eee@gmail.com, (or) 8919959541
Contact – 8309846628, 8985906696.

Venue:

Main Seminar Hall

Mahaveer Institute of Science &
Technology

Vyasapuri, Bandlaguda, Post: Keshavagiri,
Hyderabad- 500005, Telangana, India

Vysapuri, Bandlaguda Post:Keshavgi,

MAHAVEER



Hyderabad-500 005, TELANGANA INDIA

Tel: 040-64596979,8978380692,Fax: 040-24455003

E-mail: ejhod.eee@gmail.com,

Website: www.mist.ac.in,

INSTITUTE OF SCIENCE & TECHNOLOGY

Approved by AICTE, Affiliated to JNTUH,Hyd.

DEPARTMENT OF ELECTRICAL & ELECTRONICS

Date: 02-09-2017

To
The Principal,
Mist,
Hyderabad.

Sub:Proposal for Add on course-Reg.

Respected sir,

We are going to conduct two weeks workshop on **ELECTRICAL INSTALLATION STANDARDS**. We require your approval to go head for further proceeding and hope to get an opportunity to serve you the best.

With thanks and regards

R.V.Amaeth

HOD-EEE

Professor & Head

Dept. of Electrical & Electronics En-
gineering, Institute of Science & Technology
Vysapuri, Bandlaguda, Keshavgi,
Hyderabad - 500 005.

Kishu
PRINCIPAL
MAHAVEER
INSTITUTE OF SCIENCE & TECHNOLOGY
Bandlaguda, Hyd-500 005.
Bandlaguda, Hyd-500 005.

Vysapuri, Bandlaguda Post:Keshavgiri,

MAHAVEER



Hyderabad-500 005, TELANGANA INDIA

Tel: 040-64596979,8978380692,Fax: 040-24455903

E-mail: e3hod.eee@gmail.com,

Website: www.mist.ac.in,

Approved by AICTE, Affiliated to JNTUH,Hyd.

DEPARTMENT OF ELECTRICAL & ELECTRONICS

Date: 02-09-2017

CIRCULAR

Technical Trainings for III B. Tech students are starting from 12-09-2017 onwards. All HODs and placements coordinators have to manage the trainings and ensure 95% attendance all through the sessions.

All mentors need to send the compiled feedback report to HOD at e3hod.eee@gmail.com daily. Mentors are advised to take care of PNR (Students not participating in training).

Agenda: **Electrical Installation Standards**

Design & Development of Curriculum for Add on Course Faculty Names 1. Dr Rv Amarnath

2. G Prem kumar reddy

K. Srinivas
PRINCIPAL
MAHAVEER
INSTITUTE OF SCIENCE & TECHNOLOGY
Bandlaguda, Hyd-500 005.

R.V. Amarnath
HOD-EEE
Professor & Head
Dept. of Electrical & Electronics Engg
Mahaveer Institute of Science & Technology
Vysapuri, Bandlaguda, Keshavgiri,
Hyderabad - 500 005.

Vysapuri, Bandlaguda Post:Keshavgiri,

MAHAVEER



Hyderabad-500 005, TELANGANA INDIA

Tel: 040-64596979,0978380692,Fax: 040-24455003

E-mail: e3hcd.eee@gmail.com,

Website: www.mist.ac.in,

Approved by AICTE, Affiliated to JNTUH,Hyd.

DEPARTMENT OF ELECTRICAL & ELECTRONICS

SYLLABUS FOR Electrical Installation Standards

SNO	TOPIC COVERED	DURATION
1	<i>Introduction</i>	3
2	<i>Electric shock</i>	3
3	<i>Exposed metals</i>	3
4	<i>Fuses</i>	3
5	<i>Circuit breaker</i>	3
6	<i>Boiler</i>	3
7	<i>Turbine</i>	3
8	<i>Alternator</i>	3
9	<i>Pulvarization</i>	3
10	<i>Working of tps</i>	3

PRINCIPAL
MAHAVEER
INSTITUTE OF SCIENCE & TECHNOLOGY
Bandlaguda, Hyd-500 005.

R.V. Amruth
HOD-EEE

Professor & Head
Dept. of Electrical & Electronics Engg
Mahaveer Institute of Science & Technology
Vysapuri, Bandlaguda, Keshavgiri,
Hyderabad - 500 005.

Vysapuri, Bandlaguda Post:Keshavgiri,

MAHAVEER



Hyderabad-500 005, TELANGANA INDIA

Tel: 040-64596979,8978380692,Fax: 040-24455003

E-mail: e3hod.eee@gmail.com,

Website: www.mist.ac.in,

Approved by AICTE, Affiliated to JNTUH,Hyd.

DEPARTMENT OF ELECTRICAL & ELECTRONICS

LIST OF REGISTERED STUDENTS FOR Electrical Installation Standards

SNO	HALL TICKET NO	NAME OF THE STUDENT
1	15E31A0201	ADARI UMASHANKAR
2	15E31A0203	ARRUM VAMSHIKRISHNA
3	15E31A0205	B AKHILA
4	15E31A0206	BALLE ARAVIND KUMAR
5	15E31A0207	BANOTH BALAJI
6	15E31A0208	BHUKYA PRAVALIKA
7	15E31A0209	BURRA HARISH
8	15E31A0210	CHEVITI VINAY KUMAR
9	15E31A0211	GANDI SAI KIRAN
10	15E31A0213	GUDA AVINASH
11	15E31A0216	KASIREDDY SAI KIRAN REDDY
12	15E31A0217	KATAKAM ANUDEEP KUMAR
13	15E31A0218	KAVYA N
14	15E31A0219	KOKKULA SAIKIRAN
15	15E31A0220	KOONARAPU AKHIL
16	15E31A0221	KUCHOOR PRANEETHDEEP REDDY
17	15E31A0222	KUSUNOJU MADHU
18	15E31A0224	NADDIPALLI KANCHANA
19	15E31A0225	NAKIDI ABHISHEK
20	15E31A0226	NERLAKANTI NANDUVARDHAN REDDY
21	15E31A0227	RATHOD AMBADAS
22	15E31A0228	SHIVANNAGARI BHASKARREDDY
23	15E31A0229	SHIVANNA SAI VASRI
24	15E31A0230	SODI SRIKRISHNA
25	15E31A0231	THONGALA SHINEY
26	15E31A0232	VOGULAPU RAJESH
27	15E31A0233	YARUKALA SAI PRAKASH
28	15E31A0234	J RAVI TEJA
29	16E35A0201	ALETI NISHITA
30	16E35A0202	ERRALLA DEEPAK
31	16E35A0203	JAKANAPALLY SHIRISHA
32	16E35A0204	JALLA ANJANEYULU
33	16E35A0205	KRISHNATEJA ALETI
34	16E35A0206	PEDDA GOLLA SHIRISHA YADAV
35	16E35A0207	PURI NARSING

K. Srinivas

PRINCIPAL
MAHAVEER
INSTITUTE OF SCIENCE & TECHNOLOGY
Bandlaguda, Hyd-500 005.

Vysapuri, Bandlaguda Post:Keshavgiri,

MAHAVEER



Hyderabad-500 005, TELANGANA INDIA

Tel: 040-64596979,8978380692 Fax: 040-24455903

E-mail: e3hod.eee@gmail.com,

Website: www.mist.ac.in,

Approved by AICTE, Affiliated to JNTUH,Hyd.

DEPARTMENT OF ELECTRICAL & ELECTRONICS

36	16E35A0208	RAVULA PAVAN KUMAR
37	16E35A0209	SURYA SRAVANTHI
38	16E35A0210	VANGALA RANEETH KUMAR
39	16E35A0211	YALAGANDULA DURGA DEVI

R.V. Amath

Professor & Head

Dept. of Electrical & Electronics
Mahaveer Institute of Science & Technology
Vysapuri, Bandlaguda, Keshavgiri
Hyderabad - 500 005.

K. S. S. S.

PRINCIPAL
MAHAVEER
INSTITUTE OF SCIENCE & TECHNOLOGY
Bandlaguda, Hyd-500 005.

Vysapuri, Bandlaguda Post:Keshavgi,

MAHAVEER



Hyderabad-500 005, TELANGANA INDIA

Tel: 040-64596979,8978380692,Fax: 040-24455003

E-mail: e3hod.eee@gmail.com,

Website: www.mist.ac.in,

Approved by AICTE. Affiliated to JNTUH,Hyd.

DEPARTMENT OF ELECTRICAL & ELECTRONICS

Electrical Installation Standards QUESTION PAPER

Duration: 120 Minutes

4 X5 = 20 Marks

Answer the following all questions. Each question carries 5 marks.

- Q1.Explain electric shock?
- Q2.Explain all exposed metals in electrical circuit?
- Q3. Explain process electricity made in power plant?
- Q4. Explain difference between fuse and circuit breaker?

K. Srinivas

MAHAVEER
INSTITUTE OF SCIENCE & TECHNOLOGY
Bandlaguda, Hyd-500 005,

R.V. Amaraath
HOD-EEE

Professor & Head
Dept. of Electrical & Electronic Engg
Mahaveer Institute of Science & Tech
Vysapuri, Bandlaguda, Keshavgi,
Hyderabad - 500 005.

**DEPARTMENT OF ELECTRICAL & ELECTRONICS****RESULT SHEET FOR Electrical Installation Standards REGISTERED STUDENTS**

SNO	HALL TICKET NO	NAME OF THE STUDENT	MARKS (20)	RESULT
1	15E31A0201	ADARI UMASHANKAR	20	PASS
2	15E31A0203	ARRUM VAMSHIKRISHNA	19	PASS
3	15E31A0205	B AKHILA	20	PASS
4	15E31A0206	BALLE ARAVIND KUMAR	18	PASS
5	15E31A0207	BANOTH BALAJI	20	PASS
6	15E31A0208	BHUKYA PRAVALIKA	20	PASS
7	15E31A0209	BURRA HARISH	16	PASS
8	15E31A0210	CHEVITI VINAY KUMAR	20	PASS
9	15E31A0211	GANDI SAI KIRAN	20	PASS
10	15E31A0213	GUDA AVINASH	17	PASS
11	15E31A0216	KASIREDDY SAI KIRAN REDDY	20	PASS
12	15E31A0217	KATAKAM ANUDEEP KUMAR	20	PASS
13	15E31A0218	KAVYA N	16	PASS
14	15E31A0219	KOKKULA SAIKIRAN	20	PASS
15	15E31A0220	KOONARAPU AKHIL	20	PASS
16	15E31A0221	KUCHOOR PRANEETHDEEP REDDY	18	PASS
17	15E31A0222	KUSUNOJU MADHU	20	PASS
18	15E31A0224	NADDIPALLI KANCHANA	19	PASS
19	15E31A0225	NAKIDI ABHISHEK	20	PASS
20	15E31A0226	NERI ANANTI NANDIVARDHAN REDDY	18	PASS
21	15E31A0227	RATHOD AMBADAS	20	PASS
22	15E31A0228	SHIVANNAGARI BHASKARREDDY	19	PASS
23	15E31A0229	SILUSANI NAVYASRI	20	PASS
24	15E31A0230	SODI SRIKRISHNA	18	PASS
25	15E31A0231	THONGALA SHINEY	20	PASS
26	15E31A0232	VOGULAPU RAJESH	20	PASS
27	15E31A0233	YARUKALA SAI PRAKASH	16	PASS
28	15E31A0234	J RAVI TEJA	20	PASS
29	16E35A0201	ALETI NISHITA	20	PASS
30	16E35A0202	ERRALLA DEEPAK	17	PASS

K. Srinivas PRINCIPAL
MAHAVEER

INSTITUTE OF SCIENCE & TECHNOLOGY
Bandlaguda, Hyd-500 005.

Vysapuri, Bandlaguda Post:Keshavgiri,

MAHAVEER



Hyderabad-500 005, TELANGANA INDIA

Tel: 040-64596979,8978380692,Fax: 040-24455903

E-mail: e3hod.eee@gmail.com,

Website: www.mist.ac.in,

Approved by AICTE, Affiliated to JNTUH,Hyd.

DEPARTMENT OF ELECTRICAL & ELECTRONICS

31	16E35A0203	JAKANAPALLY SHIRISHA	20	PASS
32	16E35A0204	JALLA ANJANEYULU	20	PASS
33	16E35A0205	KRISHNATEJA ALETI	16	PASS
34	16E35A0206	PEDDA GOLLA SHIRISHA YADAV	20	PASS
35	16E35A0207	PURI NARSING	20	PASS
36	16E35A0208	RAVULA PAVAN KUMAR	18	PASS
37	16E35A0209	SURYA SRAVANTHI	20	PASS
38	16E35A0210	VANGALA RANEETH KUMAR	19	PASS
39	16E35A0211	YALAGANDULA DURGA DEVI	20	PASS

No. of students Registered: 39

No. of students Passed: 39

No. of students failed: NIL

R.V. Aravind

Professor & Head

Dept. of Electrical & Electronics Engg
Mahaveer Institute of Science & Technology
Vysapuri, Bandlaguda, Keshavgiri,
Hyderabad - 500 005.

K. Srinivas

PRINCIPAL
MAHAVEER
INSTITUTE OF SCIENCE & TECHNOLOGY
Bandlaguda, Hyd-500 005.

Vysapuri, Bandlaguda Post:Keshavgi,

MAHAVEER



Hyderabad-500 005, TELANGANA INDIA

Tel: 040-64596979,8978380692,Fax: 040-24455003

E-mail: e3hod.eee@gmail.com,

Website: www.mist.ac.in,

Approved by AICTE, Affiliated to JNTUH,Hyd.

DEPARTMENT OF ELECTRICAL & ELECTRONICS

SUMMARY REPORT OF Electrical Installation Standards

The study of a proposed electrical installation requires an adequate understanding of all governing rules and regulations. A list of most common IEC standards is provided.

The total power demand can be calculated based on the location and power of each load, together with the knowledge of the operating modes (steady state demand, starting conditions, non simultaneous operation, etc.).

The power and number of sources required to supply the electrical installation is readily obtained, also taking into account local tariff structures, to allow the best choice of connection arrangement to the power-supply network, e.g. at medium voltage or low voltage level.

COORDINATOR

Copy to:

1. Department Notice Board
2. Principal for Information
3. Committee Members (Academic)



PRINCIPAL
MAHAVEER
INSTITUTE OF SCIENCE & TECHNOLOGY
Bandlaguda, Hyd-500 005.

*A Two week Certificate Course
On*

“Electrical Installation standards”
(12th - 28th sep 2017)

REGISTRATION FORM

Full Name:

Designation:

Organization:

Experience (in years):

Industry:..... Teaching:.....

Research:.....

Correspondence

Address:.....

.....

.....

E-mail id for communication (must):

.....

Ph:

Sign of Applicant:

Signature of
Head of the Institution with official Seal

Important Dates

Last date of Receiving Applications: 10.12.2017

Intimation to the selected participants: 11.12.2017

General Information:

- > Tea, snacks and lunch will be served.
- > Certificates will be issued to all the participants.
- > Transportation will be provided from city to college.
- > Limited accommodation will be provided on request from participants.

About the College:

An Institute committed to quality education MIST aims at providing learning with a technology edge. Right from its inception in 2001, it has turning itself to meet this objective. It endeavors to provide consistent training to the students to help them evolve as competent professionals in the highly competitive world.

About the Department:

The Department of E.E.E is working with a mission to contribute through excellence in technical education, with research orientation. It imparts ethical & moral values to the student's so as to make them emerge as responsible professionals. With its experienced faculty members having excellent academic backgrounds, it trains students supplementing classroom lectures with computer aided demonstrations making their learning a rich and rewarding experience.

Contact Details:

Co-ordinator

Dr.R.V.Amarnath

Head EEE Dept,MIST

Co-convenor

Mr.G. Prem Kumar Reddy,

Assoc.Prof., EEE Dept,MIST

College Numbers: Tel: 04065810046,8979380692,

Email: e3hod.eee@gmail.com,

*A Two week Certificate Course
On*

“Electrical Installation standards”
(12th - 28th sep 2017)



Organizing Secretary

Chief Patrons

Sri. S.Sudershan Reddy, Chairman, MIST

Sri. S. Suendar Reddy, Secretary, MIST

Sri S. Dhanurjay Reddy, Joint Secretary, MIST

Patron

Dr.KSSSN Reddy, Principal, MIST

Organized by



**Department of Electrical & Electronics
Engineering**

Mahaveer Institute of Science & Technology
Vyusapuri, Bandlaguda, Hyderabad 500005.
(Affiliated to JNTUH)

Electrical Installation Standards(3-1)			1	2	3	4	5	6	7	8	9	10	11	12	13	14	15	16	17	18	19	20	21	22	23	24	25	26	27	28	29	30
1	15E31A0201	ADARI UMASHANKAR	P	P	P	P	P	P	P	P	P	P	P	P	P	P	P	P	P	P	P	P	P	P	P	P	P	P	P	P	P	P
2	15E31A0203	ARRUM VAMSHIKRISHNA	P	P	P	P	P	P	P	P	P	P	P	P	P	P	P	P	P	P	P	P	P	P	P	P	P	P	P	P	P	P
3	15E31A0205	B AKHILA	P	P	P	P	P	P	P	P	P	P	P	P	P	P	P	P	P	P	P	P	P	P	P	P	P	P	P	P	P	P
4	15E31A0206	BALLE ARAVIND KUMAR	P	P	P	P	P	P	P	P	P	P	P	P	P	P	P	P	P	P	P	P	P	P	P	P	P	P	P	P	P	P
5	15E31A0207	BANGTH BALAJI	P	P	P	P	P	P	P	P	P	P	P	P	P	P	P	P	P	P	P	P	P	P	P	P	P	P	P	P	P	P
6	15E31A0208	BHUKYA PRAVALIKA	P	P	P	P	P	P	P	P	P	P	P	P	P	P	P	P	P	P	P	P	P	P	P	P	P	P	P	P	P	P
7	15E31A0209	BURRA HARISH	P	P	P	P	P	P	P	P	P	P	P	P	P	P	P	P	P	P	P	P	P	P	P	P	P	P	P	P	P	P
8	15E31A0210	CHEVITI VINAY KUMAR	P	P	P	P	P	P	P	P	P	P	P	P	P	P	P	P	P	P	P	P	P	P	P	P	P	P	P	P	P	P
9	15E31A0211	GANDI SAI KIRAN	P	P	P	P	P	P	P	P	P	P	P	P	P	P	P	P	P	P	P	P	P	P	P	P	P	P	P	P	P	P
10	15E31A0213	GUDA AVINASH	P	P	P	P	P	P	P	P	P	P	P	P	P	P	P	P	P	P	P	P	P	P	P	P	P	P	P	P	P	P
11	15E31A0216	KASHREDDY SAI KIRAN REDDY	P	P	P	P	P	P	P	P	P	P	P	P	P	P	P	P	P	P	P	P	P	P	P	P	P	P	P	P	P	P
12	15E31A0217	KATAKAM ANUDEEP KUMAR	P	P	P	P	P	P	P	P	P	P	P	P	P	P	P	P	P	P	P	P	P	P	P	P	P	P	P	P	P	P
13	15E31A0218	KAVYA N	P	P	P	P	P	P	P	P	P	P	P	P	P	P	P	P	P	P	P	P	P	P	P	P	P	P	P	P	P	P
14	15E31A0219	KOKKULA SAIKIRAN	P	P	P	P	P	P	P	P	P	P	P	P	P	P	P	P	P	P	P	P	P	P	P	P	P	P	P	P	P	P
15	15E31A0221	KUCHOOR PRANEETH DEEP	P	P	P	P	P	P	P	P	P	P	P	P	P	P	P	P	P	P	P	P	P	P	P	P	P	P	P	P	P	P
16	15E31A0222	KUSUNOJU MADHU	P	P	P	P	P	P	P	P	P	P	P	P	P	P	P	P	P	P	P	P	P	P	P	P	P	P	P	P	P	P
17	15E31A0224	NADDIPALLI KANCHANA	P	P	P	P	P	P	P	P	P	P	P	P	P	P	P	P	P	P	P	P	P	P	P	P	P	P	P	P	P	P
18	15E31A0225	NAKIDI ABHISHEK	P	P	P	P	P	P	P	P	P	P	P	P	P	P	P	P	P	P	P	P	P	P	P	P	P	P	P	P	P	P
19	15E31A0228	SHIVANNAGARI BILASKAR	P	P	P	P	P	P	P	P	P	P	P	P	P	P	P	P	P	P	P	P	P	P	P	P	P	P	P	P	P	P
20	15E31A0229	SILUSANI NAVYASRI	P	P	P	P	P	P	P	P	P	P	P	P	P	P	P	P	P	P	P	P	P	P	P	P	P	P	P	P	P	P
21	15E31A0230	SODI SRIKRISHNA	P	P	P	P	P	P	P	P	P	P	P	P	P	P	P	P	P	P	P	P	P	P	P	P	P	P	P	P	P	P
22	15E31A0231	THONGALA SHINEY	P	P	P	P	P	P	P	P	P	P	P	P	P	P	P	P	P	P	P	P	P	P	P	P	P	P	P	P	P	P
23	15E31A0233	YARUKALA SAI PRAKASH	P	P	P	P	P	P	P	P	P	P	P	P	P	P	P	P	P	P	P	P	P	P	P	P	P	P	P	P	P	P
24	15E31A0234	J RAVI TEJA	P	P	P	P	P	P	P	P	P	P	P	P	P	P	P	P	P	P	P	P	P	P	P	P	P	P	P	P	P	P
25	16E35A0201	ALETI NISHITA	P	P	P	P	P	P	P	P	P	P	P	P	P	P	P	P	P	P	P	P	P	P	P	P	P	P	P	P	P	P
26	16E35A0203	JAKANAPALLY SHIRISHA	P	P	P	P	P	P	P	P	P	P	P	P	P	P	P	P	P	P	P	P	P	P	P	P	P	P	P	P	P	P
27	16E35A0204	JALLA ANJANEYULU	P	P	P	P	P	P	P	P	P	P	P	P	P	P	P	P	P	P	P	P	P	P	P	P	P	P	P	P	P	P
28	16E35A0205	KRISHNATEJA ALETI	P	P	P	P	P	P	P	P	P	P	P	P	P	P	P	P	P	P	P	P	P	P	P	P	P	P	P	P	P	P
29	16E35A0206	PEDDA GOLLA SHIRISHA YAMMAM	P	P	P	P	P	P	P	P	P	P	P	P	P	P	P	P	P	P	P	P	P	P	P	P	P	P	P	P	P	P
30	16E35A0207	PURI NARSING	P	P	P	P	P	P	P	P	P	P	P	P	P	P	P	P	P	P	P	P	P	P	P	P	P	P	P	P	P	P
31	16E35A0208	RAVULA PAVAN KUMAR	P	P	P	P	P	P	P	P	P	P	P	P	P	P	P	P	P	P	P	P	P	P	P	P	P	P	P	P	P	P
32	16E35A0209	SURYA SRAVANTHI	P	P	P	P	P	P	P	P	P	P	P	P	P	P	P	P	P	P	P	P	P	P	P	P	P	P	P	P	P	P
33	16E35A0210	VANGALA RANEETH KUMAR	P	P	P	P	P	P	P	P	P	P	P	P	P	P	P	P	P	P	P	P	P	P	P	P	P	P	P	P	P	P
34	16E35A0211	YALAGANDULA DURGA DEVI	P	P	P	P	P	P	P	P	P	P	P	P	P	P	P	P	P	P	P	P	P	P	P	P	P	P	P	P	P	P
35	14E31A0206	B VENKATESH	P	P	P	P	P	P	P	P	P	P	P	P	P	P	P	P	P	P	P	P	P	P	P	P	P	P	P	P	P	P
36	14E31A0208	D DEVA RAJU	P	P	P	P	P	P	P	P	P	P	P	P	P	P	P	P	P	P	P	P	P	P	P	P	P	P	P	P	P	P
37	14E31A0209	DOMMATA BHASKAR	P	P	P	P	P	P	P	P	P	P	P	P	P	P	P	P	P	P	P	P	P	P	P	P	P	P	P	P	P	P
		Signature of the Faculty	P	P	P	P	P	P	P	P	P	P	P	P	P	P	P	P	P	P	P	P	P	P	P	P	P	P	P	P	P	P

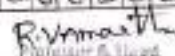
 R. V. M. Reddy
 Professor & Head
 Dept. of Electrical & Electronics
 J. Jayaram Institute of Science & Tech.
 Vyasaपुरi, Bandlaguda, Keshavnagar,
 Hyderabad - 500 005.

MAHAVEER INSTITUTE OF SCIENCE AND TECHNOLOGY

(Affiliated to JNTUHH, Hyderabad and Approved by AICTE, New Delhi)
Vyasapuri, Bandlaguda, Post: Keshavagiri, Hyderabad- 500005



organized by

Department of Electrical and Electronics Engineering

CERTIFICATE

This is certify that **B.Harish** bearing Hall Ticket No **15E31A0209** of **B.Te**
Third Year has Participated in **Electrical Installation Standards Training**
Program From **12-09-2017** to **25-09-2017** organized by **Department of**
Electrical and Electronics Engineering.

HOD
Dr.R.V.Amarnath

Dr.M.Rajendar Reddy
VITS

PRINCIPAL
Dr.K.S.S.S.N.R

PRINCIPAL
MAHAVEER
INSTITUTE OF SCIENCE & TECHNOLOGY
Bandlaguda, Hyd-500 005.

About the College

As an Institute committed in quality education, MIST aims at providing learning with a Technology-edge. It endeavors to provide consistent training to its students to help them evolve as competent professionals in the highly competitive world. Right from its inception in 2001, it has been tuning itself to meet this objective. A new civilization is emerging in our lives. This civilization brings with it a new way of working. Millions are already tuning their lives to the rhythms of tomorrow.

About the Mechanical Department

The Mechanical engineering is one of the core engineering departments, which has potential to accommodate all efficient engineers. The Mechanical engineers serve all other branches of engineering directly or indirectly. The Mechanical engineers can find their place in Automobile engineering sector, Steel Plants, Power plants, Software industries, Manufacturing industries, Design industries, Military, Naval and Air force, Defense research organizations, Material research organizations etc.

About the Workshop

AutoCAD is globally used by surveyors, designers, engineers, drafters. Globally, AutoCAD has proven as an efficient and user-friendly Program. Commercial drafting and computer-aided design(CAD) software applications are AutoCAD. AutoCAD software is recognized internationally for its remarkable editing capabilities, which make it likely to digitally draw building plans or recreate 3D images. AutoCAD is compatible with other applications like 3D Max. The designers can even import or export DWG & DXG Files to the application. Also, these files can even be exported from AutoCAD to other applications for creating more improved projects & presentations.

Organising committee

CHIEF PATRON

Sri.S.Sudershan Reddy

Chairman

Sri. S. Surendar Reddy

Secretary

Sri S. Dhanunjay Reddy

Joint Secretary

DIRECTOR

Dr. H. S. N. Murthy

PATRON

Dr.K.S.S.S.Reddy, Principal

CONVENER

Dr.S.Murali,

Professor,Dept. Of Mechanical

PROGRAM COORDINATORS

Mr.S.Sudhakara

K.Devi Singh

Conducted On

2/5/2017- 12/5/2017



MAHAVEER

INSTITUTE OF SCIENCE & TECHNOLOGY

Approved by AICTE, Affiliated to JNTU, Hyderabad.

Vvasapur, Bandlaguda, Post: Keethavari, Hyderabad-500005.



**Two week
Certification Course
on**

Auto CAD

Organized by

*Department of Mechanical
Engineering*

Vysapuri, Bandlaguda Post, Keshavnagar,
Hyderabad-500 005, Telangana INDIA
Tel: 040-64556979, 20020773, Fax: 040-24455003
E-mail: principal.mahaveer@gmail.com,
Website: www.mist.ac.in,

MAHAVEER



Approved by AICTE, Affiliated to JNTUHyd

Date: 29-04-2017

To
The Principal
MIST,
Hyderabad.

Sub: Proposal for Add-on Course-Reg.

Respected sir,

We are going to conduct 10 days Technical Training for II B. Tech students on "Introduction to Auto CAD". We require your approval to go head for proceeding and hope to get an opportunity to serve you the best.

With thanks and regards

Dr.S.Murali

HOD

Department of Mechanical Engineering



Date: 01.05.2017

CIRCULAR

Technical Training for II B. Tech students are starting from 2nd MAY, 2017 onwards. All HODs and Placements coordinators have to manage the trainings and ensure 95% attendance all through the sessions.

All Mentors need to send the compiled feedback report to Dr.S.Murali, HOD at e3hod.mech@gmail.com daily.

Agenda: 1. Introduction to AUTOCAD.

Design and Development of curriculum for Add on course:

Name of the Faculty : S.SUDHAKARA

Dr.S.Murali

HOD

Department of Mechanical Engineering

Keshavgi
PRINCIPAL
MAHAVEER
INSTITUTE OF SCIENCE & TECHNOLOGY
Bandlaguda, Hyd-500 005.



Auto CAD SYLLABUS

1: Getting Started with AutoCAD

- Opening and Creating Drawings
- Exploring the AutoCAD interface
- Zooming and Panning

2: Basic Drawing & Editing Commands

- Using the Mouse, Keyboard, and Enter Key to work quickly and efficiently in AutoCAD
- Lines
- Circles
- Rectangles

3: Projects - Creating a Simple Drawing

- Creating Simple Drawings
- Using Object Snap Tracking to extrapolate a projected top view
- Using Modify tools to arrange an office layout

4: Drawing Precision in AutoCAD

- Polar and Ortho Tracking
- Entering Coordinates and Angles
- Object Snaps and Tracking

5: Making Changes in Your Drawing

- Move
- Copy
- Rotate
- Mirror
- Scale
- Using the reference option with the Scale Tool

7: Organizing Your Drawing with Layers

- Layer States
- Properties by Layer
- Layer Tools

8: Advanced Object Types

- Polylines

Kshiraj
Principal
Mahaveer Institute of Technology
Vysapuri, Bandlaguda Post, Keshavnagar,
Hyderabad-500 005, Telangana INDIA
Tel: 040-64596979, 20020773, Fax: 040-24455003
E-mail: principalmahaveer@gmail.com,
Website: www.mst.ac.in



- Arcs
- Polygons
- Ellipses

9: Advanced Editing Commands

- Trim and Extend
- Fillet and Chamfer
- Polyline Edit and Spline
- Offset and Explode
- Join

10: Inserting Blocks

- The Insert Block Command
- Inserting Blocks with Tool Palettes
- Dynamic Bloes
- Migrating Blocks and other Elements between Drawings with Design Center

11: Text

- The Multiline Text Tool
- The Single Line Text Tool
- Editing Text
- Text in Model Space vs. Paper Space
- The Multileader Tool

12: Hatching

- The Hatch Command
- The Hatch Editor Ribbon Tab
- Saving and Applying Hatches with Tool Palettes

13: Adding Dimensions

- Using Dimensioning Tools
- Dimensioning in a Layout Tab vs. the Model Tab
- Using Dimension Styles
- Editing Dimensions

14: Projects - Annotating Your Drawing

- Dimensioning a Mechanical Drawing

Keshav
Principal
Mahaveer Institute of Technology
Vysapur, Bandlaguda Post, Keshavnagar,
Hyderabad - 500 025, Telangana, India
Tel: 040-64556379, 20020773
Fax: 040-24455003
E-mail: principal.mahaveer@gmail.com
Website: www.mst.ac.in



Department of Mechanical Engineering Auto CAD Technical Training student attendance list 2017-18

S.NO.	ROLL NO.	NAME OF THE STUDENT	YEAR
1	16E31A0301	B PRAVEEN KUMAR	II
2	16E31A0305	G RAMAKRISHNA	II
3	16E31A0306	G VENU GOPAL	II
4	16E31A0307	GADDI SUDHAMSHU	II
5	16E31A0308	GAJELLI VAMSHI KRISHNA	II
6	16E31A0313	KOVA SAIKUMAR	II
7	16E31A0314	LUNAVATH GANESH	II
8	16E31A0318	MOHAMMED MUBEEN QURESHI	II
9	16E31A0319	MOHD ABDUL SAMEER	II
10	16E31A0320	MOHD ABDUL AHTESHAM UL HASNAIN	II
11	16E31A0323	N SRIKANTH REDDY	II
12	16E31A0324	NALLA TEJASWI	II
13	16E31A0325	PANUGANTI SAI KIRAN GOUD	II
14	16E31A0326	PATLOLLA PRASHANTH REDDY	II
15	16E31A0327	PONNURU UPENDRA	II
16	16E31A0328	PULJALA ANIL	II
17	16E31A0329	PUNEET RAJ CHAVAN	II
18	16E31A0330	PUTTAPAD YADAAIAH	II
19	16E31A0331	R VAYU PUTHRA	II
20	16E31A0332	RAMAKRISHNA LAKMALA	II
21	16E31A0333	RAVULA HEMANTH KUMAR	II
22	16E31A0334	SHAIK MUJAFER	II

K. Srinivas

PRINCIPAL
EER
16/05/2017

Vysapuri, Bandlapada Post, Keshavnipi,
Nijeraband 503 005, Telangana INDIA
Tel: 040-84596379, 20020773, Fax: 040-24455003
E-mail: principal.mahaveer@gmail.com
Website: www.mst.ac.in

MAHAVEER



Approved by AICTE Affiliated to JNTU(Hyd)

23	16E31A0336	SYED ZAINUDDIN ABED	II
24	16E31A0337	TEJAVATH SRIKANTH	II
25	16E31A0338	THONGAR NARAYANA	II
26	16E31A0339	THOTA PAVAN KUMAR	II
27	16E31A0340	YELTI SREYA	II
28	16E31A0342	ABU SUFYAN MALIK	II
29	16E31A0343	AKASH SABHANI	II
30	16E31A0344	AMERINANI ANIL KUMAR	II
31	16E31A0345	ARAKALA SHIVA	II
32	16E31A0346	BAGI VIJENDER REDDY	II
33	16E31A0350	DEVI SHRI PRASAD PATANGI	II
34	16E31A0351	EDAM SAIRAM	II
35	16E31A0352	ERLA MAHENDRA KUMAR	II
36	16E31A0353	ISHIRATH UNNISA BEGUM	II
37	16E31A0354	KATPALLY SRENU REDDY	II
38	16E31A0356	KOLLA RAJASHEKAR REDDY	II
39	16E31A0358	KOMMIDI SHRAVAN REDDY	II
40	16E31A0360	KOTHALAPURAM ANUSHA	II
41	16E31A0361	KUDUTHALA AKHIL	II
42	16E31A0362	MADHAGONE AKHIL TEJA	II
43	16E31A0364	MOHAMMED LUQMAN ZAKI	II
44	16E31A0365	MOHAMMED RIZWANUDDIN	II
45	16E31A0368	PATHAKOTI JAGADISH	II
46	16E31A0369	PULUGARI JAGADEESHWAR REDDY	II
47	16E31A0370	PYATA PRASHANTH KUMAR	II
48	16E31A0371	SHAIK SAMEER	II

K. K. K.
MAHAVEER
Principal, Vysapuri, Bandlapada Post, Keshavnipi,
Nijeraband 503 005, Telangana INDIA
Tel: 040-84596379, 20020773, Fax: 040-24455003
E-mail: principal.mahaveer@gmail.com
Website: www.mst.ac.in

Vysapuri, Bandlaguda Post, Keshavnagar,
Hyderabad-500 005, Telangana INDIA
Tel: 040-64596979, 20020773, Fax: 040-24455003
E-mail: principal.mahaveer@gmail.com,
Website: www.mist.ac.in

MAHAVEER



Approved by AICTE, Affiliated to JNTU, Hyd

49	16E31A0374	SYED OMAIR AHMED	II
50	16E31A0376	TUMMALA PALLY VINAY REDDY	II
51	16E31A0377	V SHIVA KUMAR REDDY	II
52	16E31A0378	VALGOTE NIKHIL KUMAR	II
53	16E31A0379	YATA VISHNUVARDHAN REDDY	II
54	15E31A0324	K SAI TEJA	II
55	15E31A0323	K RAJESH	II
56	15E31A0326	MD ABUBAKAR SIDDIQ	II
57	17E35A0301	ALAKANTI SWARAJYAM	II
58	17E35A0302	B MAHESH	II
59	17E35A0303	BHOOMENI VENKATA SAI	II
60	17E35A0304	BODIGAM SRINATH	II
61	17E35A0305	GOMASA HARSHAVARDHAN	II
62	17E35A0306	JAMPALA SAIKUMAR	II
63	17E35A0307	KAIRAMKONDA SURESH	II
64	17E35A0308	KARISHA SURESH	II
65	17E35A0309	KONKATA KARTHIK	II
66	17E35A0310	KUMMARA PAVANKUMAR	II
67	17E35A0311	MAHESH	II
68	17E35A0312	MD ASIF	II
69	17E35A0313	MOGUNURI NARENDRA	II
70	17E35A0314	MOHAMMED ABDUL RAQEEB	II
71	17E35A0316	PAISHETTY NAGA VAMSHI	II
72	17E35A0317	PANTHULU TARUN KUMAR	II
73	17E35A0318	PORISHETTI BHANUCHANDER	II
74	17E35A0319	SAMBARBANDA RAGHAVENDRA REDDY	II

PRINCIPAL
K. Mahaveer
MAHAVEER
INSTITUTE OF MANAGEMENT STUDIES AND TECHNOLOGY
Bandlaguda, Hyderabad-500 005

Vysapuri, Banthiguda Post, Keshavnagar,
Hyderabad-500 005, Telangana, INDIA
Tel: 040-84596979, 20029773, Fax: 040-24455003
E-mail: principal.mahaveer@gmail.com
Website: www.mst.ac.in

MAHAVEER



Approved by AICTE, Affiliated to JNTU, Hyderabad

75	17E35A0320	SHAIK MINHAIJ UDDIN	II
76	17E35A0321	SYED SOHAIL AHMED	II
77	17E35A0322	VADLA SRIKANTH	II
78	15E31A0335	MOHD ABDUL HASEEB	II
69	17E35A0313	MOGUNURI NARENDRA	II
70	17E35A0314	MOHAMMED ABDUL RAQEEB	II
71	17E35A0316	PAISHETTY NAGA VAMSHI	II
72	17E35A0317	PANTHULU TARUN KUMAR	II
73	17E35A0318	PORISHETTI BHANUCHANDER	II
74	17E35A0319	SAMSARBANDA RAGHAVENDRA REDDY	II
75	17E35A0320	SHAIK MINHAIJ UDDIN	II
76	17E35A0321	SYED SOHAIL AHMED	II
77	17E35A0322	VADLA SRIKANTH	II
78	15E31A0335	MOHD ABDUL HASEEB	II

Mahaveer
MAHAVEER
INSTITUTE OF SCIENCE & TECHNOLOGY
Banthiguda, Hyderabad-500005



Technical Training Exam on Auto CAD Software (A.Y-2017-18)

2x10=20 Marks

Answer All the Questions

1. Draw the given 2D model into 3D model by using AutoCad

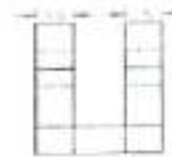
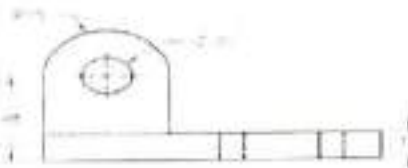
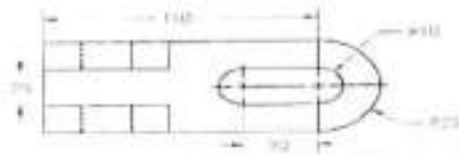

2. Draw the given 2D model into 3D model by using Auto CAD.

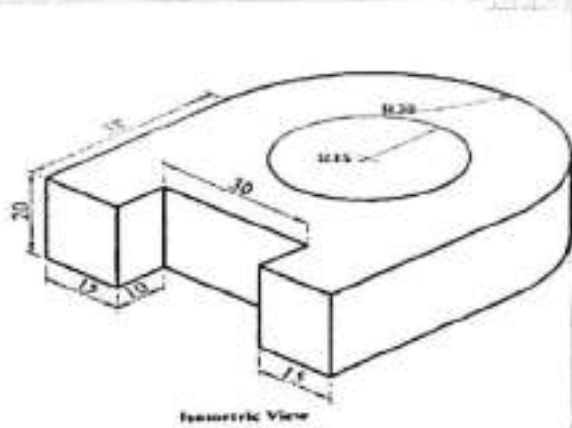
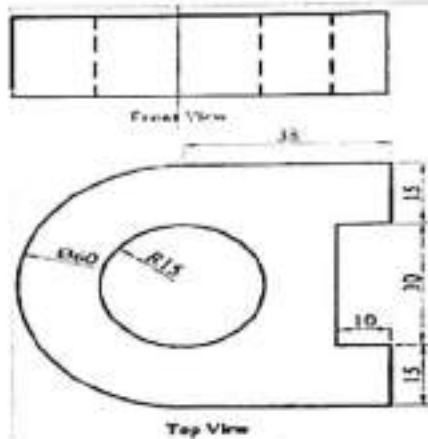

Kalyan
MAHAVEER
INSTITUTE OF TECHNOLOGY & ENGINEERING
Bandlaguda, Hyd-500 005



Department of Mechanical Engineering
Auto CAD Technical Training student Marks list 2017-18

S.NO	Roll No	Name of the student	YEAR	MARKS	PASS/FAIL
1	16E31A0301	B PRAVEEN KUMAR	II	15	PASS
2	16E31A0305	G RAMAKRISHNA	II	15	PASS
3	16E31A0306	G VENU GOPAL	II	16	PASS
4	16E31A0307	GADDI SUDHAMSHU	II	15	PASS
5	16E31A0308	GAJELLI VAMSHI KRISHNA	II	15	PASS
6	16E31A0313	KOVA SAIKUMAR	II	15	PASS
7	16E31A0314	LUNAVATH GANESH	II	15	PASS
8	16E31A0318	MOHAMMED MUBEEN QURESHI	II	16	PASS
9	16E31A0319	MOHD ABDUL SAMEER	II	15	PASS
10	16E31A0320	MOHD ABDUL AHTESHAM UL HASNAIN	II	14	PASS
11	16E31A0323	N SRIKANTH REDDY	II	18	PASS
12	16E31A0324	NALLA TEJASWI	II	15	PASS
13	16E31A0325	PANUGANTI SAI KIRAN GOUD	II	16	PASS
14	16E31A0326	PATLOLLA PRASHANTH REDDY	II	16	PASS
15	16E31A0327	PONNURU UPENDRA	II	15	PASS
16	16E31A0328	PULJALA ANIL	II	16	PASS
17	16E31A0329	PUNEET RAJ CHAVAN	II	16	PASS
18	16E31A0330	PUTTAPAD YADIAH	II	16	PASS
19	16E31A0331	R VAYU PUTHRA	II	16	PASS
20	16E31A0332	RAMAKRISHNA LAKMALA	II	16	PASS
21	16E31A0333	RAVULA HEMANTH KUMAR	II	16	PASS
22	16E31A0334	SHAIK MUJAFER	II	15	PASS
23	16E31A0336	SYED ZAINUDDIN ABED	II	15	PASS

Principal
 Mahaveer Institute of Technology
 Vysampati, Bandlaguda Post, Keeravani,
 Hyderabad 500 025, Telangana INDIA

Vysreppati Bandragunta Post, Krishna
Hyderabad 515 001, Telangana INDIA
Tel: 040-84599379, 20020773 Fax: 040-24455093
E-mail: principal.mahaveer@gmail.com
Website: www.mahaveer.ac.in

MAHAVEER



A, approved by AICTE, Affiliated to JNTU, Hyd

24	16E31A0337	TEJAVATH SRIKANTH	II	15	PASS
25	16E31A0338	THONGAR NARAYANA	II	15	PASS
26	16E31A0339	THOTA PAVAN KUMAR	II	15	PASS
27	16E31A0340	VELTI SREYA	II	15	PASS
28	16E31A0342	ABU SUFYAN MALIK	II	15	PASS
29	16E31A0343	AKASH SABBINANI	II	16	PASS
30	16E31A0344	AMERINANI ANIL KUMAR	II	15	PASS
31	16E31A0345	ARAKALA SHIVA	II	14	PASS
32	16E31A0346	BAGI VIJENDER REDDY	II	18	PASS
33	16E31A0350	DEVI SHRI PRASAD PATANGI	II	15	PASS
34	16E31A0351	EDAM SAIRAM	II	16	PASS
35	16E31A0352	ERLA MAHENDRA KUMAR	II	16	PASS
36	16E31A0353	ISHRATH UNNISA BEGUM	II	15	PASS
37	16E31A0354	KATPALLY SRENU REDDY	II	16	PASS
38	16E31A0356	KOLLA RAJASHEKAR REDDY	II	15	PASS
39	16E31A0358	KOMMIDI SHRAVAN REDDY	II	14	PASS
40	16E31A0360	KOTHALAPURAM ANUSHA	II	18	PASS
41	16E31A0361	KUDUTHALA AKHIL	II	15	PASS
42	16E31A0362	MADHAGONE AKHIL TEJA	II	16	PASS
43	16E31A0364	MOHAMMED LUQMAN ZAKI	II	16	PASS
44	16E31A0365	MOHAMMED RIZWANUDDIN	II	15	PASS
45	16E31A0368	PATHAKOTI JAGADISH	II	16	PASS
46	16E31A0369	PULUGARI JAGADEESHWAR REDDY	II	14	PASS
47	16E31A0370	PYATA PRASHANTH KUMAR	II	18	PASS
48	16E31A0371	SHAIK SAMEER	II	15	PASS
49	16E31A0374	SYED OMAIR AHMED	II	16	PASS

K. Srinivas
Principal
MAHAVEER
EDUCATION TRUST
Vysreppati Bandragunta
Post, Krishna District
Hyderabad - 515 001

Vysapur, Bandlaguda Post Keshavn,
Hyderabad 508 025, Telangana INDIA
Tel: 040-8459379, 20020773, Fax: 040-24455003
E-mail: principal.mahaveer@gmail.com
Website: www.mst.ac.in

MAHAVEER



Approved by AICTE, Affiliated to JNTUH Hyd

50	16E31A0376	TUMMALA PALLY VINAY REDDY	II	15	PASS
51	16E31A0377	V SHIVA KUMAR REDDY	II	16	PASS
52	16E31A0378	VALGOTE NIKHIL KUMAR	II	15	PASS
53	16E31A0379	YATA VISHNUVARDHAN REDDY	II	16	PASS
54	15E31A0324	K SAI TEJA	II	15	PASS
55	15E31A0323	K RAJESH	II	14	PASS
56	15E31A0326	MD ABUBAKAR SIDDIQ	II	18	PASS
57	17E35A0301	ALAKANTI SWARAJYAM	II	15	PASS
58	17E35A0302	B MAHESH	II	16	PASS
59	17E35A0303	BHOOMENI VENKATA SAI	II	15	PASS
60	17E35A0304	BODIGAM SRINATH	II	16	PASS
61	17E35A0305	GOMASA HARSHAVARDHAN	II	15	PASS
62	17E35A0306	JAMPALA SAIKUMAR	II	16	PASS
63	17E35A0307	KAIRAMKONDA SURESH	II	15	PASS
64	17E35A0308	KARISHA SURESH	II	14	PASS
65	17E35A0309	KONKATA KARTHIK	II	18	PASS
66	17E35A0310	KUMMARA PAVANKUMAR	II	15	PASS
67	17E35A0311	MAHESH	II	16	PASS
68	17E35A0312	MD ASH	II	16	PASS
69	17E35A0313	MOGUNURI NARENDRA	II	15	PASS
70	17E35A0314	MOHAMMED ABDUL RAQEEB	II	16	PASS
71	17E35A0316	PAISHETTY NAGA VAMSHI	II	15	PASS
72	17E35A0317	PANTHULU TARUN KUMAR	II	14	PASS
73	17E35A0318	PORISHETTI BHANUCHANDER	II	18	PASS
74	17E35A0319	SAMSARBANDA RAGHAVENDRA REDDY	II	15	PASS
75	17E35A0320	SHAIK MINHAIJ UDDIN	II	16	PASS

Kishor
MAHAVEER
MSTP
Bandlaguda, Hyderabad-508 025

Vysapur, Bandlaguda Post, Keshavnagar,
Hyderabad-500 005, Telangana INDIA.
Tel: 040-64596979,20020773, Fax: 040-24455603
E-mail: principal.mahaveer@gmail.com
Website: www.mist.ac.in

MAHAVEER



Approved by AICTE, Affiliated to JNTUH, Hyd.

76	17E35A0321	SYED SOHAIL AHMED	II	16	PASS
77	17E35A0322	VADLA SRIKANTH	II	15	PASS
78	15E31A0335	MOHD ABDUL HASEEB	II	16	PASS

Kishor
PRINCIPAL
MAHAVEER
INSTITUTE OF TECHNOLOGY AND ENGINEERING
Bandlaguda, Hyd-500 005.

Vysapuri, Bandlaguda Post, Keshavnagar,
Hyderabad-500 005, Telangana INDIA
Tel: 040-64556379, 20020773, Fax: 040-24415003
E-mail: principal.mahaveer@gmail.com,
Website: www.mahaveer.ac.in

MAHAVEER



Approved by AICTE, Affiliated to JNTUH Hyd

Auto CAD COURSE Summary

Department of Mechanical Engineering

- Use AutoCAD for daily working process.
- Navigate throughout AutoCAD using major navigating tools.
- Understand the concept and techniques to draw.
- Create multiple designs using several of tools.
- Create layers to control the objects' visibility.
- Explain drawing using annotations.
- Plot or print the drawing by scale.
- To use constraint for certain design.

Copy to :

1. Department of Notice Board
2. Principal for Information
3. Committee Members (Academic)

K. Srinivas
Principal
MAHAVEER INSTITUTE OF TECHNOLOGY
Bandlaguda, Hyderabad-500 005.

Vysapur, Bandlaguda Post Keshavnagar,
Hyderabad 500 005, Telangana INDIA
Tel: 040-64596979, 20029773, Fax: 040-24455003
E-mail: principal.mahaveer@gmail.com,
Website: www.mst.ac.in

MAHAVEER



Approved by AICTE. Affiliated to JNTUHHyd

CERTIFICATE OF COURSE COMPLETION

This certificate is presented to Yelji Sreya of
MIST, who has successfully completed technical training course on
"Auto CAD" held from 02-05-2017 to 12-05-2017 and found the
student performance to be excellent.

Kishor

PRINCIPAL
MAHAVEER
INSTITUTE OF SCIENCE & TECHNOLOGY
BANDLAGUDA, HYD-500 005.



ESTD : 2001

Dr. S. Suresh

Dr. S. Suresh

HOD

Department of Mechanical Engineering



DEPARTMENT OF MECHANICAL ENGINEERING

List of students enrolled in Auto CAD (2017-2018)

S.No	Roll No	Name of the student	Date											
			2/5/17	3/5/17	4/5/17	5/5/17	6/5/17	7/5/17	8/5/17	9/5/17	10/5/17	11/5/17	12/5/17	
1	16E31A0301	B PRAVEEN KUMAR	P	P	P	P	P	P	P	P	P	P	P	
2	16E31A0305	G RAMAKRISHNA	P	P	P	P	P	P	P	P	P	P	P	
3	16E31A0306	G VENU GOPAL	P	P	P	P	P	P	P	P	P	P	P	
4	16E31A0307	GADDI SUDHAMSHU	P	P	P	P	P	P	P	P	P	P	P	
5	16E31A0308	GAJELLI VAMSHI KRISHNA	P	P	P	P	P	P	P	P	P	P	P	
6	16E31A0313	KOVA SAIKUMAR	P	P	P	P	P	P	P	P	P	P	P	
7	16E31A0314	LUNAVATH GANESH	P	P	P	P	P	P	P	P	P	P	P	
8	16E31A0318	MOHAMMED MUBEEN QURESHI	P	P	P	P	P	P	P	P	P	P	P	
9	16E31A0319	MOHD ABDUL SAMEER	P	P	P	P	P	P	P	P	P	P	P	

Kishu

27/05/17



DEPARTMENT OF MECHANICAL ENGINEERING

List of students enrolled in Auto CAD (2017-2018)

10	16E31A0320	MOHD ABDUL AHTESHAM UL HASNAIN	P	P	P	P	P	P	P	P	P	P
11	16E31A0323	N SRIKANTH REDDY	P	P	P	P	P	P	P	P	P	P
12	16E31A0324	NALLA TEJASWI	P	P	P	P	P	P	P	P	P	P
13	16E31A0325	PANUGANTI SAI KIRAN GOUD	P	P	P	P	P	P	P	P	P	P
14	16E31A0326	PATLOLLA PRASHANTH REDDY	P	P	P	P	P	P	P	P	P	P
15	16E31A0327	PONNURU UPENDRA	P	P	P	P	P	P	P	P	P	P
16	16E31A0328	PULJALA ANIL	P	P	P	P	P	P	P	P	P	P
17	16E31A0329	PUNEET RAJ CHAVAN	P	P	P	P	P	P	P	P	P	P
18	16E31A0330	PUTTAPAD YADAIANI	P	P	P	P	P	P	P	P	P	P
19	16E31A0331	R VAYU PUTHRA	P	P	P	P	P	P	P	P	P	P

Kalyan



DEPARTMENT OF MECHANICAL ENGINEERING

List of students enrolled in Auto CAD (2017-2018)

20	16E31A0332	RAMAKRISHNA LAKMALA	P	P	P	P	P	P	P	P	P	P
21	16E31A0333	RAVULA HEMANTH KUMAR	P	P	P	P	P	P	P	P	P	P
22	16E31A0334	SHAIK MUJAFFER	P	P	P	P	P	P	P	P	P	P
23	16E31A0336	SYED ZAINUDDIN ABED	P	P	P	P	P	P	P	P	P	P
24	16E31A0337	TEJAVATH SRIKANTH	P	P	P	P	P	P	P	P	P	P
25	16E31A0338	THONGAR NARAYANA	P	P	P	P	P	P	P	P	P	P
26	16E31A0339	THOTA PAVAN KUMAR	P	P	P	P	P	P	P	P	P	P
27	16E31A0340	YELTI SREYA	P	P	P	P	P	P	P	P	P	P
28	16E31A0342	ABU SUFYAN MALIK	P	P	P	P	P	P	P	P	P	P
29	16E31A0343	AKASH SABHANI	P	P	P	P	P	P	P	P	P	P
30	16E31A0344	AMERINANI ANIL KUMAR	P	P	P	P	P	P	P	P	P	P



DEPARTMENT OF MECHANICAL ENGINEERING

List of students enrolled in Auto CAD (2017-2018)

31	16E31A0345	ARAKALA SHIVA	P	P	P	P	P	P	P	P	P	P
32	16E31A0346	BAGI VIJENDER REDDY	P	P	P	P	P	P	P	P	P	P
33	16E31A0350	DEVI SHRI PRASAD PATANGI	P	P	P	P	P	P	P	P	P	P
34	16E31A0351	EDAM SAIRAM	P	P	P	P	P	P	P	P	P	P
35	16E31A0352	ERLA MAHENDRA KUMAR	P	P	P	P	P	P	P	P	P	P
36	16E31A0353	ISHRATH UNNISA BEGUM	P	P	P	P	P	P	P	P	P	P
37	16E31A0354	KATPALLY SRENI REDDY	P	P	P	P	P	P	P	P	P	P
38	16E31A0356	KOLLA RAJASHEKAR REDDY	P	P	P	P	P	P	P	P	P	P
39	16E31A0358	KOMMIDI SHRAVAN REDDY	P	P	P	P	P	P	P	P	P	P



DEPARTMENT OF MECHANICAL ENGINEERING

List of students enrolled in Auto CAD (2017-2018)

40	16E31A0360	KOTHALAPURAM ANUSHA	P	P	P	P	P	P	P	P	P	P
41	16E31A0361	KUDUTHALA AKHIL	P	P	P	P	P	P	P	P	P	P
42	16E31A0362	MADHAGONE AKHIL TEJA	P	P	P	P	P	P	P	P	P	P
43	16E31A0364	MOHAMMED LUQMAN ZAKI	P	P	P	P	P	P	P	P	P	P
44	16E31A0365	MOHAMMED RIZWANUDDIN	P	P	P	P	P	P	P	P	P	P
45	16E31A0368	PATHAKOTI JAGADISH	P	P	P	P	P	P	P	P	P	P
46	16E31A0369	PULUGARI JAGADEESHWAR REDDY	P	P	P	P	P	P	P	P	P	P
47	16E31A0370	PYATA PRASHANTH KUMAR	P	P	P	P	P	P	P	P	P	P
48	16E31A0371	SHAIK SAMEER	P	P	P	P	P	P	P	P	P	P
49	16E31A0374	SYED OMAIR AHMED	P	P	P	P	P	P	P	P	P	P

Handwritten signature
M. SURESH
Principal
Date: _____



DEPARTMENT OF MECHANICAL ENGINEERING

List of students enrolled in Auto CAD (2017-2018)

50	16E31A0376	TUMMALA PALLY VINAY REDDY	P	P	P	P	P	P	P	P	P	P
51	16E31A0377	V SHIVA KUMAR REDDY	P	P	P	P	P	P	P	P	P	P
52	16E31A0378	VALGOTE NIKHIL KUMAR	P	P	P	P	P	P	P	P	P	P
53	16E31A0379	YATA VISHNUVARDHAN REDDY	P	P	P	P	P	P	P	P	P	P
54	15E31A0324	K SAI TEJA	P	P	P	P	P	P	P	P	P	P
55	15E31A0323	K RAJESH	P	P	P	P	P	P	P	P	P	P
56	15E31A0326	MD ABUBAKAR SIDDIQ	P	P	P	P	P	P	P	P	P	P
57	17E35A0301	ALAKANTI SWARAJYAM	P	P	P	P	P	P	P	P	P	P
58	17E35A0302	B MAHESH	P	P	P	P	P	P	P	P	P	P
59	17E35A0303	BHOOMENI VENKATA SAI	P	P	P	P	P	P	P	P	P	P
60	17E35A0304	BODIGAM SRINATHI	P	P	P	P	P	P	P	P	P	P

Principal
PRINCIPAL
MAHAVEER
INSTITUTE OF SCIENCE & TECHNOLOGY
BANDLAGUDA, HYD-500 005.



DEPARTMENT OF MECHANICAL ENGINEERING

List of students enrolled in Auto CAD (2017-2018)

61	17E35A0305	GOMASA HARSHAVARDHAN	P	P	P	P	P	P	P	P	P	P
62	17E35A0306	JAMPALA SAIKUMAR	P	P	P	P	P	P	P	P	P	P
63	17E35A0307	KAIRAMKONDA SURESH	P	P	P	P	P	P	P	P	P	P
64	17E35A0308	KARISHA SURESH	P	P	P	P	P	P	P	P	P	P
65	17E35A0309	KONKATA KARTHIK	P	P	P	P	P	P	P	P	P	P
66	17E35A0310	KUMMARA PAVANKUMAR	P	P	P	P	P	P	P	P	P	P
67	17E35A0311	MAHESH	P	P	P	P	P	P	P	P	P	P
68	17E35A0312	MD ASIF	P	P	P	P	P	P	P	P	P	P
69	17E35A0313	MOGUNURI NARENDRA	P	P	P	P	P	P	P	P	P	P
70	17E35A0314	MOHAMMED ABDUL RAQEEB	P	P	P	P	P	P	P	P	P	P
71	17E35A0316	PAISHETTY NAGA VAMSHI	P	P	P	P	P	P	P	P	P	P
72	17E35A0317	PANTHULU TARUN KUMAR	P	P	P	P	P	P	P	P	P	P

PRINCIPAL
Whitney
MAHAVEER
INSTITUTE OF SCIENCE AND TECHNOLOGY
Bandlaguda, Hyderabad-500 005.



DEPARTMENT OF MECHANICAL ENGINEERING

List of students enrolled in Auto CAD (2017-2018)

73	17E35A0318	PORISHETTI BHANUCHANDER	P	P	P	P	P	P	P	P	P	P
74	17E35A0319	SAMSARBANDA RAGHAVENDRA REDDY	P	P	P	P	P	P	P	P	P	P
75	17E35A0320	SHAIK MINHAJ UDDIN	P	P	P	P	P	P	P	P	P	P
76	17E35A0321	SYED SOHAIL AHMED	P	P	P	P	P	P	P	P	P	P
77	17E35A0322	VADLA SRIKANTHI	P	P	P	P	P	P	P	P	P	P
78	15E31A0335	MOHD ABDUL HASEEB	P	P	P	P	P	P	P	P	P	P

Kshiti
Principal
17E35A0318
17E35A0319
17E35A0320
17E35A0321
17E35A0322
15E31A0335

About the College

As an Institute committed in quality education, MIST aims at providing learning with a Technology-edge. It endeavors to provide consistent training to its students to help them evolve as competent professionals in the highly competitive world. Right from its inception in 2001, it has been tuning itself to meet this objective. A new civilization is emerging in our lives. This civilization brings with it a new way of working. Millions are already tuning their lives to the rhythms of tomorrow.

About the Mechanical Dept.

The Mechanical engineering is one of the core engineering departments, which has potential to accommodate all efficient engineers. The Mechanical engineers serve all other branches of engineering directly or indirectly. The Mechanical engineers can find their place in Automobile engineering sector, Steel Plants, Power plants, Software industries, Manufacturing industries, Design industries, Military, Naval and Air force, Defense research organizations, Material research organizations etc.

About the Workshop

CATIA delivers the unique ability not only to model any product, but to do so in the context of its real-life behavior: design in the age of experience. CATIA (Computer-Aided Three dimensional Interactive Application) software is a complete multi-platform solution for computer-aided design, manufacturing, engineering, 3D and PLM. Marketed by manufacturer Dassault Systèmes, the software is ideal for creating solids, surfaces, assemblies, drawings, fabrication and analysis. However, CATIA offers more advanced functionality for surfaces and modules for different industries.

Organizing committee

CHIEF PATRON

Sri.S.Sudershan Reddy

Chairman

Sri. S. Surendar Reddy

Secretary

Sri S. Dhanunjay Reddy

Joint Secretary

DIRECTOR

Dr. H. S. N. Murthy

PATRON

Dr K.S.S.S.N Reddy. Principal

CONVENER

Dr.S.Murali

Professor, Dept. Of Mechanical

PROGRAM COORDINATORS

N.Sathish Kumar

Duration

02/05/2017-12/5/2017



ESTD: 2001

MAHAVEER

INSTITUTE OF SCIENCE & TECHNOLOGY

Approved by AICTE, Affiliated to JNTU, Hyderabad.

Vyasapuri, Bandlaguda, Post: Keshavnipi, Hyderabad-500005.



**Two week
Certification Course
on**

Introduction to CATIA

Organized by

*Department of Mechanical
Engineering*

Vysapuri, Bandlaguda Post, Keshavnagar,
Hyderabad-500 005, Telangana (INDIA)
Tel: 040-64506979, 20020773, Fax: 040-24455091
E-mail: principal.mahaveer@gmail.com,
Website: www.mist.ac.in,

MAHAVEER



Approved by AICTE - Attached No. JN110777/1

Date: 29-04-2017

To
The Principal
MIST,
Hyderabad.

Sub: Proposal for Add-on Course-Reg.

Respected sir,

We are going to conduct 10 days Technical Training for III B. Tech students on "Introduction to CATIA". We require your approval to go head for proceeding and hope to get on opportunity to serve you the best.

With thanks and regards

Dr.S.Murali

HOD

Department of Mechanical Engineering

Murali
MAHAVEER
INSTITUTE OF TECHNOLOGY AND ENGINEERING
VYSAPURI, BANDLAGUDA POST, KESHAVNAGAR,
HYDERABAD-500005, TELANGANA (INDIA)



Date: 01.05.2017

CIRCULAR

Technical Training for III B. Tech students are starting from 2nd MAY, 2017 onwards. All HODs and Placements coordinators have to manage the trainings and ensure 95% attendance all through the sessions.

All Mentors need to send the compiled feedback report to Dr.S.Murali, HOD .

Agenda:

1. Introduction to CATIA.

Design and Development of curriculum for Add on course:

Name of the Faculty : N.Satish Kumar

PRINCIPAL
MAHAVEER
INSTITUTE OF SCIENCE & TECHNOLOGY
Bandlaguda, Hyd-500 005.

HOD

Department of Mechanical Engineering



CATIA SYLLABUS

Total Hours: 48

I. Introduction:

- Modulus
- Features (powerful Tools
- Parametric modeling
- Feature based approach
- Parent – child Relationship)
- Associative and Model Centric
- b) Information about Interface
- Tools, Menu, etc.

II. Sketcher:

- Getting Started
- Interface
- Sketch tools
- Profiles
- Operations
- Constraints
- Sketcher preferences
- References

III. Part Features:

- Sketch Based Features
- Pad
- Pocket
- Thin
- Shaft
- Groove

K. V. V.
PRINCIPAL
MAHAVEER
INSTITUTE OF TECHNOLOGY AND EDUCATION
VYSAPURI, BANDLAGUDA POST, KESHAVGIRI,
HYDERABAD-500 005, TELANGANA INDIA

- Hole
- Threaded Hole
- Rib
- Slot & Stiffener
- Multi section solid

IV. Dress-up Features

- Fillet
- Chamfer
- Draft
- Shell
- Thickness
- Thread/Tap

V. Reference Element

- Point
- Line
- Plane

VI. Assembly Modeling:

- Assembly Constraints
- Manipulation
- Defining a multi & fast multi-instantiation
- Analyzing an assembly

VII. Drafting:

- Sheets & Views
- View modification
- Generating dimensions
- Bill of material
- Dimensions
- Annotations
- Dress up Elements
- Properties
- Exporting and Importing files

Handwritten signature

Handwritten text

Handwritten text

Handwritten text

Handwritten text



Department of Mechanical Engineering
CATIA Technical Training student attendance list 2017-18

S.NO.	ROLL NO.	NAME OF THE STUDENT	YEAR
1	15E31A0301	ABDUL ABRAR	III
2	15E31A0302	ABDUL RAHMAN	III
3	15E31A0303	ANAND KUMAR	III
4	15E31A0304	AQUEEB UDDIN FIRDUSHI	III
5	15E31A0305	ATTLURI SURESH REDDY	III
6	15E31A0306	BANDA SATYA SHIVA REDDY	III
7	15E31A0310	BIJOMENI NARENDHAR	III
8	15E31A0311	BICHIKUNDA SUNIL KUMAR	III
9	15E31A0313	CHIDIRALA RAJKUMAR	III
10	15E31A0315	DESHAGOUNI MOHAN SAI	III
11	15E31A0317	GURRALA VENKATA NARSI REDDY	III
12	15E31A0318	HUSSAIN FAIZ ULLAH	III
13	15E31A0319	K SAMPATH	III
14	15E31A0320	KASIREDDY SAIMANOJ REDDY	III
15	15E31A0321	KATTA SRIKANTH REDDY	III
16	15E31A0322	KESHETTI NIKHIL	III
17	15E31A0325	M A LATEEF	III
18	15E31A0327	MANCHIKANTI ARAVIND REDDY	III
19	15E31A0329	MD UBED UL RAHMAN	III
20	15E31A0331	MOHAMMED ABDULLAH ZUBAIR	III
21	15E31A0332	MOHAMMED AJAZ	III
22	15E31A0333	MOHAMMED ISMAIL FURQAN	III
23	15E31A0334	MOHD ABDUL ATIF	III

K. S. V.
PRINCIPAL
MAHAVEER
INSTITUTE OF ENGINEERING & TECHNOLOGY
Bandlaguda, Hyderabad-500 005.

Vysapuri, Bandlaguda Post, Keshavnagar,
Hyderabad-500 005, Telangana INDIA
Tel: 040-64596979, 20020773, Fax: 040-24455003
E-mail: principal.mahaveer@gmail.com,
Website: www.mahaveer.ac.in

MAHAVEER



Approved by AICTE. Affiliated to JNTU, Hydr

24	15E31A0336	MOHD ASIM KHAN	III
25	15E31A0337	MOHD FARHAN AHMED SHAREEF	III
26	15E31A0338	MOHD SALA UDDIN	III
27	15E31A0340	MOHD TALHA	III
28	15E31A0341	MUDAVATH SRINIVAS	III
29	15E31A0342	NELLURI AJAY KUMAR	III
30	15E31A0343	PADAMATINTI AVINASHI	III
31	15E31A0344	PALNATI SRIKANTH REDDY	III
32	15E31A0346	POLAKA PARDHA SARADHI REDDY	III
33	15E31A0349	SABHAVATH SEVYA	III
34	15E31A0350	SHADMAN ASHIRAF	III
35	15E31A0351	SHAIK ABDUL SAIF	III
36	15E31A0352	SHAIK ARIF HUSSAIN	III
37	15E31A0354	SOHAIL MOHAMMED MASOOD AHMED KHAN	III
38	15E31A0356	SYED BAHAUDDIN	III
39	15E31A0360	SYED QAMAR UDDIN RAZA SHAH QUADRI	III
40	15E31A0361	SYED SHAHED AHMED	III
41	15E31A0362	T KULDEEP SINGH	III
42	15E31A0363	TANNEERU RAJA	III
43	15E31A0365	VANGAPALLY SRINIVAS	III
44	16E35A0301	AMAR BIRADAR	III
45	16E35A0302	BHUKYA RAMA	III
46	16E35A0303	DHARAVATH RAVINDER NAYAK	III
47	16E35A0304	EROJI SURESH	III
48	16E35A0305	GOURAV KUMAR JHA	III
49	16E35A0306	KALIKOTA SAI CHARAN	III

Khan
PRINCIPAL
MAHAVEER
INSTITUTE OF TECHNOLOGY
Bandlaguda, Hyderabad

Vysapuri, Bandlaguda Post Keshavnagar,
Hydrabad-500 005, Telangana INDIA
Tel: 040-64596379,20020773, Fax: 040-24455003
E-mail: principal.mahaveer@gmail.com
Website: www.mist.ac.in

MAHAVEER



Approved by AICTE, Affiliated to JNTU(Hyd)

50	16E35A0307	MANYALA SAITEJA	III
51	16E35A0308	TADEM BHARATH KUMAR	III
52	16E35A0310	TANGELLA ASHOKA VARDHAN RAJU	III
53	14E31A0303	ANSAR AHMED KHAN	III
54	14E31A0334	MOHAMMED ABRAR AHMED	III
55	14E31A0335	MOHAMMED AKIF AHMED	III
56	14E31A0373	G KARTHIK RAJ	III
57	14E31A0374	A KAUSHIK VILAS	III
58	14E31A0386	MOHAMMED SOHAIB	III
59	14E31A0397	SYED SIKANDER ALI	III
60	14E31A0398	SYED VIKAYAT ULLAH	III
61	15E35A0301	E MADHUKAR	III
62	13E31A0304	AKASH HANVETHI	III
63	14E31A0390	RAHUL SINGH	III
64	14E31A0376	IMAMD HASAN KHAN	III
65	14E31A0359	TAMMARASHI AJAY KUMAR	III
66	13E31A0350	S KUNAL	III
67	14E31A0341	MOHD KHAHA MOHIUDDIN	III
68	14E31A0352	SAIFULLAH EKARAN JALKOTE	III
69	14E31A0337	MOHD ADNAN AZHAR	III
70	14E31A0339	MOHD ABDUL HAMEED GOURI	III

K. S. S.
PRINCIPAL
MAHAVEER
INSTITUTE OF SCIENCE & TECHNOLOGY
Bandlaguda, Hyd-500 005.



Technical Training Exam on Catia Software (A.Y-2017-18)

2x10=20 Marks

Answer All the Questions

1. Draw the given figure by using Catia software.

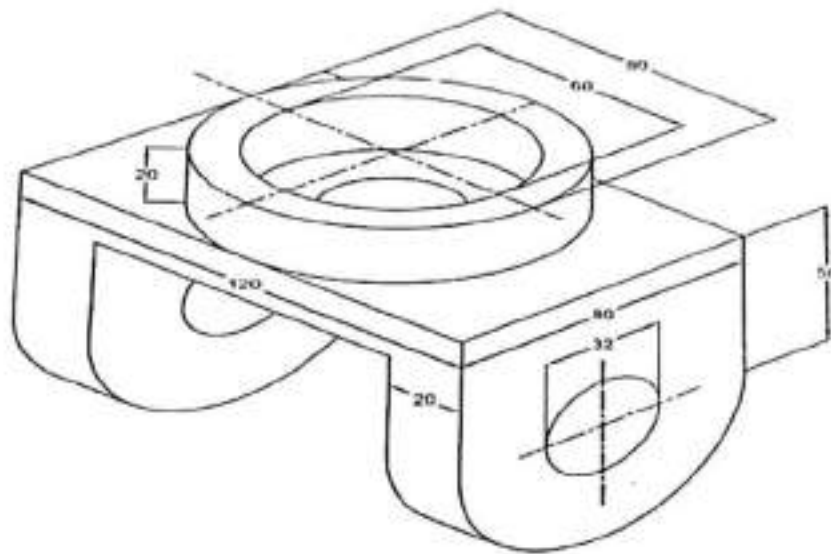

2. Draw the given 2D model into 3D model by using Catia.

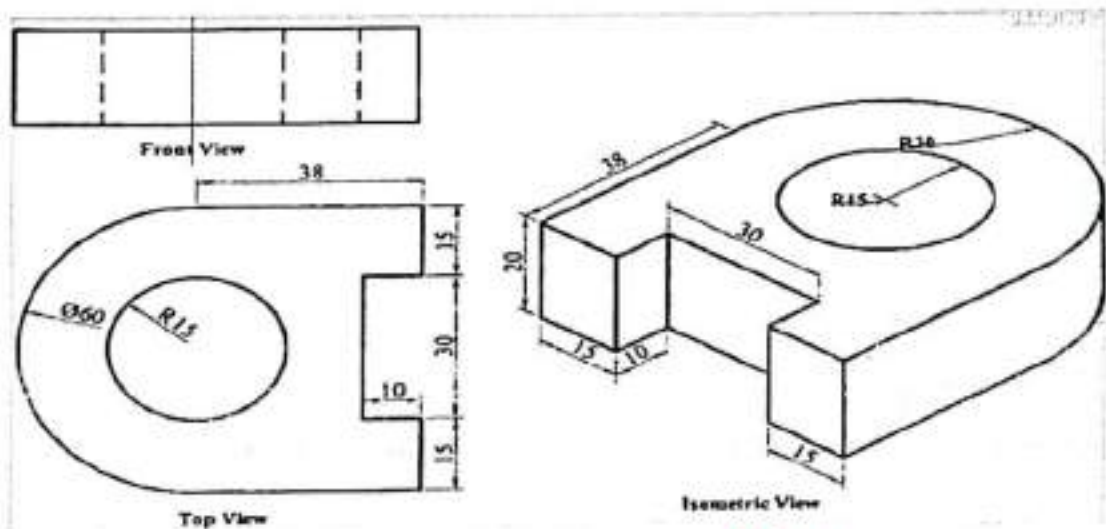



Department of Mechanical Engineering
CATIA Technical Training student Marks list 2017-18

Sl.NO	Roll No	Name of the student	YEAR	MARKS	PASS/FAIL
1	15E31A0301	ABDUL ABRAR	III	15	PASS
2	15E31A0302	ABDUL RAHMAN	III	16	PASS
3	15E31A0303	ANAND KUMAR	III	14	PASS
4	15E31A0304	AQUEEB UDDIN FIRDUSHI	III	15	PASS
5	15E31A0305	ATTLURI SURESH REDDY	III	17	PASS
6	15E31A0306	BANDA SATYA SHIVA REDDY	III	15	PASS
7	15E31A0310	BHOOMENI NARENDHAR	III	16	PASS
8	15E31A0311	BICHKUNDA SUNIL KUMAR	III	16	PASS
9	15E31A0313	CHIDIRALA RAJKUMAR	III	15	PASS
10	15E31A0315	DESHAGOUNI MOHAN SAI	III	15	PASS
11	15E31A0317	GURRALA VENKATA NARSI REDDY	III	16	PASS
12	15E31A0318	HUSSAIN FAIZ ULLAH	III	14	PASS
13	15E31A0319	K SAMPATH	III	15	PASS
14	15E31A0320	KASIREDDY SAIMANOJ REDDY	III	15	PASS
15	15E31A0321	KATTA SRIKANTH REDDY	III	16	PASS
16	15E31A0322	KESHETTI NIKHIL	III	14	PASS
17	15E31A0325	M A LATEEF	III	15	PASS
18	15E31A0327	MANCHIKANTI ARAVIND REDDY	III	17	PASS
19	15E31A0329	MD UBED UL RAHMAN	III	15	PASS
20	15E31A0331	MOHAMMED ABDULLAH ZUBAIR	III	16	PASS
21	15E31A0332	MOHAMMED AIJAZ	III	16	PASS
22	15E31A0333	MOHAMMED ISMAIL FURQAN	III	15	PASS
23	15E31A0334	MOHD ABDUL ATIF	III	16	PASS

K. Sub.

Principal
Mahaveer Institute of Technology
Vysapuri, Bandlaguda Post Keshavnagar,
Hyderabad-500 005, Telangana INDIA

Vysapuri, Bandlaguda Post Keshavnagar,
Hyderabad-500 005, Telangana INDIA
Tel: 040-64555579, 20020773, Fax: 040-24455003
E-mail: principal.mahaveer@gmail.com
Website: www.mist.ac.in

MAHAVEER



Approved by AICTE, Affiliated to JNTUH Hyd

24	15E31A0336	MOHD ASIM KHAN	III	14	PASS
25	15E31A0337	MOHD FARHAN AHMED SHAREEF	III	15	PASS
26	15E31A0338	MOHD SALA UDDIN	III	15	PASS
27	15E31A0340	MOHD TALHA	III	16	PASS
28	15E31A0341	MUDAVATH SRINIVAS	III	14	PASS
29	15E31A0342	NELLURI AJAY KUMAR	III	16	PASS
30	15E31A0343	PADAMATINI AVINASH	III	15	PASS
31	15E31A0344	PALNATI SRIKANTH REDDY	III	14	PASS
32	15E31A0346	POLAKA PARDHA SARADHI REDDY	III	18	PASS
33	15E31A0349	SABHAVAT SEVYA	III	15	PASS
34	15E31A0350	SHADMAN ASHRAF	III	16	PASS
35	15E31A0351	SHAIK ABDUL SAIF	III	15	PASS
36	15E31A0352	SHAIK ARIF HUSSAIN	III	16	PASS
37	15E31A0354	SOHAIL MOHAMMED MASOOD AHMED KHAN	III	15	PASS
38	15E31A0356	SYED BAHAUDDIN	III	16	PASS
39	15E31A0360	SYED QAMAR UDDIN RAZA SHAH QUADRI	III	15	PASS
40	15E31A0361	SYED SHAHED AHMED	III	14	PASS
41	15E31A0362	T KULDEEP SINGH	III	18	PASS
42	15E31A0363	TANNEERU RAJA	III	15	PASS
43	15E31A0365	VANGAPALLY SRINIVAS	III	16	PASS
44	16E35A0301	AMAR BIRADAR	III	16	PASS
45	16E35A0302	BHUKYA RAMA	III	15	PASS
46	16E35A0303	DHARAVATH RAVINDER NAYAK	III	14	PASS
47	16E35A0304	EROJI SURESH	III	18	PASS
48	16E35A0305	GOURAV KUMAR JHA	III	15	PASS
49	16E35A0306	KALIKOTA SAI CHARAN	III	16	PASS

Kan
Principal
MAHAVEER
INSTITUTE OF MANAGEMENT STUDIES & TECHNOLOGY
Bandlaguda 408, Hyd-500 005.

Vysapuri, Bandlaguda Post Keshavnagar,
Hyderabad-500 005, Telangana INDIA
Tel: 040-64201979,20020713, Fax: 040-24455003
E-mail: principal.mahaveer@gmail.com
Website: www.mvt.ac.in

MAHAVEER



Approved by AICTE, AMRATODDAR, JNTUHYD

50	16E35A0307	MANYALA SAHJJA	III	15	PASS
51	16E35A0308	TADEMBHARATHI KUMAR	III	16	PASS
52	16E35A0310	TANGELLA ASHOKA VARDHAN RAJU	III	15	PASS
53	14E31A0303	ANSAR AHMED KHAN	III	16	PASS
54	14E31A0334	MOHAMMED ABRAR AHMED	III	15	PASS
55	14E31A0335	MOHAMMED AKIF AHMED	III	14	PASS
56	14E31A0373	G KARTHIK RAJ	III	18	PASS
57	14E31A0374	A KAUSHIK VILAS	III	15	PASS
58	14E31A0386	MOHAMMED SOHAIB	III	16	PASS
59	14E31A0397	SYED SIKANDER ALI	III	15	PASS
60	14E31A0398	SYED VIKAYAT ULLAH	III	16	PASS
61	15E35A0301	E MADHUKAR	III	15	PASS
62	13E31A0304	AKASH HANVETH	III	16	PASS
63	14E31A0390	RAHUL SINGH	III	15	PASS
64	14E31A0376	IMAMD HASAN KHAN	III	14	PASS
65	14E31A0359	TAMMARASHI AJAY KUMAR	III	18	PASS
66	13E31A0350	S KUNAL	III	15	PASS
67	14E31A0341	MOHD KHAHA MOHIUDDIN	III	16	PASS
68	14E31A0352	SAIFULLAH EKARAN JALKOTE	III	16	PASS
69	14E31A0337	MOHD ADNAN AZHAR	III	15	PASS
70	14E31A0339	MOHD ABDUL HAMEED GOURI	III	14	PASS

K. Sankar
PRINCIPAL
MAHAVEER
INSTITUTE OF MANAGEMENT & TECHNOLOGY
Bandlaguda, Hyd-500 005.



CATIA COURSE Summary

- In this course, you will learn how to utilize the core functionality enhancements in Catia.
- First, you will become familiar with using and customizing the new ribbon interface in Catia.
- The new measure and sectioning interfaces will also be examined. Next, you will become familiar with the Sketcher workflow and reference enhancements.
- Part modeling enhancements to features such as Extrude, Corner Chamfer, Sweeps, Blends, and Datum Curves will then be examined.
- You will also learn about new and enhanced Assembly capabilities, such as selecting multiple components, the new relationship constraints, and enhancements for dragging components.
- Then, you will examine the new Table and Balloon functionality for 2-D drawings, and review various detailing enhancements.
- At the end of each module, you will complete a set of review questions to reinforce critical topics from that module. At the end of the course, you will complete a course assessment in Catia intended to evaluate your understanding of the course as a whole.

Copy to :

1. Department of Notice Board
2. Principal for Information
3. Committee Members (Academic)

MAHAVEER
INSTITUTE OF SCIENCE & TECHNOLOGY
Bandlaguda, Hyd-500 005.

Vysapuri, Bandlaguda Post-Keshavnagar,
Hyderabad-500 005, Telangana INDIA
Tel: 040 64596979, 20020773, Fax: 040 24455003
E-mail: principal.mahaveer@gmail.com,
Website: www.mist.ac.in

MAHAVEER

INSTITUTE OF SCIENCE & TECHNOLOGY
Approved by AICTE, Affiliated to JNTUH, Hyd



CERTIFICATE OF COURSE COMPLETION

This certificate is presented to T. Raja of
MIST, who has successfully completed technical training course on
"CATIA" held from 02-05-2017 to 12-05-2017 and found the
student performance to be excellent.



ESTD : 2001

Dr. S. Murali

HOD

Department of Mechanical Engineering

K. S. S. S.

M. S. S. S. S.
INSTITUTE OF SCIENCE & TECHNOLOGY
Bandlaguda, Hyd-500 005.



DEPARTMENT OF MECHANICAL ENGINEERING

List of students enrolled in CATIA (2017-2018)

S.No	Roll No	Name of the student	21/5/17	21/5	4/5	5/5	6/5	8/5	7/5	10/5	11/5	12/5
1	15E31A0301	ABDUL ABRAR	P	P	P	P	P	P	P	P	P	P
2	15E31A0302	ABDUL RAHMAN	P	P	P	P	P	P	P	P	P	P
3	15E31A0303	ANAND KUMAR	P	P	P	P	P	P	P	P	P	P
4	15E31A0304	AQUEEB UDDIN FIRDUSH	P	P	P	P	P	P	P	P	P	P
5	15E31A0305	ATTLURI SURESH REDDY	P	P	P	P	P	P	P	P	P	P
6	15E31A0306	BANDA SATYA SHIVA REDDY	P	P	P	P	P	P	P	P	P	P
7	15E31A0310	BHOOMENI NARENDHAR	P	P	P	P	P	P	P	P	P	P
8	15E31A0311	BICHKUNDA SUNIL KUMAR	P	P	P	P	P	P	P	P	P	P
9	15E31A0313	CHIDIRALA RAJKUMAR	P	P	P	P	P	P	P	P	P	P
10	15E31A0315	DESHAGOUNI MOHAN SAI	P	P	P	P	P	P	P	P	P	P
11	15E31A0317	GURRALA VENKATA NARSI REDDY	P	P	P	P	P	P	P	P	P	P
12	15E31A0318	HUSSAIN FAIZ ULLAH	P	P	P	P	P	P	P	P	P	P
13	15E31A0319	K SAMPATH	P	P	P	P	P	P	P	P	P	P
14	15E31A0320	K SAIMANOJ REDDY	P	P	P	P	P	P	P	P	P	P
15	15E31A0321	KATTA SRIKANTH REDDY	P	P	P	P	P	P	P	P	P	P
16	15E31A0322	KESHETTI NIKHIL	P	P	P	P	P	P	P	P	P	P
17	15E31A0325	M A LATEEF	P	P	P	P	P	P	P	P	P	P

Rohit
PRINCIPAL

10/11/17



DEPARTMENT OF MECHANICAL ENGINEERING

List of students enrolled in CATIA (2017-2018)

18	15E31A0327	MANCHIKANTH ARAVIND	P	P	P	P	P	P	P	P	P	P
19	15E31A0329	MD UBED UL RAHMAN	P	P	P	P	P	P	P	P	P	P
20	15E31A0331	MOHAMMED ABDULLAH ZUBAIR	P	P	P	P	P	P	P	P	P	P
21	15E31A0332	MOHAMMED ALI AZ	P	P	P	P	P	P	P	P	P	P
22	15E31A0333	MOHAMMED ISMAHIL FURQAN	P	P	P	P	P	P	P	P	P	P
23	15E31A0334	MOHD ABDUL ATHI	P	P	P	P	P	P	P	P	P	P
24	15E31A0336	MOHD ASIM KILAN	P	P	P	P	P	P	P	P	P	P
25	15E31A0337	MOHD FARHAN AHMED SHAREEF	P	P	P	P	P	P	P	P	P	P
26	15E31A0338	MOHD SALA UDDIN	P	P	P	P	P	P	P	P	P	P
27	15E31A0340	MOHD TALHA	P	P	P	P	P	P	P	P	P	P
28	15E31A0341	MUDAVATH SRINIVAS	P	P	P	P	P	P	P	P	P	P
29	15E31A0342	NELLURI AJAY KUMAR	P	P	P	P	P	P	P	P	P	P
30	15E31A0343	PADAMATINTI LAVINASHI	P	P	P	P	P	P	P	P	P	P
31	15E31A0344	PALNATI SRIKANTH REDDY	P	P	P	P	P	P	P	P	P	P
32	15E31A0346	P PARDHA SARATHI	P	P	P	P	P	P	P	P	P	P
33	15E31A0349	SABHAVAT SEVYA	P	P	P	P	P	P	P	P	P	P
34	15E31A0350	SHADMAN ASHRAF	P	P	P	P	P	P	P	P	P	P
35	15E31A0351	SHAIK ABDUL SAIF	P	P	P	P	P	P	P	P	P	P



DEPARTMENT OF MECHANICAL ENGINEERING

List of students enrolled in CATIA (2017-2018)

55	14E31A0335	MOHAMMED AKH AHMED	P	P	P	P	P	P	P	P	P	P
56	14E31A0373	G KARTHIK RAJ	P	P	P	P	P	P	P	P	P	P
57	14E31A0374	A KAUSHIK VILAS	P	P	P	P	P	P	P	P	P	P
58	14E31A0386	MOHAMMED SOHAM	P	P	P	P	P	P	P	P	P	P
59	14E31A0397	SYED SIKANDER ALI	P	P	P	P	P	P	P	P	P	P
60	14E31A0398	SYED VIKAYAT ULLAH	P	P	P	P	P	P	P	P	P	P
61	15E35A0301	E MADHUKAR	P	P	P	P	P	P	P	P	P	P
62	13E31A0304	AKASH HANVETHI	P	P	P	P	P	P	P	P	P	P
63	14E31A0390	RAHUL SINGH	P	P	P	P	P	P	P	P	P	P
64	14E31A0376	IMAMD HASAN KHAN	P	P	P	P	P	P	P	P	P	P
65	14E31A0359	TAMMARASHI AJAY KUMAR	P	P	P	P	P	P	P	P	P	P
66	13E31A0350	S KUNAL	P	P	P	P	P	P	P	P	P	P
67	14E31A0341	MOHD KHAHA MOHUDDIN	P	P	P	P	P	P	P	P	P	P
68	14E31A0352	SAIFULLAH EKRAN JALKOTE	P	P	P	P	P	P	P	P	P	P
69	14E31A0337	MOHD ADNAN AZHAR	P	P	P	P	P	P	P	P	P	P
70	14E31A0339	MOHD ABDUL HAMEED GOURI	P	P	P	P	P	P	P	P	P	P



About the College

As an Institute committed in quality education, MIST aims at providing learning with a Technology-edge. It endeavors to provide consistent training to its students to help them evolve as competent professionals in the highly competitive world. Right from its inception in 2001, it has been tuning itself to meet this objective. A new civilization is emerging in our lives. This civilization brings with it a new way of working. Millions are already tuning their lives to the rhythms of tomorrow.

About Mechanical Dept.

The Mechanical engineering is one of the core engineering departments, which has potential to accommodate all efficient engineers. The Mechanical engineers serve all other branches of engineering directly or indirectly. The Mechanical engineers can find their place in Automobile engineering sector, Steel Plants, Power plants, Software industries, Manufacturing industries, Design industries, Military, Naval and Air force, Defense research organizations, Material research organizations etc.

About the Workshop

The course builds from the big ideas in finite element analysis and computational fluid dynamics to ANSYS case studies that progress from real world applications and examples. ANSYS is the flagship engineering software solution that uses finite element analysis (FEA), which is a numerical and computational method used to solve the real engineering problems related to physics, structural analysis, heat transfer, fluid flow, mass transport, and electromagnetic potential field. To solve the problem, it subdivides a large problem into smaller, simpler parts that are called finite elements and solve the problem by minimizing an associated error function.

Organising committee

CHIEF PATRON

Sri.S.Sudershan Reddy
Chairman

Sri. S. Surendar Reddy
Secretary

Sri S. Dhanunjay Reddy
Joint Secretary

DIRECTOR

Dr. H. S. N. Murthy

PATRON

Dr.S.S.S.N.Reddy,Principal

CONVENER

Dr.S.Murali,
Professor,Dept. Of Mechanical

PROGRAM COORDINATORS

G.K.Shanmukh Dev

Conducted On

02/05/2017- 12/05/2017



MAHAVEER

INSTITUTE OF SCIENCE & TECHNOLOGY

Approved by AICTE, Affiliated to JNTU, Hyderabad.

Vyasapuri, Bandlaguda, Post: Keshavnagar, Hyderabad-500005.

ANSYS®

**Two week
Certification Course
on**

ANSYS

Organized by

*Department of Mechanical
Engineering*

Vysaguri, Bandlaguda Post, Keshavnagar,
Hyderabad-500 605, Telangana INDIA
Tel: 040-44596979, 20020771, Fax: 040-24455003
E-mail: principal.mahaveer@gmail.com
Website: www.mist.ac.in

MAHAVEER



Approved by AICTE Affiliated to JNTU, Hyd

Date: 01.05.2017

CIRCULAR

Technical Training for IV B. Tech students are starting from 2nd MAY, 2017 onwards. All HODs and Placements coordinators have to manage the trainings and ensure 95% attendance all through the sessions.

All Mentors need to send the compiled feedback report to Dr.S.Murali, HOD at e3hod.mech@gmail.com daily.

Agenda: 1. Introduction to ANSYS.

Design and Development of curriculum for Add on course:

Name of the Faculty : G.K.Shanmukh Dev

PRINCIPAL
MAHAVEER
INSTITUTE OF SCIENCE & TECHNOLOGY
BANDLAGUDA, HYD-500 605

Dr.S.Murali

HOD

Department of Mechanical Engineering

Vysapuri, Bandlaguda Post, Keshavnagar,
Hyderabad-500 005, Telangana INDIA
Tel: 040-64556979, 20820773, Fax: 040-24455003
E-mail: principal.mahaveer@gmail.com,
Website: www.mist.ac.in,

MAHAVEER



Approved by AICTE, Affiliated to JNTUHH, Hyd

Date: 29-04-2017

To
The Principal
MIST,
Hyderabad.

Sub: Proposal for Add-on Course-Reg.

Respected sir,

We are going to conduct 10 days Technical Training for IV B. Tech students on "Introduction to Ansys". We require your approval to go head for proceeding and hope to get an opportunity to serve you the best.

With thanks and regards

PRINCIPAL
MAHAVEER
INSTITUTE OF SCIENCE & TECHNOLOGY
BANDLAGUDA, HYD-500 005.

Dr.S.Murali

HOD

Department of Mechanical Engineering

Vysapuri, Bandlaguda Post Keshavnagar,
Hyderabad 500 805, Telangana INDIA
Tel: 040-64596979, 20620773, Fax: 040-24455003
E-mail: principal.mahaveer@gmail.com
Website: www.mahaveer.ac.in

MAHAVEER



Approved by AICTE Affiliated to JNTU, Hyderabad

ANSYS SYLLABUS

S.NO	TOPIC COVERED	DURATION (Hours)
1	INTRODUCTION TO FEA AND	3
2	BASIC SOLID MODELING	3
3	ADVANCED SOLID MODELING	3
4	FINITE ELEMENT MODELING (FEM) – I	3
5	FINITE ELEMENT MODELING (FEM) – II	3
6	SOLUTION AND POSTPROCESSOR	3
7	STATIC STRUCTURAL ANALYSIS	3
8	ADVANCED STRUCTURAL ANALYSIS (DYNAMIC AND NONLINEAR)	3
9	ADVANCED STRUCTURAL ANALYSIS	2
10	THERMAL ANALYSIS	2
11	GENERATING THE REPORT OF ANALYSIS	2

PRINCIPAL
M. MAHAVEER
15/11/2023
Principal Mahaveer Institute of Technology



Department of Mechanical Engineering ANSYS Technical Training student attendance list 2017-2018

S.NO.	ROLL NO.	NAME OF THE STUDENT	YEAR
1	14E31A0301	ALLI ARAVIND	IV
2	14E31A0302	ANNAPU PUSHPANJALI	IV
3	14E31A0306	B KISHORE	IV
4	14E31A0307	B VISHNU	IV
5	14E31A0308	BALUSA VIVEK	IV
6	14E31A0309	BOTTU SAI MUKUND	IV
7	14E31A0310	C SAI KIRAN	IV
8	14E31A0311	CHINTHIRALA NAGARJUNA	IV
9	14E31A0313	DUDUKA SHIVAKUMAR	IV
10	14E31A0314	DUSA YASHWANTHI	IV
11	14E31A0315	EPPA RAGHU	IV
12	14E31A0316	ESUNATHI KALYAN	IV
13	14E31A0317	GANGULA VINAY KUMAR REDDY	IV
14	14E31A0318	GOPIJI ABHINAV REDDY	IV
15	14E31A0319	GORIGE RAVIKANTHI	IV
16	14E31A0320	GOWLIKAR BHARGAV KUMAR	IV
17	14E31A0321	JADALA VAMSHI KRISHNA	IV
18	14E31A0322	JITENDRA SINGH	IV
19	14E31A0323	KATAPAAGA NIKHIL KALYAN	IV
20	14E31A0325	KASOJU SAI KIRAN	IV
21	14E31A0326	KATAKAM VINODKUMAR	IV
22	14E31A0327	YAMINI SAI KUMAR	IV

Vysapuri, Bandlaguda Post Keshavnagar,
Hyderabad-500 005, Telangana INDIA
Tel: 040-64596979,20020773, Fax: 040-24455003
E-mail: principal.mahaveer@gmail.com
Website: www.mist.ac.in,

MAHAVEER



Approved by AICTE Affiliated to JNTUHHyd

23	14E31A0328	KOTTALA SUSUMITHA	IV
24	14E31A0329	KUCHANPALLY SANTHOSH REDDY	IV
25	14E31A0330	MADDIBOENA SIVAPRAGATHILAKSHMI	IV
26	14E31A0331	MAMMA AKHILESH	IV
27	14E31A0333	MEDI AKHIL	IV
28	14E31A0338	MOHAMMED KHAN	IV
29	14E31A0340	MOHD ADJAZ KHAN	IV
30	14E31A0343	MOTHAJIGARI VIJAY	IV
31	14E31A0346	MUPPARAM SADHANA	IV
32	14E31A0347	NEELI AKASH	IV
33	14E31A0348	P KRISHNA	IV
34	14E31A0349	PALATI RUKMANGADUDU	IV
35	14E31A0353	SHAIK AQIB	IV
36	14E31A0354	SHAIK MOHAMMED RAYAN	IV
37	14E31A0355	SHAIK SOHAIL	IV
38	14E31A0358	SYED MUZAMEEL ALI	IV
39	14E31A0360	VADLA PRASHANTH	IV
40	14E31A0361	AMIT KUMAR PANDEY	IV
41	14E31A0363	ARROJU SHRAVANKUMAR	IV
42	14E31A0365	BONMARAJU SAIKUMAR	IV
43	14E31A0367	FAZAL AHMED KAMIL	IV
44	14E31A0369	G RAGHUVERDHAN REDDY	IV
45	14E31A0372	GORIGE NARENDER	IV
46	14E31A0377	JAMALPUR ADITHYA	IV
47	14E31A0378	KADAVENDI ARAVIND	IV
48	14E31A0380	KOPPULA NARESH REDDY	IV

Kishu
PRINCIPAL
MAHAVEER
Vysapuri, Bandlaguda Post Keshavnagar,
Hyderabad-500 005, Telangana INDIA

Vysapuri, Bandlaguda Post, Keshavnagar,
Hyderabad-500 005, Telangana INDIA
Tel: 040-64556979, 20020773, Fax: 040-24455003
E-mail: principal.mahaveer@gmail.com
Website: www.mst.ac.in

MAHAVEER



Approved by AICTE. Affiliated to JNTU HVT

49	14E31A0382	MA RAHEMAN	IV
50	14E31A0383	MD MUQTAR AHMED KHAN	IV
51	14E31A0384	MOHAMMED ABDUL RAHEMAN	IV
52	14E31A0385	MOHAMMED OMER	IV
53	14E31A0387	MOHAMMED AKBAR	IV
54	14E31A0388	MOHD FAROOQ	IV
55	14E31A0389	MOHD SOHAIL	IV
56	14E31A0391	N VINESH REDDY	IV
57	14E31A0392	NANDIGAM SURENDRA	IV
58	14E31A0393	PITLA SWAMY	IV
59	14E31A0396	RINJU GEORGE	IV
60	14E31A03A0	VADLURI KRISHNA	IV
61	14E31A03A1	YERRA ARVIND REDDY	IV
62	14E31A03A2	SHEOB AHMED	IV
63	14E31A03A3	SYED MD AHMED MOHIUDDIN QUADRI	IV
64	13E31A0380	MOHD FARHAN UDDIN	IV
65	15E35A0302	HAKHILESH	IV
66	15E35A0303	HEEREKAR RAHUL	IV
67	15E35A0304	MAMDIGA NAGESH	IV
68	15E35A0305	MD SHOEB AKRAM	IV
69	15E35A0307	MYAKALA SHIVAKUMAR	IV
70	15E35A0308	SYED ASHFAQ	IV
71	13E31A0318	C VENKATESH	IV

Kishor!
MAHAVEER
11/11/2019
11/11/2019



Technical Training Exam on ANSYS Software (A.Y-2017-2018)

2x10=20 Marks

Answer All the Questions

1.

Given the 2D truss structure represented in Figure 1.1, where:

- $h = 5 \text{ m}$
- $L = 5 \text{ m}$
- $E = 1000 \text{ N}$
- $E = 1.0 \times 10^5 \text{ N/m}^2$ (Young's modulus)
- $A = 0.1 \text{ m}^2$ (Cross-section area of each beam element)

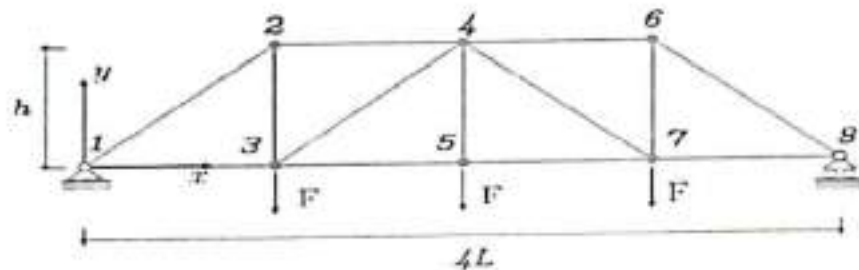

Figure 1.1: Example truss structure, constraints and loads.

2.

- 7.13 Determine the stresses in the plate with the hole subjected to the tensile stress shown in Figure P7-13. Graph the stress variation σ_x versus the distance y from the hole. Let $E = 200 \text{ GPa}$, $\nu = 0.25$, and $r = 25 \text{ mm}$. (Use various mesh densities, depending on your computer program in your finite element model.) Use symmetry as appropriate.



Figure P7-13

Handwritten signature
 P. S. R. MAHAVEER
 IASIT
 Bandlaguda, P.O. 500 025.



Department of Mechanical Engineering					
ANSYS Technical Training student attendance list 2017-2018					
S.NO	Roll No	Name of the student	YEAR	MARKS	PASS/FAIL
1	14E31A0301	ALLI ARAVIND	IV	15	PASS
2	14E31A0302	ANNAPU PUSHPANJALI	IV	16	PASS
3	14E31A0306	B KISHORE	IV	18	PASS
4	14E31A0307	B VISHNU	IV	15	PASS
5	14E31A0308	BALUSA VIVEK	IV	15	PASS
6	14E31A0309	BOTTU SAI MUKUND	IV	15	PASS
7	14E31A0310	C SAI KIRAN	IV	16	PASS
8	14E31A0311	CHINTHIRALA NAGARJUNA	IV	15	PASS
9	14E31A0313	DUDUKA SHIVAKUMAR	IV	16	PASS
10	14E31A0314	DUSA YASHWANTH	IV	12	PASS
11	14E31A0315	EPPA RAGHU	IV	15	PASS
12	14E31A0316	ESUNATHI KALYAN	IV	16	PASS
13	14E31A0317	GANGULA VINAY KUMAR REDDY	IV	12	PASS
14	14E31A0318	GOPIDI ABHINAV REDDY	IV	15	PASS
15	14E31A0319	GORIGE RAVIKANTH	IV	16	PASS
16	14E31A0320	GOWTIKAR BHARGAV KUMAR	IV	14	PASS
17	14E31A0321	JADALA VAMSHI KRISHNA	IV	15	PASS
18	14E31A0322	JITENDRA SINGH	IV	17	PASS
19	14E31A0323	KATAPAAGA NIKHIL KALYAN	IV	15	PASS
20	14E31A0325	KASOJU SAI KIRAN	IV	16	PASS
21	14E31A0326	KATAKAM VINODKUMAR	IV	16	PASS
22	14E31A0327	YAMINI SAI KUMAR	IV	15	PASS
23	14E31A0328	KOTTALA SUSHIMITHA	IV	16	PASS

Vysapuri, Bandlaguda Post Keshavnagar,
Hyderabad 500 055, Telangana INDIA
Tel: 040-44534979, 20020773, Fax: 040-24455003
E-mail: principal.mahaveer@gmail.com
Website: www.must.ac.in

MAHAVEER



Approved by AICTE, Affiliated to JNTUHY Hydr

24	14E31A0329	KUCHANPALLY SANTHOSH REDDY	IV	14	PASS
25	14E31A0330	MADDIBOENA SIVAPRAGATHILAKSHMI	IV	15	PASS
26	14E31A0331	MAMMAIAKHILESH	IV	15	PASS
27	14E31A0333	MEDI AKHIL	IV	16	PASS
28	14E31A0338	MOHAMMED KHAN	IV	14	PASS
29	14E31A0340	MOHD AJAZ KHAN	IV	15	PASS
30	14E31A0343	MOTHAJIGARI VIJAY	IV	15	PASS
31	14E31A0346	MUPPARAM SADHANA	IV	14	PASS
32	14E31A0347	NEELI AKASHI	IV	16	PASS
33	14E31A0348	P KRISHNA	IV	16	PASS
34	14E31A0349	PALATI RUKMANGADUDU	IV	14	PASS
35	14E31A0353	SHAIK AQIB	IV	15	PASS
36	14E31A0354	SHAIK MOHAMMED RAYAN	IV	16	PASS
37	14E31A0355	SHAIK SOHAIL	IV	15	PASS
38	14E31A0358	SYED MUZAMEEL ALI	IV	16	PASS
39	14E31A0360	VADLA PRASHANTH	IV	14	PASS
40	14E31A0361	AMIT KUMAR PANDEY	IV	12	PASS
41	14E31A0363	ARROJU SHRAVANKUMAR	IV	15	PASS
42	14E31A0365	BOMMARAJU SAIKUMAR	IV	16	PASS
43	14E31A0367	FAZAL AHMED KAMIL	IV	15	PASS
44	14E31A0369	G RAGHUVERDIHAN REDDY	IV	16	PASS
45	14E31A0372	GORIGE NARENDER	IV	15	PASS
46	14E31A0377	JAMALPUR ADITHYA	IV	14	PASS
47	14E31A0378	KADAVENDI ARAVIND	IV	18	PASS
48	14E31A0380	KOPPULA NARESH REDDY	IV	15	PASS

Kavya
MAHAVEER
VEER
111-1111111111
30/11/2024

Vysapuri, Bandlaguda Post Keshavnagar,
Hyderabad 500 005, Telangana INDIA
Tel: 040-64516919, 20020773, Fax: 040-24455003
E-mail: principal.mahaveer@gmail.com
Website: www.must.ac.in

MAHAVEER



Approved by AICTE. Affiliated to JNTU(H)Hyd

49	14E31A0382	MA RAHEMAN	IV	16	PASS
50	14E31A0383	MD MUQTAR AHMED KHAN	IV	15	PASS
51	14E31A0384	MOHAMMED ABDUL RAHEMAN	IV	16	PASS
52	14E31A0385	MOHAMMED OMER	IV	15	PASS
53	14E31A0387	MOHAMMED AKBAR	IV	16	PASS
54	14E31A0388	MOHD FAROOQ	IV	14	PASS
55	14E31A0389	MOHD SOHAIL	IV	12	PASS
56	14E31A0391	N VINESH REDDY	IV	15	PASS
57	14E31A0392	NANDIGAM SURENDRA	IV	16	PASS
58	14E31A0393	PITLA SWAMY	IV	15	PASS
59	14E31A0396	RINJU GEORGE	IV	16	PASS
60	14E31A03A0	VADLURI KRISHNA	IV	15	PASS
61	14E31A03A1	YERRA ARVIND REDDY	IV	14	PASS
62	14E31A03A2	SHEOB AHMED	IV	18	PASS
63	14E31A03A3	SYED MD AHMED MOHIUDDIN QUADRI	IV	15	PASS
64	13E31A0380	MOHD FARHAN UDDIN	IV	16	PASS
65	15E35A0302	H AKHILESH	IV	15	PASS
66	15E35A0303	HIREKAR RAHUL	IV	15	PASS
67	15E35A0304	MAMIDIGA NAGESH	IV	16	PASS
68	15E35A0305	MD SHOEB AKRAM	IV	18	PASS
69	15E35A0307	MYAKALA SHIVAKUMAR	IV	17	PASS
70	15E35A0308	SYED ASHFAQ	IV	16	PASS
71	13E31A0318	C VENKATESH	IV	17	PASS

(Handwritten signature)

PRINCIPAL
MAHAVEER
KESHAVNAGAR
BANDLAGUDA POST
VYSAPURI, HYDERABAD



ANSYS COURSE

Summary

Department of Mechanical Engineering

1. The Geometry preparation training course is for users who want to create and modify geometry in preparation for CFD or FEA analysis. The training will be focused in either ANSYS Design Modeler or ANSYS SpaceClaim.

2. The ANSYS Meshing training course will give you the tools for generating good quality meshes for Fluent and CFX. The trainee will choose which tool should be used: ANSYS Meshing, Fluent Meshing or ICEM CFD.

3. This course will show how to set up a range of simulation types in the ANSYS Fluent or ANSYS CFX solver, as well as how to post process the results by using our CFD Post Tool.

4. This course will show how to set up a range of simulation types in ANSYS Mechanical, as well as how to post process and evaluate your results.

5. To acquire advance knowledge to perform explicit simulations with ANSYS Explicit STR, ANSYS AUTODYN or ANSYS LS-DYNA.

6. This is an introductory to intermediate level training for using ANSYS HFSS for all applications, like RF/microwave, antennas or planar problems. Participants will get understanding of HFSS modeling, solution process and post-processing features, which can be used for other advanced applications. The course will also cover advanced topics like dynamic link between EM and circuit, impedance matching, overview of HFSS 3D layout interface and speeding-up HFSS simulation using HPC.

7. Provide the needed tools for the complete simulation of a pressure Vessel from scratch. Several types of analysis and boundary conditions will be discussed, by using pressure vessels examples.

8. To acquire advance knowledge for performing mechanical simulation in Fixed Offshore Structures.

Copy to :

1. Department of Notice Board
2. Principal for Information
3. Committee Members (Academic)

Venugopal, Bandlaguda Post, Kothagudem,
Hyderabad - 504 501, Telangana (INDIA)
Tel: 040-84588973/2004073 Fax: 040-24155103
E-mail: group.principal@mahaveer.com
Website: www.mahaveer.com

MAHAVEER

Approved by AICTE, All India Institute of Technology



CERTIFICATE OF COURSE COMPLETION

This certificate is presented to C.Venkatesh of
MIST, who has successfully completed technical training course on
"ANSYS" held from 02-05-2017 to 12-05-2017 and found the
student performance to be excellent.

Kishor
PRINCIPAL
MAHAVEER
INSTITUTE OF SCIENCE & TECHNOLOGY
BANDLAGUDA, HYD-504 501



ESTD : 2001

Dr. M. V. S. Reddy
HOD

Department of Mechanical Engineering



DEPARTMENT OF MECHANICAL ENGINEERING

List of students enrolled in ANSYS (2017-2018)

S.No	Roll No	Date	25/11	3/5	4/5	5/5	6/5	8/5	9/5	10/5	11/5	12/5
1	14E31A0301	ALLI ARAVIND	P	P	P	P	P	P	P	P	P	P
2	14E31A0302	ANNAPU PUSHPANJALI	P	P	P	P	P	P	P	P	P	P
3	14E31A0306	B KISHORE	P	P	P	P	P	P	P	P	P	P
4	14E31A0307	B VISHNU	P	P	P	P	P	P	P	P	P	P
5	14E31A0308	BALUSA VIVEK	P	P	P	P	P	P	P	P	P	P
6	14E31A0309	BOTTU SAI MUKUND	P	P	P	P	P	P	P	P	P	P
7	14E31A0310	C SAI KIRAN	P	P	P	P	P	P	P	P	P	P
8	14E31A0311	CHINTHIRALA N. ARJUNA	P	P	P	P	P	P	P	P	P	P
9	14E31A0313	DUDUKA SHIVAKUMAR	P	P	P	P	P	P	P	P	P	P
10	14E31A0314	DUSA YASHWANTHI	P	P	P	P	P	P	P	P	P	P
11	14E31A0315	EPPA RAGHU	P	P	P	P	P	P	P	P	P	P
12	14E31A0316	ESUNATHI KALYAN	P	P	P	P	P	P	P	P	P	P

Kishore
Principal
Mahaveer Institute of Technology
Hyderabad-500 005



DEPARTMENT OF MECHANICAL ENGINEERING

List of students enrolled in ANSYS (2017-2018)

13	14E31A0317	GANGULA VINAY KUMAR REDDY	P	P	P	P	P	P	P	P	P	P
14	14E31A0318	GOPIDI ABHINAV REDDY	P	P	P	P	P	P	P	P	P	P
15	14E31A0319	GORIGE RAVIKANTH	P	P	P	P	P	P	P	P	P	P
16	14E31A0320	GOWLIKAR BHARGAV KUMAR	P	P	P	P	P	P	P	P	P	P
17	14E31A0321	JADALA VAMSHI KRISHNA	P	P	P	P	P	P	P	P	P	P
18	14E31A0322	JITENDRA SINGH	P	P	P	P	P	P	P	P	P	P
19	14E31A0323	KATAPAAGA NIKHIL KALYAN	P	P	P	P	P	P	P	P	P	P
20	14E31A0325	KASOJU SAI KIRAN	P	P	P	P	P	P	P	P	P	P
21	14E31A0326	KATAKAM VINODKUMAR	P	P	P	P	P	P	P	P	P	P
22	14E31A0327	YAMINI SAI KUMAR	P	P	P	P	P	P	P	P	P	P
23	14E31A0328	KOTTALA SUSHMITHA	P	P	P	P	P	P	P	P	P	P
24	14E31A0329	KUCHANPALLY SANTHOSH REDDY	P	P	P	P	P	P	P	P	P	P
25	14E31A0330	MADDIBOENA SIVAPRAGATHI AKSHITHA	P	P	P	P	P	P	P	P	P	P

K. Srinivas
 PRINCIPAL
 MAHAVEER
 Institute of Technology & Engineering
 Bandlaguda, Hyderabad-500005



DEPARTMENT OF MECHANICAL ENGINEERING

List of students enrolled in ANSYS (2017-2018)

26	14E31A0331	MAMMA AKHIL SHI	P	P	P	P	P	P	P	P	P	P	P
27	14E31A0333	MEDI AKHIL	P	P	P	P	P	P	P	P	P	P	P
28	14E31A0338	MOHAMMED KHAN	P	P	P	P	P	P	P	P	P	P	P
29	14E31A0340	MOHD AJAZ KHAN	P	P	P	P	P	P	P	P	P	P	P
30	14E31A0343	MOTHAJGARI VIJAY	P	P	P	P	P	P	P	P	P	P	P
31	14E31A0346	MUPPARAM SADIYANA	P	P	P	P	P	P	P	P	P	P	P
32	14E31A0347	NEELI AKASH	P	P	P	P	P	P	P	P	P	P	P
33	14E31A0348	P KRISHNA	P	P	P	P	P	P	P	P	P	P	P
34	14E31A0349	PALATI RUKMANGADUDU	P	P	P	P	P	P	P	P	P	P	P
35	14E31A0353	SHAIK AQIB	P	P	P	P	P	P	P	P	P	P	P
36	14E31A0354	SHAIK MOHAMMED RAYAN	P	P	P	P	P	P	P	P	P	P	P
37	14E31A0355	SHAIK SOHAIL	P	P	P	P	P	P	P	P	P	P	P
38	14E31A0358	SYED MUZAMMEL ALI	P	P	P	P	P	P	P	P	P	P	P

Principal
Mahaveer Engineering College
Hyderabad-500 005



DEPARTMENT OF MECHANICAL ENGINEERING

List of students enrolled in ANSYS (2017-2018)

39	14E31A0360	VADLA PRASHANTH	P	P	P	P	P	P	P	P	P	P
40	14E31A0361	AMIT KUMAR PANDEY	P	P	P	P	P	P	P	P	P	P
41	14E31A0363	ARROJU SHRAVANKUMAR	P	P	P	P	P	P	P	P	P	P
42	14E31A0365	BOMMARAJU SAIKUMAR	P	P	P	P	P	P	P	P	P	P
43	14E31A0367	FAZAL AHMED KAMIL	P	P	P	P	P	P	P	P	P	P
44	14E31A0369	G RAGHUVERDHAN REDDY	P	P	P	P	P	P	P	P	P	P
45	14E31A0372	GORIGE NARENDER	P	P	P	P	P	P	P	P	P	P
46	14E31A0377	JAMALPUR ADITHYA	P	P	P	P	P	P	P	P	P	P
47	14E31A0378	KADAVENDI ARAVIND	P	P	P	P	P	P	P	P	P	P
48	14E31A0380	KOPPULA NARESH REDDY	P	P	P	P	P	P	P	P	P	P
49	14E31A0382	MA RAHEMAN	P	P	P	P	P	P	P	P	P	P
50	14E31A0383	MD MUQTAR AHMED KHAN	P	P	P	P	P	P	P	P	P	P
51	14E31A0384	MOHAMMED ABDUL RAHEMAN	P	P	P	P	P	P	P	P	P	P
52	14E31A0385	MOHAMMED OMER	P	P	P	P	P	P	P	P	P	P

Khanh

PRINCIPAL
MAHAVEER
Institute of Science & Technology
Bandlaguda, Hyderabad-500 005



DEPARTMENT OF MECHANICAL ENGINEERING

List of students enrolled in ANSYS (2017-2018)

53	14E31A0387	MOHAMMED AKIAR	P	P	P	P	P	P	P	P	P	P
54	14E31A0388	MOHD FAROOQ	P	P	P	P	P	P	P	P	P	P
55	14E31A0389	MOHD SOHAIL	P	P	P	P	P	P	P	P	P	P
56	14E31A0391	N VINESH REDDY	P	P	P	P	P	P	P	P	P	P
57	14E31A0392	NANDIGAM SURENDRA	P	P	P	P	P	P	P	P	P	P
58	14E31A0393	PITLA SWAMY	P	P	P	P	P	P	P	P	P	P
59	14E31A0396	RINJU GEORGE	P	P	P	P	P	P	P	P	P	P
60	14E31A03A0	VADLURI KRISHNA	P	P	P	P	P	P	P	P	P	P
61	14E31A03A1	YERRA ARVIND REDDY	P	P	P	P	P	P	P	P	P	P
62	14E31A03A2	SHEOB AHMED	P	P	P	P	P	P	P	P	P	P
63	14E31A03A3	SYED MD AHMED MOHUDDIN QUADRI	P	P	P	P	P	P	P	P	P	P
64	13E31A0380	MOHD FARHAN UDDIN	P	P	P	P	P	P	P	P	P	P
65	15E35A0302	H AKHILESH	P	P	P	P	P	P	P	P	P	P
66	15E35A0303	HEEREKAR RAHUL	P	P	P	P	P	P	P	P	P	P

PRINCIPAL
 MAHAVEER
 ENGINEERING COLLEGE
 VYSAMPATI, HYDRABAD

Vysapuri, Bandlaguda Post, Kothavaram,
Hyderabad-500 005, Telangana, INDIA
Tel: 040-64596979, 20020773, Fax: 040-24455003
E-mail: principal.mahaveer@gmail.com
Website: www.mist.ac.in

MAHAVEER



Approved by AICTE, Affiliated to JNTUH, Hyd

DEPARTMENT OF MECHANICAL ENGINEERING

List of students enrolled in ANSYS (2017-2018)

67	15E35A0304	MAMIDIGA NAGESH	P	P	P	P	P	P	P	P	P	P
68	15E35A0305	MD SHOEB AKRAM	P	P	P	P	P	P	P	P	P	P
69	15E35A0307	MYAKALA SHIVAKUMAR	P	P	P	P	P	P	P	P	P	P
70	15E35A0308	SYED ASHFAQ	P	P	P	P	P	P	P	P	P	P
71	13E31A0318	C VENKATESH	P	P	P	P	P	P	P	P	P	P

Kishor
PRINCIPAL
MAHAVEER
INSTITUTE OF SCIENCE AND TECHNOLOGY
HYD-500 005

Vysapuri, Bandlaguda Post:Keshavgiri,

Hyderabad-500 005, TELANGANA INDIA
Tel: 040-64596979,8978380692,Fax: 040-24455003
E-mail: o3hod.it@gmail.com,
Website: www.mist.ac.in,

MAHAVEER

INSTITUTE OF SCIENCE & TECHNOLOGY

Approved by AICTE, Affiliated to JNTUH,Hyd.



DEPARTMENT OF ELECTRONICS AND COMMUNICATION ENGINEERING

Date: 04-09-2017

CIRCULAR

Technical Trainings on C programming is starting from 22-09-2017 onwards. All the students II year ,B.Tech I Semester should attend.

Design and development of curriculum for add-on courses :

Faculty Names: 1.Dr. Jaspal Kumar

2.Mr.R. Prabhakar

3. Mr. D. Laxmi Narayana

HOD, ECE

Cc: Principal for information

: Coordinator to inform the students

: Notice board & department File.

PRINCIPAL
MAHAVEER
INSTITUTE OF SCIENCE & TECHNOLOGY
Bandlaguda, Hyd-500 005.

Vysapuri, Bandlaguda Post:Keshavgiri,

MAHAVEER

INSTITUTE OF SCIENCE & TECHNOLOGY

Approved by AICTE, Affiliated to JNTUH,Hyd.



Hyderabad-500 005, TELANGANA INDIA

Tel: 040-64596979,8978380692,Fax: 040-24455003

E-mail: a3hod.it@gmail.com,

Website: www.mist.ac.in,

DEPARTMENT OF ELECTRONICS AND COMMUNICATION ENGINEERING

SYLLABUS FOR Training - C programming

SNO	TOPIC COVERED	DURATION
1	Introduction to Principles of programming	3
2	Introduction to C Programming	3
3	Operators and Expressions	3
4	Data Types and Input/Output Operators	3
5	Control Statements and Decision Making	3
6	Arrays and Strings	3
7	Pointers	3
8	Structures and Unions	3
9	Functions	3
10	Storage Classes	3
11	The Preprocessor	3
12	Dynamic Memory Allocation	3
13	File Management	3

HOD-ECE

PRINCIPAL
MAHAVEER
INSTITUTE OF SCIENCE & TECHNOLOGY
Bandlaguda, Hyd-500 005.

Vysapuri, Bandlaguda Post:Keshavgi,ri,

MAHAVEER

INSTITUTE OF SCIENCE & TECHNOLOGY

Approved by AICTE, Affiliated to JNTUH,Hyd



Hyderabad-500 005, TELANGANA INDIA
Tel: 040-64596979,8978380692,Fax: 040-24455003
E-mail: e3hod.it@gmail.com
Website: www.mist.ac.in,

DEPARTMENT OF ELECTRONICS AND COMMUNICATION ENGINEERING

LIST OF REGISTERED STUDENTS FOR Training - C programming

S.NO	H.T. NO.	NAME OF STUDENT
1	16E31A0401	ADARSHNA AKSHAYA
2	16E31A0402	ATNUGULA SWATHE
3	16E31A0403	ANAGOINI SHIVANI GOUD
4	16E31A0405	ASHALA GANESH
5	16E31A0406	AVVARI BHARGAVI
6	16E31A0407	B NAVYA SRI
7	16E31A0408	BADAMSAI SHANKER
8	16E31A0410	HYREDDY SRIDEVI
9	16E31A0413	DESHAM PREETHIKA
10	16E31A0415	DHARAVATHI THARUN
11	16E31A0416	ENJAMURI PAVAN SAI PREETAM
12	16E31A0418	G HARISH
13	16E31A0420	HASBI SHRUTHI
14	16E31A0421	JAGIDI VAMSHIKRISHNA
15	16E31A0422	KAKUSTAMPAVANI
16	16E31A0423	KALWA HARIKA
17	16E31A0426	KONAPARTHY ANJA CHARY
18	16E31A0427	KOTTALA VIKRAM
19	16E31A0428	KOYADA SWARNALATHA
20	16E31A0429	KUTKARNI MANOJ
21	16E31A0430	LAGISHETTY ADITHYA
22	16E31A0433	MOHAMMAD AMEER KHAN
23	16E31A0435	PAKEER GANESH
24	16E31A0436	PANYALA NAVYASREE
25	16E31A0437	PARIDULA SHIVA TEJA
26	16E31A0438	PETA SAI TEJA
27	16E31A0439	POKURI SHEKAR
28	16E31A0440	PRAVALIKA GADDAM
29	16E31A0442	RAPELLI HARIKA
30	16E31A0443	SHAIK RASHEEDA BEGUM

K. S. S.

PRINCIPAL
MAHAVEER
INSTITUTE OF SCIENCE & TECHNOLOGY
Bandlaguda, Hyd-500 005

Vysapuri, Bandlaguda Post: Keshavgiri,

Hyderabad-500 005, TELANGANA INDIA
Tel: 040-64596979,8978380692 Fax: 040-24455003
E-mail: e3hod.it@gmail.com,
Website: www.mist.ac.in,

MAHAVEER

INSTITUTE OF SCIENCE & TECHNOLOGY

Approved by AICTE, Affiliated to JNTUH,Hyd.



DEPARTMENT OF ELECTRONICS AND COMMUNICATION ENGINEERING

31	16E31A0456	ABHILASH REDDY KODIGANTI	17	23
32	16E31A0457	AERUKALA SAI CHITRA	18	22
33	16E31A0459	ANANTHOU SHIVANI	18	25
34	16E31A0460	ANKAM SRIVARSHA	20	28
35	16E31A0461	ANNABOINA SHALINI	17	23
36	16E31A0462	ANNAM SRAVAN	20	29
37	16E31A0463	ANUGONDA KIRAN KUMAR REDDY	18	23
38	16E31A0464	ANUMOLU NARENDRA SAI	20	20
39	16E31A0465	B PRADEEP	19	27
40	16E31A0466	BATTA SREE AMRUTH VAMSHI	17	24
41	16E31A0467	BIJJALA SHRAVANI	18	21
42	16E31A0468	BODOUPALLI VAMSHIKRISHNA	20	25
43	16E31A0469	CH SUSHMITHA	20	25
43	16E31A0470	CHALLA VARUN REDDY	20	20
44	16E31A0471	CHEKKALA GANESH	20	21
45	16E31A0472	CHILUKA HARISH	18	18
46	16E31A0474	CHITTEPU PREMALATHA	19	22
47	16E31A0475	CHOLLETI KAVYA	20	23
48	16E31A0476	ELAGANDHALA VAMSHI PRANAY	18	22
49	16E31A0477	ELLENDULA VARSHITH	20	25
50	16E31A0479	GANGIREDDY MAHENDER	18	26

Kanthy

PRINCIPAL
MAHAVEER
INSTITUTE OF SCIENCE & TECHNOLOGY
Bandlaguda, Hyd-500 005.

Vysapuri, Bandlaguda Post:Keshavgiri,

Hyderabad-500 005, TELANGANA INDIA
Tel: 040-64596979,8978380692,Fax: 040-24455003
E-mail: e3hod.it@gmail.com,
Website: www.mist.ac.in,

MAHAVEER

INSTITUTE OF SCIENCE & TECHNOLOGY

Approved by AICTE, Affiliated to JNTUH,Hyd



DEPARTMENT OF ELECTRONICS AND COMMUNICATION ENGINEERING

Training - C programming QUESTION PAPER

Duration: 120 Minutes

10 X 3 = 30 Marks

Answer the following all questions. Each question carries 2 marks.

1. Distinguish between malloc() & calloc() memory allocation.
2. Explain the syntax for for loop.
3. What is recursion?
4. What is typecasting?
5. What are command line arguments?
6. What is a preprocessor?
7. What is a self-referential structure?
8. What is the difference between actual and formal parameters?
9. What is the purpose of the keyword typedef?
10. What are storage classes?

HOD-ECE



PRINCIPAL
MAHAVEER
INSTITUTE OF SCIENCE & TECHNOLOGY
Bandlaguda, Hyd-500 005.

Vysapuri, Bandlaguda Post:Keshavgi,

MAHAVEER

INSTITUTE OF SCIENCE & TECHNOLOGY

Approved by AICTE, Affiliated to JNTUH,Hyd.



Hyderabad-500 005, TELANGANA INDIA

Tel: 040-64596979,8978380692, Fax: 040-24455003

E-mail: a3hod.it@gmail.com,

Website: www.mist.ac.in,

DEPARTMENT OF ELECTRONICS AND COMMUNICATION ENGINEERING

STUDENTS ATTENDANCE AND RESULT SHEET FOR Training - C programming

S.NO	H.T. NO.	NAME OF STUDENT	ATTENDACE 20)HRS	MARKS OBTAINED(30)
1	16E31A0401	ADARSHINA AKSHAYA	17	27
2	16E31A0402	AENUGULA SWATHI	18	24
3	16E31A0403	ANAGOUNI SHEVANI GOUD	18	14
4	16E31A0405	ASHALA GANESH	20	25
5	16E31A0406	AYYARI BHARGAVI	17	25
6	16E31A0407	B NAVYA SRI	20	15
7	16E31A0408	BADAM SAI SHANKER	17	14
8	16E31A0410	HYREDDY SRIDEVI	20	22
9	16E31A0413	DESHAM PREETHIKA	20	28
10	16E31A0415	DEARAYATH THARUN	20	ABSENT
11	16E31A0416	ENJAMURI PAVAN SAI PREETAM	17	26
12	16E31A0418	G HARISH	18	12
13	16E31A0420	HASBI SHRUTHI	18	22
14	16E31A0421	JAGDI VAMSHIKRISHNA	20	23
15	16E31A0422	KAKUSTAM PAVANI	17	22
16	16E31A0423	KALWA HARIKA	20	25
17	16E31A0426	KONAPARTHY ANEA CHARY	18	28
18	16E31A0427	KOTTALA VIKRAM	20	23
19	16E31A0428	KOYADA SWARNALATHA	19	29
20	16E31A0429	KULKARNI MANOJ	17	23
21	16E31A0430	LAGISHETTY ADITHYA	18	20
22	16E31A0433	MOHAMMAD AMEER KHAN	20	27
23	16E31A0435	PAKEER GANESH	20	24
24	16E31A0436	PANYALA NAVYASREE	20	21
25	16E31A0437	PARIDULA SHIVA TEJA	20	25
26	16E31A0438	PETA SAI TEJA	18	25
27	16E31A0439	POKURI SHEKAR	19	20
28	16E31A0440	PRAVALIKA GADDAM	20	21
29	16E31A0442	RAPELLI HARIKA	18	23
30	16E31A0443	SHAIK RASHEEDA BEGUM	20	22

Kshy
PRINCIPAL
MAHAVEER
INSTITUTE OF SCIENCE & TECHNOLOGY
Bandlaguda, Hyd-500 005

Vysapuri, Bandlaguda Post:Keshavgiri,

Hyderabad-500 005, TELANGANA INDIA
Tel: 040-64596979,8978380692.Fax: 040-24455003
E-mail: e3hod.it@gmail.com,
Website: www.mist.ac.in,

MAHAVEER

INSTITUTE OF SCIENCE & TECHNOLOGY

Approved by AICTE, Affiliated to JNTUH,Hyd.



DEPARTMENT OF ELECTRONICS AND COMMUNICATION ENGINEERING

31	16E31A0456	ABHILASH REDDY KOOIGANTI	17	23
32	16E31A0457	AERUKALA SAI CHITRA	18	22
33	16E31A0459	ANANTHOJU SHIVANI	18	25
34	18E31A0460	ANKAM SRIVARSHA	20	28
35	18E31A0461	ANNABOINA SHALINI	17	23
36	18E31A0462	ANNAM SRAVAN	20	28
37	18E31A0463	ANUGONDA KIRAN KUMAR REDDY	18	23
38	16E31A0464	ANUMOLU NARENDRA SAI	20	20
39	16E31A0465	B PRADEEP	19	27
40	18E31A0466	BATTA SREE AMRUTH VAMSHI	17	24
41	16E31A0467	BIJJALA SHRAVANI	18	21
42	16E31A0468	BOODUPALLI VAMSHIKRISHNA	20	25
43	16E31A0469	CH SUSHMITHA	20	25
43	16E31A0470	CHALLA VARUN REDDY	20	20
44	18E31A0471	CHEKKALA GANESH	20	21
45	16E31A0472	CHILUKA HARISH	18	23
46	16E31A0474	CHITTEPU PREMALATHA	18	22
47	18E31A0475	CHOLLETI KAVYA	20	23
48	16E31A0476	ELAGANDHALA VAMSHI PRANAY	18	22
49	16E31A0477	ELLENDULA VARSHITH	20	25
50	18E31A0479	GANGIREDDY MAHENDER	18	28

Kanthy
PRINCIPAL
MAHAVEER
INSTITUTE OF SCIENCE & TECHNOLOGY
bandlaguda, Hyd-500 005-

Vysapuri, Bandlaguda Post:Keshavgiri,

Hyderabad-500 005, TELANGANA INDIA
Tel: 040-64596979,8978380692.Fax: 040-24455003
E-mail: e3hod.it@gmail.com,
Website: www.mist.ac.in,

MAHAVEER

INSTITUTE OF SCIENCE & TECHNOLOGY

Approved by AICTE, Affiliated to JNTUH,Hyd.



DEPARTMENT OF ELECTRONICS AND COMMUNICATION ENGINEERING

SUMMARY REPORT OF Training - C programming

C is robust **language** and has rich set of built-in functions, data types and operators which can be used to write any complex **program**.

Program written in C are efficient due to availability of several data types and operators.

C is good choice for system-level programming. Nevertheless, it is not perfect for all programmers and all situations.

C pointers are a common source of confusion and programming errors.

C also lacks explicit support for useful abstractions such as classes and objects.

That may be a reason C is not preferable language for application-level programming. Newer languages such as C++ and Java address these issues for application-level programs.

C programming language is not limited to but used widely in operating systems, language compilers, network drivers, language interpreters, and system utilities areas of development.

COORDINATOR

Copy to:

1. Department Notice Board
2. Principal for Information
3. Committee Members (Academic)

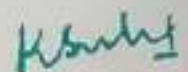

PRINCIPAL
MAHAVEER
INSTITUTE OF SCIENCE & TECHNOLOGY
Bandlaguda, Hyd-500 005.

Attendance sheet for Training - C programming registered students:

S.no	Hall Ticket No	Name of the Candidate	1	2	3	4	5	6	7	8	9	10	11	12	13	14	15	16	17	18	19	20	ATTENDANCE NCE(20hrs)	
1	16E31A0401	ADABODNA AKSHAYA	1	2	3	4	A	5	A	6	7	8	A	9	10	11	12	13	14	15	16	17	18	
2	16E31A0402	AENUGULA SWATHI	1	2	3	4	5	A	6	7	8	A	9	10	11	12	13	14	15	16	17	18	19	
3	16E31A0403	ANAGOUNI SHIVANI GOUD	1	2	3	4	5	6	7	8	9	10	11	12	A	13	A	14	15	16	17	18	19	20
4	16E31A0405	ASHALA GANESH	1	2	3	4	5	6	7	8	9	10	11	12	13	14	15	16	17	18	19	20	20	
5	16E31A0406	AVVARI BHARGAVI	1	2	3	4	5	6	7	8	A	9	10	11	12	A	13	14	15	A	16	17	18	19
6	16E31A0407	B NAVYA SRI	1	2	3	4	5	6	7	8	9	10	11	12	13	14	15	16	17	18	19	20	20	
7	16E31A0401	BADAM SAI SHANKER	1	2	3	4	5	6	7	8	9	10	11	A	12	13	A	14	15	16	A	17	18	19
8	16E31A0419	BYREDDY SRIDEVI	1	2	3	4	5	6	7	8	9	10	11	12	13	14	15	16	17	18	19	20	20	
9	16E31A0413	DESHAM PREEITHIKA	1	2	3	4	5	6	7	8	9	10	11	12	13	14	15	16	17	18	19	20	20	
10	16E31A0415	DHARAVATH THARUN	1	2	3	4	5	6	7	8	9	10	11	12	13	14	15	16	17	18	19	20	20	
11	16E31A0415	PREETAM	1	2	3	4	5	6	7	8	A	9	10	11	12	13	14	15	A	16	A	17	18	19
12	16E31A0418	G HARISH	1	2	3	4	5	6	7	8	9	10	A	11	A	12	13	14	15	16	17	18	19	20
13	16E31A0420	HASBI SHRUTHI	1	2	3	4	5	6	7	8	9	10	11	12	13	14	A	A	15	16	17	18	19	20
14	16E31A0421	JAGHI VAMSHIKRISHNA	1	2	3	4	5	6	7	8	9	10	11	12	13	14	15	16	17	18	19	20	20	
15	16E31A0422	KAKUSTAM PAVANI	1	2	3	4	5	6	7	8	9	A	10	11	12	A	13	14	15	16	A	17	18	19
16	16E31A0423	KALWA HARIKA	1	2	3	4	5	6	7	8	9	10	11	12	13	14	15	16	17	18	19	20	20	
17	16E31A0426	KONAPARTHY ANJA CHARY	1	2	3	4	5	6	7	8	9	10	11	12	13	14	15	16	A	17	18	A	19	20
18	16E31A0427	KOTTALA VIKRAM	1	2	3	4	5	6	7	8	9	10	11	12	13	14	15	16	17	18	19	20	20	
19	16E31A0428	KOYADA SWARNALATHA	1	2	3	4	5	6	7	8	9	10	11	A	12	13	14	15	16	17	18	19	20	
20	16E31A0429	KULKARNI MANOJ	1	2	3	4	5	6	7	8	A	9	10	11	A	12	13	A	14	15	16	17	18	19
21	16E31A0430	LAGISHETTY ADITHYA	1	2	3	4	5	6	7	A	8	9	10	11	12	13	14	15	16	A	17	18	19	20
22	16E31A0433	MOHAMMAD AMEER KHAN	1	2	3	4	5	6	7	8	9	10	11	12	13	14	15	16	17	18	19	20	20	
23	16E31A0435	PAKEER GANESH	1	2	3	4	5	6	7	8	9	10	11	12	13	14	15	16	17	18	19	20	20	
24	16E31A0436	PANYALA NAVYASREE	1	2	3	4	5	6	7	8	9	10	11	12	13	14	15	16	17	18	19	20	20	
25	16E31A0437	PARIDULA SHIVA TEJA	1	2	3	4	5	6	7	8	9	10	11	12	13	14	15	16	17	18	19	20	20	
26	16E31A0438	PETA SAITEJA	1	2	3	4	5	6	7	8	9	10	11	12	13	A	14	15	16	17	A	18	19	20
27	16E31A0439	POKURI SHEKAR	1	2	3	4	5	6	7	8	9	10	11	12	13	14	15	A	16	17	18	19	20	
28	16E31A0440	PRAVALIKA GADDAM	1	2	3	4	5	6	7	8	9	10	11	12	13	14	15	16	17	18	19	20	20	
29	16E31A0442	RAPELLI HARIKA	1	2	3	4	5	6	7	8	A	9	10	11	12	13	14	15	16	A	17	18	19	20
30	16E31A0443	SHAIK RASHEEDA BEGUM	1	2	3	4	5	6	7	8	9	10	11	12	13	14	15	16	17	18	19	20	20	

MAHAVEER
INSTITUTE OF SCIENCE & TECHNOLOGY
Bandlaguda, Hyd-500 088

31	18E31A0456	ASHILASH REDDY KODIGANTI	1	2	3	4	5	6	7	8	A	9	10	11	12	A	13	14	15	A	16	17	18
32	18E31A0457	AERUKALA SAI CHITRA	1	2	3	4	5	6	7	8	9	10	11	12	13	14	15	16	A	17	18	A	19
33	18E31A0458	ANANTHOJU SHIVANI	1	2	3	4	5	6	7	8	9	10	11	12	13	14	A	15	16	A	17	B	18
34	18E31A0459	ANKAM SRIVARSHA	1	2	3	4	5	6	7	8	9	10	11	12	13	14	15	16	17	18	19	20	21
35	18E31A0461	ANNABONA SHALINI	1	2	3	4	5	6	7	8	9	10	A	11	A	12	A	13	14	15	16	17	18
36	18E31A0462	ANNAM SRIVAN	1	2	3	4	5	6	7	8	9	10	11	12	13	14	15	16	17	18	19	20	21
37	18E31A0463	REDDY	1	2	3	4	5	6	7	8	9	10	11	12	A	13	14	15	16	17	A	18	19
38	18E31A0464	ANUMOLU NARENORA SAI	1	2	3	4	5	6	7	8	9	10	11	12	13	14	15	16	17	18	19	20	21
39	18E31A0465	S PRADEEP	1	2	3	4	5	6	7	8	9	10	11	12	13	14	15	16	A	17	18	19	20
40	18E31A0466	BATTA SREE AMRUTH VAMSHI	1	2	3	4	5	6	7	8	9	10	A	11	12	A	13	14	15	16	A	17	18
41	18E31A0467	BIJALA SHRAVAN	1	2	3	4	5	6	7	8	9	10	11	12	13	14	A	15	16	A	17	18	19
42	18E31A0468	BODUPALLI VAMSHIKRISHNA	1	2	3	4	5	6	7	8	9	10	11	12	13	14	15	16	17	18	19	20	21
43	18E31A0469	CH SUSHMITHA	1	2	3	4	5	6	7	8	9	10	11	12	13	14	15	16	17	18	19	20	21
44	18E31A0470	CHALLA VARUN REDDY	1	2	3	4	5	6	7	8	9	10	11	12	13	14	15	16	17	18	19	20	21
45	18E31A0471	CHEKALA GANESH	1	2	3	4	5	6	7	8	9	10	11	12	13	14	15	16	17	18	19	20	21
46	18E31A0472	CHILUKA HARISH	1	2	3	4	5	6	7	8	9	10	11	12	13	14	15	16	A	17	18	A	19
47	18E31A0474	CHITTEPU PREMALATHA	1	2	3	4	5	6	7	8	9	10	11	12	13	A	14	15	16	17	18	19	20
48	18E31A0475	CHOLLETI KAVYA	1	2	3	4	5	6	7	8	9	10	11	12	13	14	15	16	17	18	19	20	21
49	18E31A0476	PRANAY	1	2	3	4	5	6	7	8	9	10	11	12	13	A	14	15	A	16	17	18	19
50	18E31A0477	ELLENOLA VARSHITH	1	2	3	4	5	6	7	8	9	10	11	12	13	14	15	16	17	18	19	20	21
51	18E31A0479	GANGIREDDY MAHENDER	1	2	3	4	5	6	7	8	9	10	11	12	A	13	14	15	16	17	A	18	19

Co-ordinator

HOD, ECE Dept

PRINCIPAL
MAHAVEER
INSTITUTE OF SCIENCE & TECHNOLOGY
Bandlaguda, Hyd-500 005.

Vysapuri, Bandlaguda Post:Keshavgiri,

Hyderabad-500 005, TELANGANA INDIA
Tel: 040-64596979,8978380692 Fax: 040-24455003
E-mail: e3hod_it@gmail.com,
Website: www.mist.ac.in,

MAHAVEER

INSTITUTE OF SCIENCE & TECHNOLOGY

Approved by AICTE, Affiliated to JNTUH,Hyd.



DEPARTMENT OF ELECTRONICS AND COMMUNICATION ENGINEERING

Date: 01-02-2018

CIRCULAR

Technical Trainings on Java Certification programme is starting from 22-12-2018 onwards.

All the students II year ,B.Tech II Semester should attend.

Design and development of curriculum for add-on courses :

Faculty Names: 1.Dr. Jaspal Kumar
2.Dr. M. Sandhya Rani
3. Dr. V.G. Supriya

HOD, ECE

Cc: Principal for information
Coordinator to inform the students
Notice board & department File.



PRINCIPAL
MAHAVEER
INSTITUTE OF SCIENCE & TECHNOLOGY
Bandlaguda, Hyd-500 005.

Vysapuri, Bandlaguda Post:Keshavgiri,

Hyderabad-500 005, TELANGANA INDIA
Tel: 040-64596979,8978380692,Fax: 040-24456003
E-mail: e3hod.it@gmail.com,
Website: www.mist.ac.in,

MAHAVEER
INSTITUTE OF SCIENCE & TECHNOLOGY
Approved by AICTE, Affiliated to JNTUH,Hyd.



DEPARTMENT OF ELECTRONICS AND COMMUNICATION ENGINEERING

Date: 01-02-2018

SYLLABUS FOR Java Certification programme

SNO	TOPIC COVERED	DURATION
1	Introduction	3
2	OOPS (Object Oriented Programming & Systems)	3
3	STRING Manipulation	3
4	Array	3
5	Packages	3
6	Exception Handling	3
7	I/O Streams	3
8	Multithreading	3
9	Wrapper Classes	3
10	Inner Classes	3
11	Collection Frame Work	3
12	AWT	3
13	SWING (JFC)	3

HOD-ECE

PRINCIPAL
MAHAVEER
INSTITUTE OF SCIENCE & TECHNOLOGY
Bandlaguda, Hyd-500 005.

Vysapuri, Bandlaguda Post Keshavgi,

Hyderabad-500 005, TELANGANA INDIA
Tel: 040-64596979,8978380692, Fax: 040-24455003
E-mail: e3hod.it@gmail.com,
Website: www.mist.ac.in,

MAHAVEER

INSTITUTE OF SCIENCE & TECHNOLOGY

Approved by AICTE. Affiliated to JNTUH,Hyd.



DEPARTMENT OF ELECTRONICS AND COMMUNICATION ENGINEERING

LIST OF REGISTERED STUDENTS FOR Java Certification programme

S.NO	H.T. NO.	NAME OF STUDENT
1	16E31A0401	ADABOINA AKSHAYA
2	16E31A0402	AENUGULA SWATI
3	16E31A0403	ANAGOUNI SHIVANI GOUD
4	16E31A0405	ASHALA GANESH
5	16E31A0406	AVVARI BHARGAVI
6	16E31A0407	B NAVYA SRI
7	16E31A0408	BADAM SAI SHANKER
8	16E31A0410	BYREDDY SRIDEVI
9	16E31A0413	DESHAM PREETHIKA
10	16E31A0415	DHARAVATHI THARUN
11	16E31A0416	ENJAMURI PAVAN SAI PREETAM
12	16E31A0418	G HARISH
13	16E31A0420	HASBI SHRUTHI
14	16E31A0421	JAGIDI VAMSIKRISHNA
15	16E31A0422	KAKUSTAM PAVANI
16	16E31A0423	KALWA HARIKA
17	16E31A0426	KONAPARTHY ANJA CHARY
18	16E31A0427	KOTTALA VIKRAM
19	16E31A0428	KOYADA SWARNALATHA
20	16E31A0429	KULKARNI MANOJ
21	16E31A0430	LAGISHETTY ADITHYA
22	16E31A0433	MOHAMMAD AMEER KHAN
23	16E31A0435	PAKEER GANESH
24	16E31A0436	PANYALA NAVYASREE
25	16E31A0437	PARIDULA SHIVA TEJA
26	16E31A0438	PETA SAI TEJA
27	16E31A0439	POKURI SHEKAR
28	16E31A0440	PRAVALIKA GADDAM
29	16E31A0442	RAPELLI HARUKA
30	16E31A0443	SHAIK BASHEEDA BEGUM

Khanif
PRINCIPAL
MAHAVEER
INSTITUTE OF SCIENCE & TECHNOLOGY
Bandlaguda, Hyd-500 005

Vysapuri, Bandlaguda Post: Keshavgi,ri,

MAHAVEER

INSTITUTE OF SCIENCE & TECHNOLOGY

Approved by AICTE, Affiliated to JNTUH,Hyd.



Hyderabad-500 005, TELANGANA INDIA

Tel: 040-64596979,8978380692, Fax: 040-24455003

E-mail: e3hod.ite@gmail.com,

Website: www.mist.ac.in,

DEPARTMENT OF ELECTRONICS AND COMMUNICATION ENGINEERING

31	16E31A0456	ASHILASH REDDY KODIGANTI
32	16E31A0457	AERUKALA SAI CHITRA
33	16E31A0459	ANANTHOJU SHIVANI
34	16E31A0460	ANKAM SRIVARSHA
35	16E31A0461	ANNABONA SHALINI
36	16E31A0462	ANNAM SRAVAN
37	16E31A0463	ANUGONDA KIRAN KUMAR REDDY
38	16E31A0464	ANUMOLU NARENORA SAI
39	16E31A0465	B PRADEEP
40	16E31A0466	BATTA BREE AMRUTH VAMSHI
41	16E31A0467	BUJALA SHRAVANI
42	16E31A0468	BODDUPALLI VAMSHIKRISHNA
43	16E31A0469	CH SUSHMITHA
43	16E31A0470	CHALLA VARUN REDDY
44	16E31A0471	CHEKKALA GANESH
45	16E31A0472	CHILUKA HARISH
46	16E31A0474	CHITTEPU PREMALATHA
47	16E31A0475	CHOLLETI KAVYA
48	16E31A0476	ELAGANDHALA VAMSHI PRANAY
49	16E31A0477	ELLENDULA VARSHITH
50	16E31A0479	GANGIREDDY MAHENDER

K. S. S. S.

PRINCIPAL
MAHAVEER
INSTITUTE OF SCIENCE & TECHNOLOGY
Bandlaguda, Hyd-500 005.

Vysapuri, Bandlaguda Post:Keshavgiri,

Hyderabad-500 005, TELANGANA INDIA
Tel: 040-64596979,8978380692,Fax: 040-24465003
E-mail: e3hod.it@gmail.com,
Website: www.mist.ac.in,

MAHAVEER

INSTITUTE OF SCIENCE & TECHNOLOGY

Approved by AICTE, Affiliated to JNTUH,Hyd.



DEPARTMENT OF ELECTRONICS AND COMMUNICATION ENGINEERING

Java Certification programme QUESTION PAPER

Duration: 120 Minutes

10 X 3 = 30 Marks

Answer the following all questions. Each question carries 2 marks.

Q1. Explain JDK, JRE and JVM?

Q2. Explain public static void main(String

args[]) in Java

Q3. Why Java is platform independent?

Q4. Why Java is not 100% Object-oriented?
Q5. What are wrapper classes in Java?

Q6. What are constructors in Java?

Q7. What is singleton class in Java and how can we make a class singleton?
Q8. What is the difference between Array list and vector in Java?

Q9. What is the difference between equals() and == in Java?

Q10. What are the differences between Heap and Stack Memory in Java?

HOD-ECE

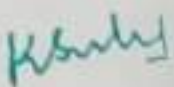

PRINCIPAL
MAHAVEER
INSTITUTE OF SCIENCE & TECHNOLOGY
Bandlaguda, Hyderabad-500 005

Vysapuri, Bandlaguda Post:Keshavgi,ri,

Hyderabad-500 005, TELANGANA INDIA
Tel: 040-64596979,8978380692,Fax: 040-24455003
E-mail: e3hod.it@gmail.com,
Website: www.mist.ac.in,

MAHAVEER
INSTITUTE OF SCIENCE & TECHNOLOGY
Approved by AICTE, Affiliated to JNTUH,Hyd.



DEPARTMENT OF ELECTRONICS AND COMMUNICATION ENGINEERING

STUDENTS ATTENDANCE AND RESULT Java Certification program me

S.NO	H.T. NO.	NAME OF STUDENT	ATTENDACE 20)HRS	MARKS OBTAINED(30)
1	16E31A0401	ADABOINA AKSHAYA	17	27
2	16E31A0402	AENUCULA SWATHE	18	24
3	16E31A0403	ANAGOONI SHIVANI GOUD	18	14
4	16E31A0405	ASHALA GANESH	20	25
5	16E31A0406	AVVARI BHARGAVI	17	25
6	16E31A0407	H NAVYA SRI	20	15
7	16E31A0408	BADAM SAI SHANKER	17	14
8	16E31A0410	BYREDDY SRIDEVI	20	22
9	16E31A0413	DESHAM PREETHIKA	20	28
10	16E31A0415	DHARAVATH THAREN ENJAMURI PAVAN SAI PREETAM	20	ABSENT
11	16E31A0416		17	26
12	16E31A0418	G HARISH	18	12
13	16E31A0420	HASBI SHRUTHI	18	22
14	16E31A0421	JAGIDI VAMSHIKRISHNA	20	23
15	16E31A0422	KAKUSTAM PAVANI	17	22
16	16E31A0423	KAIWA HARIEA	20	25
17	16E31A0426	KONAPARTHY ANJA CHARY	18	28
18	16E31A0427	KOTTALA VIKRAM	20	23
19	16E31A0428	KOYADA SWARNALATHA	19	29
20	16E31A0429	KULKARNI MANOJ	17	23
21	16E31A0430	LAGISHETTY ADITHYA	18	20
22	16E31A0433	MOHAMMAD AMEER KHAN	20	27
23	16E31A0435	PAKBER GANESH	20	24
24	16E31A0436	PANYALA NAVYASREE	20	21
25	16E31A0437	PARIDULA SHEVA TEJA	20	25
26	16E31A0438	PETA SAI TEJA	18	25
27	16E31A0439	POKURI SHEKAR	19	20
28	16E31A0440	PRAVALIKA GADDAM	20	21
29	16E31A0442	RAPELLI HARIKA	18	23
30	16E31A0443	SHAIK RASHERDA BEGUM	20	22

K. Srinivas

PRINCIPAL

MAHAVEER

INSTITUTE OF SCIENCE & TECHNOLOGY

Vysapuri, Bandlaguda Post:Keshavgiri,

MAHAVEER

INSTITUTE OF SCIENCE & TECHNOLOGY

Approved by AICTE, Affiliated to JNTUH,Hyd.



Hyderabad-500 005, TELANGANA INDIA

Tel: 040-64596979,8978380692,Fax: 040-24455003

E-mail: e3hod.it@gmail.com,

Website: www.mist.ac.in,

DEPARTMENT OF ELECTRONICS AND COMMUNICATION ENGINEERING

31	16E31A0456	ABHILASHREDDY KODIGANTI	17	23
32	16E31A0457	AERUKALA SAI CHITRA	18	22
33	16E31A0459	ANANTHOJU SHIVANI	18	25
34	16E31A0460	ANKAM SRIVARSHA	20	28
35	16E31A0461	ANNABOINA SHALINI	17	23
36	16E31A0462	ANNAM SRAVAN	20	29
37	16E31A0463	ANUGONDA KIRAN KUMAR REDDY	18	23
38	16E31A0464	ANUMOLU NARENDRA SAI	20	20
39	16E31A0465	B PRADEEP	19	27
40	16E31A0466	BATTA SREE AMRUTH VAMSHI	17	24
41	16E31A0467	BIJJALA SHRAVANI	18	21
42	16E31A0468	BODDUPALLI VAMSHIKRISHNA	20	25
43	16E31A0469	CH SUSHMITHA	20	25
43	16E31A0470	CHALLA VARUN REDDY	20	20
44	16E31A0471	CHEKKALA GANESH	20	21
45	16E31A0472	CHILUKA HARISH	18	23
46	16E31A0474	CHITTEPU PREMALATHA	19	22
47	16E31A0475	CHOLLETI KAVYA	20	23
48	16E31A0476	ELAGANDHALA VAMSHI PRANAY	18	22
49	16E31A0477	ELLENDULA VARSHITH	20	25
50	16E31A0479	GANGIREDDY MAHENDER	18	28

K. Sankar

PRINCIPAL
MAHAVEER
INSTITUTE OF SCIENCE & TECHNOLOGY
Bandlaguda, Hyd-500 005.

Vysapuri, Bandlaguda Post: Keshavgiri,

Hyderabad-500 005, TELANGANA INDIA
Tel: 040-64596979, 8978380692, Fax: 040-24455003
E-mail: e3hod.it@gmail.com,
Website: www.mist.ac.in,

MAHAVEER

INSTITUTE OF SCIENCE & TECHNOLOGY

Approved by AICTE, Affiliated to JNTUH, Hyd.



DEPARTMENT OF ELECTRONICS AND COMMUNICATION ENGINEERING

SUMMARY REPORT OF Java Certification Programme

Java is one of the most popular programming languages used to create Web applications and platforms. It was designed for flexibility, allowing developers to write code that would run on any machine, regardless of architecture or platform.

Java is designed to be concurrent, class-based and object-oriented, as well as a computing platform first released by Sun Microsystems in 1995. An enormous amount of applications and websites will not work unless you have Java installed, and more are created every day.

Java is advertised, and esteemed for its fast performance, security, and reliability.

COORDINATOR

Copy to:

1. Department Notice Board
2. Principal for Information
3. Committee Members (Academic)

PRINCIPAL
MAHAVEER
INSTITUTE OF SCIENCE & TECHNOLOGY
Bandlaguda, Hyd-500 005.

Attendance sheet for Java Certification programme registered students:

Sno	Hall Ticket No	Name of the Candidate	1	2	3	4	5	6	7	8	9	10	11	12	13	14	15	16	17	18	19	20	ATTENDANCE NCF(20hrs)
1	16E31A0401	ADIBOENA AKSHAYA	1	2	3	4	5	6	7	8	A	9	A	10	11	A	12	13	14	15	16	17	18
2	16E31A0402	AENUGULA SWATHI	1	2	3	4	5	6	7	8	9	A	10	11	12	13	14	A	15	16	17	18	19
3	16E31A0403	ANAGOUNI SHIVANI GOUD	1	2	3	4	5	6	7	A	8	9	10	11	A	12	13	14	15	16	17	18	19
4	16E31A0405	ASHALA GANESH	1	2	3	4	5	6	7	8	9	10	11	12	13	14	15	16	17	18	19	20	20
5	16E31A0406	AVVARI BHARGAVI	1	2	3	4	5	A	6	7	8	9	A	10	11	12	13	A	14	15	16	17	18
6	16E31A0407	B NAVYA SRI	1	2	3	4	5	6	7	8	9	10	11	12	13	14	15	16	17	18	19	20	20
7	16E31A0408	BADAM SAI SHANKER	1	2	3	4	5	6	7	8	9	A	10	11	12	A	13	14	15	A	16	17	18
8	16E31A0410	DYREDDY SRIDEVI	1	2	3	4	5	6	7	8	9	10	11	12	13	14	15	16	17	18	19	20	20
9	16E31A0413	DESHAM PREETHIKA	1	2	3	4	5	6	7	8	9	10	11	12	13	14	15	16	17	18	19	20	20
10	16E31A0415	DHARAVATHI DHARUN	1	2	3	4	5	6	7	8	9	10	11	12	13	14	15	16	17	18	19	20	20
11	16E31A0416	ENIAMURI PAVAN SAI PREETAM	1	2	3	4	5	6	7	A	8	9	10	A	11	12	13	A	14	15	16	17	18
12	16E31A0418	G HARISH	1	2	3	4	5	6	7	8	9	A	10	11	12	A	13	14	15	16	17	18	19
13	16E31A0420	RASBI SHRUTHI	1	2	3	4	5	6	7	8	A	9	10	11	A	12	13	14	15	16	17	18	19
14	16E31A0421	JAGIDI VAMSHIKRISHNA	1	2	3	4	5	6	7	8	9	10	11	12	13	14	15	16	17	18	19	20	20
15	16E31A0422	KAKUSTAM PAVANI	1	2	3	4	5	6	7	8	9	10	A	11	12	A	13	14	A	15	16	17	18
16	16E31A0423	KALWA HARIKA	1	2	3	4	5	6	7	8	9	10	11	12	13	14	15	16	17	18	19	20	20
17	16E31A0426	KONAPARTHY ANJA CHARY	1	2	3	4	A	5	6	7	8	9	10	11	A	12	13	14	15	16	A	18	19
18	16E31A0427	KOTTALA VIKRAM	1	2	3	4	5	6	7	8	9	10	11	12	13	14	15	16	17	18	19	20	20
19	16E31A0428	KOYADA SWARNALATHA	1	2	3	4	5	6	A	9	8	9	10	11	12	13	14	15	16	17	18	19	20
20	16E31A0429	KULKARNI MANOJ	1	2	3	4	5	6	7	8	9	A	10	11	12	13	A	14	15	16	A	18	19
21	16E31A0430	LAGISHETTY ADITHYA	1	2	3	4	5	6	7	8	9	10	A	11	12	13	14	A	15	16	17	18	19
22	16E31A0433	MOHAMMAD AMEER KHAN	1	2	3	4	5	6	7	8	9	10	11	12	13	14	15	16	17	18	19	20	20
23	16E31A0435	PAKEER GANESH	1	2	3	4	5	6	7	8	9	10	11	12	13	14	15	16	17	18	19	20	20
24	16E31A0436	PANYALA NAVYASREE	1	2	3	4	5	6	7	8	9	10	11	12	13	14	15	16	17	18	19	20	20
25	16E31A0437	PARITHULA SHIVA TEJA	1	2	3	4	5	6	7	8	9	10	11	12	13	14	15	16	17	18	19	20	20
26	16E31A0438	PETA SAI TEJA	1	2	3	4	5	6	7	8	9	10	11	A	12	13	14	15	A	16	17	18	19
27	16E31A0439	POKURI SHEKAR	1	2	3	4	5	6	7	8	9	10	11	12	13	14	15	16	17	18	A	19	20
28	16E31A0440	PRAVALIKA GADDAM	1	2	3	4	5	6	7	8	9	10	11	12	13	14	15	16	17	18	19	20	20
29	16E31A0442	RAPELLI HARIKA	1	2	3	4	5	6	7	8	9	10	11	12	A	13	14	15	16	A	17	18	19
30	16E31A0443	SHAIK KASHEEDA BEGUM	1	2	3	4	5	6	7	8	9	10	11	12	13	14	15	16	17	18	19	20	20

MAHAVEER
INSTITUTE OF SCIENCE & TECH... -07
Bansloguda, Hyd-500 008

31	16E31A0456	ABHILASH REDDY KODIGANTI	1	2	3	4	5	6	7	8	9	10	11	12	13	14	15	16	17	18
32	16E31A0457	AERUKALA SAI CHITRA	1	2	3	4	5	6	7	8	9	10	11	12	13	14	15	16	17	18
33	16E31A0458	ANANTHOJU SHIVANI	1	2	3	4	5	6	7	8	9	10	11	12	13	14	15	16	17	18
34	16E31A0460	ANKAM SRIVARSHA	1	2	3	4	5	6	7	8	9	10	11	12	13	14	15	16	17	18
35	16E31A0461	ANNABOINA SHALINI	1	2	3	4	5	6	7	8	9	10	11	12	13	14	15	16	17	18
36	16E31A0462	ANNAM SRAVAN	1	2	3	4	5	6	7	8	9	10	11	12	13	14	15	16	17	18
37	16E31A0463	REDDY	1	2	3	4	5	6	7	8	9	10	11	12	13	14	15	16	17	18
38	16E31A0464	ANUMOLU NARENDRA SAI	1	2	3	4	5	6	7	8	9	10	11	12	13	14	15	16	17	18
39	16E31A0465	B PRADEEP	1	2	3	4	5	6	7	8	9	10	11	12	13	14	15	16	17	18
40	16E31A0466	BATTA SREE AMRUTH VAMSHI	1	2	3	4	5	6	7	8	9	10	11	12	13	14	15	16	17	18
41	16E31A0467	BIJJALA SHRAYAM	1	2	3	4	5	6	7	8	9	10	11	12	13	14	15	16	17	18
42	16E31A0468	BODDUPALLI VAMSHKRISHNA	1	2	3	4	5	6	7	8	9	10	11	12	13	14	15	16	17	18
43	16E31A0469	CH SUSHMITHA	1	2	3	4	5	6	7	8	9	10	11	12	13	14	15	16	17	18
44	16E31A0470	CHALLA VARUN REDDY	1	2	3	4	5	6	7	8	9	10	11	12	13	14	15	16	17	18
45	16E31A0471	CHEKKALA GANESH	1	2	3	4	5	6	7	8	9	10	11	12	13	14	15	16	17	18
46	16E31A0472	CHILUKA HARISH	1	2	3	4	5	6	7	8	9	10	11	12	13	14	15	16	17	18
47	16E31A0474	CHITTEPU PREMALATHA	1	2	3	4	5	6	7	8	9	10	11	12	13	14	15	16	17	18
48	16E31A0475	CHOLLETI KAVYA	1	2	3	4	5	6	7	8	9	10	11	12	13	14	15	16	17	18
49	16E31A0476	ELAGANDHALA VAMSHI PRANAY	1	2	3	4	5	6	7	8	9	10	11	12	13	14	15	16	17	18
50	16E31A0477	ELLENDULA VARSHITH	1	2	3	4	5	6	7	8	9	10	11	12	13	14	15	16	17	18
51	16E31A0479	GANGIREDDY MAHENDER	1	2	3	4	5	6	7	8	9	10	11	12	13	14	15	16	17	18

Co-ordinator

PRINCIPAL
MAHAVEER
DEPARTMENT OF SCIENCE & TECHNOLOGY
Bapatlaguda, Hyd-500 005.

HOD, ECE Dept

Vysapuri, Bandlaguda Post:Keshavgiri,

Hyderabad-500 005, TELANGANA INDIA

Tel: 040-64596979,8978380692.Fax: 040-24455003

E-mail: e3hod.cse@gmail.com,

Website: www.mist.ac.in,

MAHAVEER

INSTITUTE OF SCIENCE & TECHNOLOGY

Approved by AICTE, Affiliated to JNTUH,Hyd.



DEPARTMENT OF COMPUTER SCIENCE AND ENGINEERING

Date: 01-12-2020

CIRCULAR

Technical Trainings for II & IV B. Tech students are starting from 29-012-2020 onwards. All HODs and placements coordinators have to manage the trainings and ensure 95% attendance all through the sessions.

All mentors need to send the compiled feedback report to HOD at e3hod.cse@gmail.com daily. Mentors are advised to take care of PNR (Students not participating in training).

Agenda: **Basic Web Designing**

HOD-CSE

PRINCIPAL
MAHAVEER
INSTITUTE OF SCIENCE & TECHNOLOGY
Bandlaguda, Hyd-500 005.

Vysapuri, Bandlaguda Post:Keshavgiri,

Hyderabad-500 005, TELANGANA INDIA

Tel: 040-64696979,8978380692.Fax: 040-24455003

E-mail: g3hod.cse@gmail.com.

Website: www.mist.ac.in.

MAHAVEER

INSTITUTE OF SCIENCE & TECHNOLOGY

Approved by AICTE, Affiliated to JNTUH,Hyd.



DEPARTMENT OF COMPUTER SCIENCE AND ENGINEERING

SYLLABUS FOR Basic Web Designing

SNO	TOPIC COVERED	DURATION
1	Multimedia and its Applications	3
2	Mathematical Structure for Computer Science	3
3	Web Technologies	3
4	CSS	3
5	JavaScript	3
6	Adobe Flash	3
7	Animation Techniques	3
8	Introduction to Web Designing	3
9	Basics of Web Designing	3
10	Computer Graphics	3
11	HTML	3
12	Bootstrap	2
13	Adobe Dreamweaver	2
14	Softwares for Graphic Designing	2

HOD-CSE

PRINCIPAL
MAHAVEER
INSTITUTE OF SCIENCE & TECHNOLOGY
Bandlaguda, Hyd-500 005.

Vysapuri, Bandlaguda Post:Keshavgiri,

Hyderabad-506 005, TELANGANA INDIA

Tel: 040-64596979,8978380692,Fax: 040-24455003

E-mail: e3hod.cse@gmail.com,

Website: www.mist.ac.in,

MAHAVEER

INSTITUTE OF SCIENCE & TECHNOLOGY

Approved by AICTE, Affiliated to JNTUH,Hyd.



DEPARTMENT OF COMPUTER SCIENCE AND ENGINEERING

LIST OF REGISTERED STUDENTS FOR Basic web designing

SNO	HALL TICKET NO	NAME OF THE STUDENT
1	17E31A0501	A SHIRISHA
2	17E31A0502	BANDARI VARUN KUMAR
3	17E31A0504	BOGEE SUPRIYA
4	17E31A0507	CHEEMALA MAHESH
5	17E31A0508	CHELLOJU ANUSHA
6	17E31A0509	CHENCHU HARISH
7	17E31A0510	D GANESH
8	17E31A0512	G.HARIKA
9	17E31A0514	GANECHARY SHREYA
10	17E31A0515	GEETHIKA C
11	17E31A0516	GURRAM MANI RUPAK
12	17E31A0517	HUSNA HIBA
13	17E31A0519	JANUMPALLY GAYATHRI REDDY
14	17E31A0520	KANKATI ARAVIND
15	17E31A0521	KASULA VISHAKA
16	17E31A0522	KONGARI CHANDANA
17	17E31A0523	KOPPULA ANUSHRI
18	17E31A0525	KURA AKHILESH
19	17E31A0526	L ANIKETH SINGH
20	17E31A0528	LONE HARISH

Ben

ORIGINAL
MAHAVEER

INSTITUTE OF SCIENCE & TECHNOLOGY
Vysapuri, Bandlaguda, Hyderabad

Vysapuri, Bandlaguda Post:Keshavgi,

MAHAVEER

INSTITUTE OF SCIENCE & TECHNOLOGY

Approved by AICTE, Affiliated to JNTUH,Hyd.



Hyderabad-500 005, TELANGANA INDIA

Tel: 040-64596979,8978380692,Fax: 040-24455003

E-mail: e3hod.cse@gmail.com,

Website: www.mist.ac.in,

DEPARTMENT OF COMPUTER SCIENCE AND ENGINEERING

21	17E31A0530	MADDI MAIBU
22	17E31A0532	MANDAPURAM VINITHA
23	17E31A0533	MD ISMAIL
24	17E31A0537	PEDDOLLA ANAND REDDY
25	17E31A0539	RAGULA REKHA
26	17E31A0581	P LOKESH
27	17E31A0582	PATEL SAHITHI
28	17E31A0583	PENDYALA SAIDEEPA
29	17E31A0584	RAPOLU KALYAANI
30	17E31A0585	RIKKULA BHAVANI
31	17E31A0586	SAMUDRALA SAITEJA
32	17E31A0587	SERUSANI VIDHYA
33	17E31A0588	SYED ABDUL RAFAH
34	17E31A0589	SYED AFRIDI
35	17E31A0590	SYED OZAIR
36	19E31A0501	KUSUMBHA HEMANTH
37	19E31A0502	A JHANAVI
38	19E31A0503	ADICHERLA DHRUVAN
39	19E31A0504	ALCHETI PRAPUL
40	19E31A0505	ANDE SAI KIRAN
41	19E31A0506	ANTHA REDDY YESHWANTH REDDY

PRINCIPAL
MAHAVEER

INSTITUTE OF SCIENCE & TECHNOLOGY
HYDRABAD, 17E31A050005

Vysapuri, Bandlaguda Post:Keshavgiri,

Hyderabad-500 005, TELANGANA INDIA

Tel: 040-64596979,8978380692.Fax: 040-24455003

E-mail: e3hod.cse@gmail.com,

Website: www.mist.ac.in,

MAHAVEER

INSTITUTE OF SCIENCE & TECHNOLOGY

Approved by AICTE, Affiliated to JNTUH,Hyd.



DEPARTMENT OF COMPUTER SCIENCE AND ENGINEERING

42	19E31A0507	BOMMENA PHANI CHANDAN
43	19E31A0508	BOOSLA MEGHANA
44	19E31A0509	C PRAKASH
45	19E31A0510	CHITYALA MANOJ KUMAR
46	19E31A0557	AMGOTHA TIRUPATI
47	19E31A0558	AMOHAMMED MUQTAR MOHIUDDIN
48	19E31A0559	ASANABADHA RANJITHKUMAR
49	19E31A0560	BADA ANUSH
50	19E31A0561	BURRA HARSHITHA YADAV
51	19E31A0562	CHITIKALA KARTHIK
52	19E31A0563	GALIPELLI HARSHINI
53	19E31A0564	GOLLA RAVEENA
54	19E31A0565	HASSA FATIMA
55	19E31A0566	JANGA ABHISHEK
56	19E31A0567	KALLURI JYOTHIRMAI
57	19E31A0568	KAMRAN ALI AHMED
58	19E31A0569	KEMIDI SHIREESHA
59	19E31A0570	KHAMMAMPATI SAMYUKTHA
60	19E31A0571	KUMMAM RAHUL
61	19E31A0572	MANEPALLI HARSHA YARDHAN
62	19E31A0573	MATHANGI VIKITHA

PRINCIPAL
MAHAVEER
INSTITUTE OF SCIENCE & TECHNOLOGY
Bandlaguda, Hyderabad

Vysapuri, Bandlaguda Post:Keshavgiri,

MAHAVEER

INSTITUTE OF SCIENCE & TECHNOLOGY

Approved by AICTE, Affiliated to JNTUH,Hyd.



Hyderabad-500 005, TELANGANA INDIA

Tel: 040-64596979,8978380692.Fax: 040-24455003

E-mail: e3hod.cse@gmail.com,

Website: www.mist.ac.in,

DEPARTMENT OF COMPUTER SCIENCE AND ENGINEERING

63	19E31A0574	MIRIYALA SOMESHWARI
64	19E31A0575	MUSUNURU KAMAL NADH
65	19E31A0576	N MOUNIKA
66	19E31A0587	VISHAL KAKANI
67	19E31A0588	KOPPULA SHIVANI

PRINCIPAL
MAHAVEER

INSTITUTE OF SCIENCE & TECHNOLOGY
Bandlaguda, Hyd-500 005.

Vysapuri, Bandlaguda Post:Keshavgi,

Hyderabad-500 005, TELANGANA INDIA

Tel: 040-64596979,8978380692,Fax: 040-24455003

E-mail: e3hod.cse@gmail.com,

Website: www.mist.ac.in,

MAHAVEER

INSTITUTE OF SCIENCE & TECHNOLOGY

Approved by AICTE, Affiliated to JNTUH,Hyd.



DEPARTMENT OF COMPUTER SCIENCE AND ENGINEERING

Basic Web Designing QUESTION PAPER

Duration: 120 Minutes

8 X 2.5 = 20 Marks

Answer the following all questions. Each question carries 2.5 marks.

- 1.What are the most commonly used languages and platforms for website design?
- 2.What is HTML?
- 3.What is the function of CSS in web design?
- 4.What is an external style sheet?
- 5.Differentiate between HTML elements and HTML tags?
- 6.What is Semantic HTML?
7. What could be the problem of the hyperlink or image is not displaying correctly?
8. Is HTML and CSS enough to create a website?

HOD-CSE



PRINCIPAL
M/MAVEER
INSTITUTE OF SCIENCE & TECHNOLOGY
Bandlaguda, Hyderabad

Vysapuri, Bandlaguda Post:Keshavgi,

MAHAVEER

INSTITUTE OF SCIENCE & TECHNOLOGY

Approved by AICTE, Affiliated to JNTUH,Hyd.



Hyderabad-500 005, TELANGANA INDIA

Tel: 040-64596979,8978380692.Fax: 040-24455003

E-mail: g3hod.cse@gmail.com.

Website: www.mist.ac.in.

DEPARTMENT OF COMPUTER SCIENCE AND ENGINEERING

RESULT SHEET FOR Basic Web designing REGISTERED STUDENTS

SNO	HALL TICKET NO	NAME OF THE STUDENT	MARKS (20)	RESULT
1	17E31A0501	A SHIRISHA	20	PASS
2	17E31A0502	BANDARI VARUN KUMAR	19	PASS
3	17E31A0504	BOGEE SUPRIYA	20	PASS
4	17E31A0507	CHEEMALA MAHESH	18	PASS
5	17E31A0508	CHELLOJU ANUSHA	20	PASS
6	17E31A0509	CHENCHU HARISH	20	PASS
7	17E31A0510	D GANESH	16	PASS
8	17E31A0512	G.HARIKA	20	PASS
9	17E31A0514	GANECHARY SHREYA	20	PASS
10	17E31A0515	GEETHIKA C	17	PASS
11	17E31A0516	GURRAM MANI RUPAK	20	PASS
12	17E31A0517	HUSNA HIBA	20	PASS
13	17E31A0519	JANUMPALLY GAYATHRI REDDY	16	PASS
14	17E31A0520	KANKATI ARAVIND	20	PASS
15	17E31A0521	KASULA VISHAKA	20	PASS
16	17E31A0522	KONGARI CHANDANA	18	PASS
17	17E31A0523	KOPPULA ANUSHRI	20	PASS
18	17E31A0525	KURA AKHILESH	19	PASS
19	17E31A0526	L ANIKETH SINGH	20	PASS

PRINCIPAL

MAHAVEER

INSTITUTE OF SCIENCE & TECHNOLOGY

Bandlaguda, Hyderabad, 500 005

Vysapuri, Bandlaguda Post:Keshavgiri,

Hyderabad-500 005, TELANGANA INDIA
Tel: 040-64596979,8978380692,Fax: 040-24455003
E-mail: e3hod.cse@gmail.com,
Website: www.mist.ac.in,

MAHAVEER

INSTITUTE OF SCIENCE & TECHNOLOGY

Approved by AICTE. Affiliated to JNTUH,Hyd.



DEPARTMENT OF COMPUTER SCIENCE AND ENGINEERING

20	17E31A0528	LONE HARISH	18	PASS
21	17E31A0530	MADDI MAIBU	20	PASS
22	17E31A0532	MANDAPURAM VINITHA	20	PASS
23	17E31A0533	MD ISMAIL	16	PASS
24	17E31A0537	PEDDOLLA ANAND REDDY	20	PASS
25	17E31A0539	RAGULA REKHA	20	PASS
26	17E31A0581	P LOKESH	20	PASS
27	17E31A0582	PATEL SAHITHI	18	PASS
28	17E31A0583	PENDYALA SAIDEEPA	20	PASS
29	17E31A0584	RAPOLU KALYAANI	19	PASS
30	17E31A0585	RIKKULA BHAVANI	20	PASS
31	17E31A0586	SAMUDRALA SAITEJA	18	PASS
32	17E31A0587	SERUSANI VIDHYA	20	PASS
33	17E31A0588	SYED ABDUL RAFEH	20	PASS
34	17E31A0589	SYED AFRIDI	16	PASS
35	17E31A0590	SYED OZAIR	20	PASS
36	19E31A0501	KUSUMBHA HEMANTH	20	PASS
37	19E31A0502	A JHANAVI	17	PASS
38	19E31A0503	ADICHERLA DHYUVAN	20	PASS
39	19E31A0504	ALCHETI PRAPUL	20	PASS
40	19E31A0505	ANDE SAI KIRAN	16	PASS

PRINCIPAL
MAHAVEER
INSTITUTE OF SCIENCE & TECHNOLOGY
Bandlaguda, Hy. 500 005

Vysapuri, Bandlaguda Post:Keshavgirl,

MAHAVEER

INSTITUTE OF SCIENCE & TECHNOLOGY

Approved by AICTE. Affiliated to JNTUH,Hyd.



Hyderabad-500 005, TELANGANA INDIA

Tel: 040-64596979,8978380692. Fax: 040-24455003

E-mail: e3hod.cse@gmail.com.

Website: www.mist.ac.in.

DEPARTMENT OF COMPUTER SCIENCE AND ENGINEERING

41	19E31A0506	ANTHA REDDY YESHWANTH REDDY	20	PASS
42	19E31A0507	BOMMENA PHANI CHANDAN	20	PASS
43	19E31A0508	BOOSLA MEGHANA	18	PASS
44	19E31A0509	C PRAKASH	20	PASS
45	19E31A0510	CHITYALA MANOJ KUMAR	19	PASS
46	19E31A0557	AMGOTHA TIRUPATI	20	PASS
47	19E31A0558	AMOHAMMED MUQTAR MOHIUDDIN	18	PASS
48	19E31A0559	ASANABADHA RANJITHKUMAR	20	PASS
49	19E31A0560	BADA ANUSH	20	PASS
50	19E31A0561	BURRA HARSHITHA YADAV	16	PASS
51	19E31A0562	CHITIKALA KARTHIK	20	PASS
52	19E31A0563	GALIPELLI HARSHINI	20	PASS
53	19E31A0564	GOLLA RAVEENA	20	PASS
54	19E31A0565	HASSA FATIMA	18	PASS
55	19E31A0566	JANGA ABHISHEK	19	PASS
56	19E31A0567	KALLURI JYOTHIRMAI	20	PASS
57	19E31A0568	KAMRAN ALI AHMED	18	PASS
58	19E31A0569	KEMIDI SHIREESHA	17	PASS
59	19E31A0570	KHAMMAMPATI SAMYUKTHA	16	PASS
60	19E31A0571	KUMMAM RAHUL	20	PASS

PRINCIPAL

MAHAVEER

INSTITUTE OF SCIENCE & TECHNOLOGY
Bandlaguda, Hyderabad-500005

Vysapuri, Bandlaguda Post:Keshavgiri,

MAHAVEER

INSTITUTE OF SCIENCE & TECHNOLOGY

Approved by AICTE, Affiliated to JNTUH,Hyd.



Hyderabad-500 005, TELANGANA INDIA

Tel: 040-64596979,8978380692,Fax: 040-24455003

E-mail: e3hod.cse@gmail.com

Website: www.mist.ac.in

DEPARTMENT OF COMPUTER SCIENCE AND ENGINEERING

61	19E31A0572	MANEPALLI HARSHA VARDHAN	20	PASS
62	19E31A0573	MATHANGI VIKITHA	20	PASS
63	19E31A0574	MIRIYALA SOMESHWARI	18	PASS
64	19E31A0575	MUSUNURU KAMAL NADH	19	PASS
65	19E31A0576	N MOUNIKA	20	PASS
66	19E31A0587	VISHAL KAKANI	18	PASS
67	19E31A0588	KOPPULA SHIVANI	17	PASS

No. of students Registered:67

No. of students Passed:67

No. of students failed:NIL

PRINCIPAL
MAHAVEER
INSTITUTE OF SCIENCE & TECHNOLOGY
Bandlaguda, Hyd-500 005

Vysapuri, Bandlaguda Post:Keshavgiri,

Hyderabad-500 005, TELANGANA INDIA

Tel: 040-64596979,8978380692.Fax: 040-24455003

E-mail: e3hod.cse@gmail.com.

Website: www.mist.ac.in.

MAHAVEER

INSTITUTE OF STUDIES IN TECHNOLOGY

Approved by AICTE, Affiliated to JNTUH,Hyd.



DEPARTMENT OF COMPUTER SCIENCE AND ENGINEERING

SUMMARY REPORT OF Basic Web Designing

- Layout. If you want to design and build websites, understanding good layout is key. We suggest keeping things minimal.
- Color. You have the colors of the rainbow and beyond available to you. ... The power of the color picker can be wielded.
- Typography. Webflow comes with a wide selection of fonts and the option to add more. Typography is two-dimensional.

COORDINATOR

Copy to:

1. Department Notice Board
2. Principal for Information
3. Committee Members (Academic)

PRINCIPAL
MAHAVEER
INSTITUTE OF STUDIES IN TECHNOLOGY
BANDLAGUDA, HYD.

Vysapuri, Bandlaguda Post:Keshavgiri,

Hyderabad-500 005, TELANGANA INDIA
Tel: 040-64596979,8978380692, Fax: 040-24455003
E-mail: e3hod.it@gmail.com,
Website: www.mist.ac.in,

MAHAVEER

INSTITUTE OF TRAINING & TECHNOLOGY

Approved by AICTE, Affiliated to JNTUH,Hyd.



DEPARTMENT OF INFORMATION TECHNOLOGY

Date:01/09-2017

To,

The principal,
MIST,
Hyderabad.

Sub: Proposal for Add-on Course-Reg.

Dear Sir,

We are going to conduct two weeks workshop on **Training - C programming**. We require your approval to go head for further proceeding and hope to get an opportunity to serve you the best.

With thanks and Regards.

Kanthy
MIST
MAHAVEER
INSTITUTE OF TRAINING & TECHNOLOGY
Bandlaguda, Hyderabad-500 005.

01/09/2017

Vysapuri, Bandlaguda Post:Keshavgi,

MAHAVEER

INSTITUTE OF MANAGEMENT TECHNOLOGY

Approved by AICTE, Affiliated to JNTUH,Hyd.



Hyderabad-500 005, TELANGANA INDIA

Tel: 040-64596979,8978380692 Fax: 040-24455003

E-mail: e3hod.it@gmail.com,

Website: www.mist.ac.in,

DEPARTMENT OF INFORMATION TECHNOLOGY

Date: 04-09-2017

CIRCULAR

Technical Trainings for III & IV B. Tech students are starting from **11-09-2017** onwards. All HODs and placements coordinators have to manage the trainings and ensure 95% attendance all through the sessions.

All mentors need to send the compiled feedback report to HOD at e3hod@gmail.com daily. Mentors are advised to take care of PNR (Students not participating in training).

Agenda: Training - C programming

Design and Development of Curriculum for Add on Course:

Name of the Faculty: 1.CH B NAGALAKSHMI
2.S.SRINIVAS
3.V NARESH KUMAR REDDY

Kanthy
Principal
MAHAVEER
INSTITUTE OF MANAGEMENT TECHNOLOGY
Bandlaguda Post, Hyderabad-500 005.

N. Key
HOD

Vysapuri, Bandlaguda Post: Keshavgi, Hyderabad-500 005, TELANGANA INDIA

MAHAVEER



Tel: 040-64596979, 8978380692, Fax: 040-24455003
E-mail: e3hod.it@gmail.com
Website: www.mist.ac.in,

Approved by AICTE, Affiliated to JNTUH, Hyd.

DEPARTMENT OF INFORMATION TECHNOLOGY

SYLLABUS FOR Training - C programming

SNO	TOPIC COVERED	DURATION
1	Introduction to Principles of programming	3
2	Introduction to C Programming	3
3	Operators and Expressions	3
4	Data Types and Input/Output Operators	3
5	Control Statements and Decision Making	3
6	Arrays and Strings	3
7	Pointers	3
8	Structures and Unions	3
9	Functions	3
10	Storage Classes	3
11	The Preprocessor	3
12	Dynamic Memory Allocation	3
13	File Management	3

Handwritten signature
MAHAVEER
DEPARTMENT OF INFORMATION TECHNOLOGY
Bandlaguda, Hyd-500 005.

Handwritten signature
10-11

Vijayapark, Bandlaguda Post, Keshavnagar,

MAHAVEER



Hyderabad-500 005, TELANGANA INDIA
Tel: 040-64596979, 8978380692 Fax: 040-24455003
E-mail: e3hod.it@gmail.com,
Website: www.mist.ac.in,

Approved by AICTE, Affiliated to JNTUH, Hyd

DEPARTMENT OF INFORMATION TECHNOLOGY

LIST OF REGISTERED STUDENTS FOR Training - C programming

SNO	HALL TICKET NO	NAME OF THE STUDENT
1	14E31A1202	AREKATLA DIVYA
2	14E31A1204	B SAI KIRAN REDDY
3	14E31A1205	BANDHYALA AKSHAY REDDY
4	14E31A1206	DEVARANENI SRAVANI
5	14E31A1208	GANGIDI ANUSHA
6	14E31A1209	GANTE SANTHOSH
7	14E31A1210	GUJA SAI AKHIL
8	14E31A1211	KAVLI LALANI
9	14E31A1212	KORASIKA SAI KIRAN
10	14E31A1214	KURNAMONI DILIP
11	14E31A1215	MAHENDER SINGH
12	14E31A1216	MAMIDIPALLY MOUNIKA
13	14E31A1218	NALIMELA VINAY REDDY
14	14E31A1220	NARAGONI SHIVA VENKATA SAI
15	14E31A1221	PRANATHI PADAKANTI
16	14E31A1222	RAMA RAKESH
17	14E31A1223	RAMIDI KAVYA REDDY
18	14E31A1224	SREERAMINENI SRUJANA
19	14E31A1225	THIPPARAPU SRIVANI
20	14E31A1227	VEERAMREDDY MANASA
21	15E31A1202	AMAN SINGH BADYAL
22	15E31A1203	ARUTLA RAJ GOPAL
23	15E31A1204	BALLA UPENDRA
24	15E31A1205	BALMOORI SAHITHI
25	15E31A1206	CHAITANYA NIKHIL KUMAR
26	15E31A1207	D KRISHNA SRI
27	15E31A1208	D LAXMI SAROJA
28	15E31A1209	DORAGARI NIKHITHA
29	15E31A1210	DUMALA VENU
30	15E31A1211	GANDHASIRI BIHARATHI KUMAR
31	15E31A1212	GUNNALA SIRISHA
32	15E31A1213	K RASHMITHA
33	15E31A1214	KALIGOTA VIGNESH REDDY
34	15E31A1215	KAPARTHI SRIVARDHAN
35	15E31A1216	KARKONI NILESH
36	15E31A1217	KATAM PRIYANKA
37	15E31A1218	KATHROJU ASHOK
38	15E31A1219	KOLANU GREESHMA REDDY
39	15E31A1220	KONIDENA SAI VARSHITHA
40	15E31A1221	KOTLA VISWASRI
41	15E31A1222	KURUKUNTLA HARISH SAGAR

Handwritten signature
Principal
Date: 12/12/2014
Bandlaguda, Hyderabad - 500 005

Vyasagiri, Bandlaguda Post, Keshavnagar,

MAHAVEER



Hyderabad-500 005, TELANGANA INDIA
Tel: 040-64596970,8978380692 Fax: 040-24455003
E-mail: e3hod.it@gmail.com,
Website: www.mist.ac.in.

Approved by AICTE, Affiliated to JNTUH,Hyd.

DEPARTMENT OF INFORMATION TECHNOLOGY

42	15E31A1223	KUSUMA SAI VAMSHI ADITYA
43	15E31A1224	M BHAGYA LAXMI
44	15E31A1225	MITTAKANTI ANUSHA
45	15E31A1228	PINGALI SINDHU
46	15E31A1229	POSHETTY MANISHA
47	15E31A1231	SRIPEDAMHIDUR SRINIVAS SWAMY
48	15E31A1232	TUNIKI SHIVAKUMAR
49	15E31A1233	VILASAGARAM DEVENDAR
50	15E31A1235	YETHONDA NARAIHARIKRISHNA
51	15E31A1213	K.AKSHAY REDDY

Handwritten signature
P
INSTITUTE
Bandlaguda, Hyderabad-500 005

Vijayapuri, Banafalguda Post, Keshavnagar,

MAHAVEER



Hyderabad-500 005, TELANGANA INDIA
Tel: 040-64506979, 8079380692, Fax: 040-24455003
E-mail: info@mist.ac.in
Website: www.mist.ac.in

Approved by AICTE, Affiliated to JNTUH, Hyd

DEPARTMENT OF INFORMATION TECHNOLOGY

Training - C programming QUESTION PAPER

Duration: 120 Minutes

10 X 2 = 20 Marks

Answer the following all questions. Each question carries 2 marks.

1. Distinguish between malloc() & calloc() memory allocation.
2. Explain the syntax for for loop.
3. What is recursion?
4. What is typecasting?
5. What are command line arguments?
6. What is a preprocessor?
7. What is a self-referential structure?
8. What is the difference between actual and formal parameters?
9. What is the purpose of the keyword typedef?
10. What are storage classes?

K. Sankar
PRINCIPAL
MAHAVEER
INSTITUTE OF SCIENCE & TECHNOLOGY
Banafalguda, Hyd-500 005.

Vijayapur, Bandlaguda Post:Kothavogiri,

MAHAVEER



Hyderabad-500 005, TELANGANA INDIA
Tel: 040-64596979,8978380692.Fax: 040-24455003
E-mail: eshor.it@gmail.com,
Website: www.mist.ac.in,

Approved by AICTE, Affiliated to JNTUH,Hyd.

DEPARTMENT OF INFORMATION TECHNOLOGY

RESULT SHEET FOR Training - C programming REGISTERED STUDENTS

SNO	HALL TICKET NO	NAME OF THE STUDENT	MARKS (20)	RESULT
1	14E31A1202	AREKATLA DIVYA	20	PASS
2	14E31A1204	B SAI KIRAN REDDY	19	PASS
3	14E31A1205	BANDHYALA AKSHAY REDDY	20	PASS
4	14E31A1206	DEVARANENI SRAVANI	18	PASS
5	14E31A1208	GANGIDI ANUSHA	20	PASS
6	14E31A1209	GANTE SANTHOSH	20	PASS
7	14E31A1210	GUJJA SAI AKHIL	16	PASS
8	14E31A1211	KAVETI LALANI	20	PASS
9	14E31A1212	KORASIKA SAI KIRAN	20	PASS
10	14E31A1214	KURNAMONI DILIP	17	PASS
11	14E31A1215	MAHENDER SINGH	20	PASS
12	14E31A1216	MAMIDIPALLY MOUNIKA	20	PASS
13	14E31A1218	NALIMELA VINAY REDDY	16	PASS
14	14E31A1220	NARAGONI SHIVA VENKATA SAI	20	PASS
15	14E31A1221	PRANAHI PADAKANTI	20	PASS
16	14E31A1222	RAMA RAKESH	18	PASS
17	14E31A1223	RAMIDI KAVYA REDDY	20	PASS
18	14E31A1224	SREERAMINENI SRUJANA	19	PASS
19	14E31A1225	THIPPARAPU SRIVANI	20	PASS
20	14E31A1227	VEERAMREDDY MANASA	18	PASS
21	15E31A1202	AMAN SINGH BADYAL	20	PASS
22	15E31A1203	ARUTLA RAJ GOPAL	19	PASS
23	15E31A1204	BALLA UPENDRA	20	PASS
24	15E31A1205	BALMOORI SAHITHI	18	PASS
25	15E31A1206	CHITLA NIKHIL KUMAR	20	PASS
26	15E31A1207	D KRISHNA SRI	20	PASS
27	15E31A1208	D LAXMI SAROJA	16	PASS
28	15E31A1209	DORAGARI NIKHITHA	20	PASS
29	15E31A1210	DUMALA VENU	20	PASS
30	15E31A1211	GANDHASIRI BHARATH KUMAR	17	PASS
31	15E31A1212	GUNNALA SIRISHA	20	PASS
32	15E31A1213	K RASHMITHA	20	PASS
33	15E31A1214	KALIGOTA VIGNESH REDDY	16	PASS
34	15E31A1215	KAPARTHI SRIVARDHAN	20	PASS
35	15E31A1216	KARKONI NILESH	20	PASS
36	15E31A1217	KATAM PRIYANKA	18	PASS
37	15E31A1218	KATHROJU ASHOK	20	PASS
38	15E31A1219	KOLANU GREESHMA REDDY	19	PASS
39	15E31A1220	KONIDENA SAI VARSHITHA	20	PASS
40	15E31A1221	KOTLA VISWASRI	18	PASS
41	15E31A1222	KURUKUNTLA HARISH SAGAR	20	PASS

MAHAVEER INSTITUTE OF TECHNOLOGY
HYDRABAD
Approved by AICTE, Affiliated to JNTUH,Hyd.
Bandlaguda Post-500 005

Handlaqada (Banhalaguda Post, Keshavnagar)

MAHAVEER



Hyderabad-500 005, TELANGANA INDIA

Tel: 040-84596970, 8978380692 Fax: 040-24455003

E-mail: ed@ted.itg@gmail.com

Website: www.mist.ac.in

Approved by AICTE, Affiliated to JNTU(Hyd)

DEPARTMENT OF INFORMATION TECHNOLOGY

25	18I31AI273	KUSUMASAI VAMSHI ADITYA	50	PASS
26	18I31AI274	MURUGAYATI ANMI	16	PASS
27	18I31AI275	MILITAKANTHANI SILA	20	PASS
28	18I31AI276	PINGALI SINDHU	20	PASS
29	18I31AI277	IVONNETTY MANISHA	20	PASS
30	18I31AI278	KRIPESAMRUDDH SRINIVAS SWAMY	18	PASS
31	18I31AI279	LUNGISITHA AKUMAR	19	PASS
32	18I31AI280	VILASAGARAM DEVI NDAR	18	PASS
33	18I31AI281	YETIBONDA SARATHARIKRISHNA	17	PASS
34	18I31AI282	K. AKSHAY REDDY	19	PASS

No. of students Registered: 51

No. of students Passed: 51

No. of students failed: NIL

Kanthy
PRINCIPAL
MAHAVEER
INSTITUTE OF SCIENCE & TECHNOLOGY
Handlaqada, Hyd-500 005.



DEPARTMENT OF INFORMATION TECHNOLOGY

SUMMARY REPORT OF Training - C programming

C is robust language and has rich set of built-in functions, data types and operators which can be used to write any complex program.

Program written in C are efficient due to availability of several data types and operators.

C is good choice for system-level programming. Nevertheless, it is not perfect for all programmers and all situations.

C pointers are a common source of confusion and programming errors.

C also lacks explicit support for useful abstractions such as classes and objects.

That may be a reason C is not preferable language for application-level programming.

Newer languages such as C++ and Java address these issues for application-level programs.

C programming language is not limited to but used widely in operating systems, language compilers, network drivers, language interpreters, and system utilities areas of development.

COORDINATOR

Copy to:

1. Department Notice Board
2. Principal for Information
3. Committee Members (Academic)

PRINCIPAL
MAHAVEER
INSTITUTE OF SCIENCE & TECHNOLOGY
Keshavnagar, Hyd-500 005



MAHAVEER INSTITUTE OF SCIENCE & TECHNOLOGY
DEPARTMENT OF INFORMATION TECHNOLOGY
C Programming ATTENDANCE SHEET

SNO	NO	NAME OF THE STUDENT	Date																											
			1	11	0	13	13	14	14	15	15	16	16	18	18	19	19	20	20	21	21	22	22	23	23	24	24	25	25	
1	14131A1202	ARUKAIA DIVYA	P	P	A	P	A	A	P	A	P	P	A	A	P	P	A	A	P	P	A	A	P	P	P	P	P	P	P	P
2	14131A1204	H SAJKRAN REDDY	P	P	A	P	A	A	P	A	P	P	A	A	P	P	A	A	P	P	A	A	P	P	P	P	P	P	P	P
3	14131A1205	GUNEELVA S. KRISHA V. J. DIVY	P	P	A	P	P	A	P	P	P	A	P	P	A	P	P	A	P	P	A	P	P	P	P	P	P	P	P	P
4	14131A1206	DEVARASI SIBRAVA S	P	A	P	P	P	P	A	P	P	P	P	P	A	P	P	P	P	P	A	P	P	P	P	P	P	P	P	P
5	14131A1208	GANGHAM ANUSHA	P	P	A	P	P	P	A	P	P	P	P	P	A	P	P	P	P	A	P	P	P	P	P	P	P	P	P	P
6	14131A1209	GANTI SANCHOSHI	P	P	P	A	P	P	P	A	P	P	P	P	P	P	P	P	P	P	A	P	P	P	P	P	P	P	P	P
7	14131A1210	GAJASAI ANITHI	P	P	P	P	A	P	P	P	P	P	P	P	P	P	P	P	P	A	P	P	P	P	P	P	P	P	P	P
8	14131A1211	KAVITHA ANI	P	P	P	P	A	P	P	P	P	P	P	P	P	P	P	P	P	A	P	P	P	P	P	P	P	P	P	P
9	14131A1212	KORASIKKA SAIADITHYAN	P	P	P	P	A	P	P	P	P	A	P	P	P	P	P	P	P	A	P	P	P	P	P	P	P	P	P	P
10	14131A1214	KURUNAMONI DEVI	P	P	A	P	P	A	P	P	A	P	P	A	P	P	A	P	P	A	P	P	A	P	P	A	P	P	A	P
11	14131A1215	MAHENDRAN SUSHI	A	P	P	P	P	A	P	P	P	P	P	P	A	P	P	P	P	A	P	P	P	P	P	P	P	P	P	P
12	14131A1216	STANIDIPALY MANI S	P	P	P	P	A	P	P	P	P	A	P	P	P	P	P	P	P	A	P	P	P	P	P	P	P	P	P	P
13	14131A1218	NALINI S S VYASU	P	P	P	P	A	P	P	P	P	A	P	P	P	P	P	P	P	A	P	P	P	P	P	P	P	P	P	P
14	14131A1220	NARAGUNO SHIVANI S	P	P	P	P	P	A	P	P	P	A	P	P	P	P	P	P	P	A	P	P	P	P	P	P	P	P	P	P
15	14131A1221	PRANATHI PADMAN	A	P	P	A	P	P	A	P	P	A	P	P	A	P	P	P	P	A	P	P	P	P	P	P	P	P	P	P
16	14131A1222	RUSMA RAKSHI	P	P	P	P	P	P	A	P	P	P	P	A	P	P	P	P	A	P	P	P	P	P	P	P	P	P	P	P
17	14131A1223	RAMHARJANVA REDDY	P	P	P	P	P	P	P	P	P	P	P	P	P	P	P	P	P	P	P	P	P	P	P	P	P	P	P	P
18	14131A1224	SRIFRANJINI SUSHI	P	A	P	P	P	A	P	P	P	P	P	P	A	P	P	P	P	A	P	P	P	P	P	P	P	P	P	P
19	14131A1225	HIPPABADU SRIVANI	P	A	P	P	P	A	P	P	P	P	P	A	P	P	P	P	P	A	P	P	P	P	P	P	P	P	P	P
20	14131A1227	VILRAMBIDU SIVANI	P	A	A	P	P	A	P	P	A	P	P	A	P	P	A	P	P	A	P	P	P	P	P	P	P	P	P	P
21	14131A1202	AMAN SINGH REDDY	P	P	P	P	A	P	P	P	P	P	A	P	P	P	P	P	A	P	P	P	P	P	P	P	P	P	P	P
22	14131A1203	AKHILAKRISHNAN	P	A	A	P	P	A	P	P	A	P	P	A	P	P	A	P	P	A	P	P	P	P	P	P	P	P	P	P
23	14131A1204	HATHA LIPYANITHI	P	P	P	A	P	P	P	A	P	P	P	A	P	P	P	P	A	P	P	P	P	P	P	P	P	P	P	P
24	14131A1205	SHASHIBHARANI MOHITHI	P	P	P	P	P	P	P	P	P	P	P	P	P	P	P	P	P	P	P	P	P	P	P	P	P	P	P	P
25	14131A1206	CHAITANYA SUSHI MANI	P	P	P	P	A	P	P	P	P	P	P	P	P	P	P	P	P	P	P	P	P	P	P	P	P	P	P	P
26	14131A1207	SHRINIDHAR	A	P	P	P	A	P	P	P	P	P	P	P	P	P	P	P	P	P	P	P	P	P	P	P	P	P	P	P
27	14131A1208	SHYAMINI SARDHA	P	P	P	P	A	P	P	P	P	P	P	P	P	P	P	P	P	P	P	P	P	P	P	P	P	P	P	P
28	14131A1209	SRIBHARANI SURESH	P	A	P	P	A	P	P	P	P	P	P	A	P	P	P	P	A	P	P	P	P	P	P	P	P	P	P	P

Handwritten signature

Vysapuri, Bandlaguda Post:Keshavgiri,

Hyderabad-500 005, TELANGANA INDIA
Tel: 040-64596979,8978380692 Fax: 040-24455003
E-mail: a3hod.it@gmail.com,
Website: www.mist.ac.in,

MAHAVEER

INSTITUTE OF SCIENCE & TECHNOLOGY

Approved by AICTE, Affiliated to JNTUF, Hyd.



DEPARTMENT OF INFORMATION TECHNOLOGY

Date: 25-01-2018

To,

The principal,
MIST,
Hyderabad.

Sub: Proposal for Add-on Course-Reg.

Dear Sir,

We are going to conduct two weeks workshop on **Java Certification** programme. We require your approval to go head for further proceeding and hope to get an opportunity to serve you the best.

With thanks and Regards

Head of Department
Department of Information Technology
Mahaveer Institute of Science & Technology
Bandlaguda, Hyd-500 005

K. Srinivas
PRINCIPAL
MAHAVEER
INSTITUTE OF SCIENCE & TECHNOLOGY
Bandlaguda, Hyd-500 005.

Vysapuri, Bandlaguda Post:Keshavgi,ri,

Hyderabad-500 005, TELANGANA INDIA
Tel: 040-64596979,8978380692 Fax: 040-24455003
E-mail: e3hod.it@gmail.com,
Website: www.mist.ac.in,

MAHAVEER

INSTITUTE OF SCIENCE & TECHNOLOGY

Approved by AICTE, Affiliated to JNTUH,Hyd.



DEPARTMENT OF INFORMATION TECHNOLOGY

Date: 01-02-2018

CIRCULAR

Technical Trainings for II & IV B, Tech students are starting from 12-02-2018 onwards. All HODs and placements coordinators have to manage the trainings and ensure 95% attendance all through the sessions.

All mentors need to send the compiled feedback report to HOD at e3hod@gmail.com daily. Mentors are advised to take care of PNR (Students not participating in training).

Agenda: Java Certification programme

Design and Development of Curriculum for Add on Course:

Name of the Faculty: 1.CH B NAGALAKSHMI
2.A.NANDA GOPAL REDDY
3.KBVK NAGA SREE

[Handwritten Signature]
HOD.

Head of Department
Department of Information Technology
Mahaveer Institute of Science & Technology
Bandlaguda, Hyderabad-500 005

[Handwritten Signature]
PRINCIPAL
MAHAVEER
INSTITUTE OF SCIENCE & TECHNOLOGY
Bandlaguda, Hyd-500 005.

Vysapuri, Bandlaguda Post:Keshavgiri,

Hyderabad-500 005, TELANGANA INDIA
Tel: 040-64596979,8978380692,Fax: 040-24455003
E-mail: a3hod.it@gmail.com,
Website: www.mist.ac.in,

MAHAVEER

INSTITUTE OF SCIENCE & TECHNOLOGY

Approved by AICTE, Affiliated to JNTUH,Hyd.



DEPARTMENT OF INFORMATION TECHNOLOGY

SYLLABUS FOR Java Certification programme

SNO	TOPIC COVERED	DURATION
1	Introduction	3
2	OOPS (Object Oriented Programming & Systems)	3
3	STRING Manipulation	3
4	Array	3
5	Packages	3
6	Exception Handling	3
7	I/O Streams	3
8	Multithreading	3
9	Wrapper Classes	3
10	Inner Classes	3
11	Collection Frame Work	3
12	AWT	3
13	SWING (JFC)	3

[Handwritten Signature]
HOD-IT

Head of Department
Department of Information Technology
Mahaveer Institute of Science & Technology

[Handwritten Signature]
PRINCIPAL
MAHAVEER
INSTITUTE OF SCIENCE & TECHNOLOGY
Bandlaguda Post-500 005

Vysapuri, Bandlaguda Post:Keshavgi,ri,

MAHAVEER

INSTITUTE OF SCIENCE & TECHNOLOGY

Approved by AICTE, Affiliated to JNTUH,Hyd.



Hyderabad-500 005, TELANGANA INDIA

Tel: 040-64596979,8978380692,Fax: 040-24455003

E-mail: e3hod.it@gmail.com,

Website: www.mist.ac.in,

DEPARTMENT OF INFORMATION TECHNOLOGY

LIST OF REGISTERED STUDENTS FOR Java Certification programme

SNO	HALL TICKET NO	NAME OF THE STUDENT
1	14E31A1202	AREKATLA DIVYA
2	14E31A1204	B SAI KIRAN REDDY
3	14E31A1205	BANDHYALA AKSHAY REDDY
4	14E31A1206	DEVARANENI SRAVANI
5	14E31A1208	GANGIDI ANUSHA
6	14E31A1209	GANTE SANTHOSH
7	14E31A1210	GUJJA SAI AKHIL
8	14E31A1211	KAVETI LALANI
9	14E31A1212	KORASIKA SAI KIRAN
10	14E31A1214	KURNAMONI DILIP
11	14E31A1215	MAHENDER SINGH
12	14E31A1216	MAMIDIPALLY MOUNIKA
13	14E31A1218	NALIMELA VINAY REDDY
14	14E31A1220	NARAGONI SHIVA VENKATA SAI
15	14E31A1221	PRANATHI PADAKANTI
16	14E31A1222	RAMA RAKESH
17	14E31A1223	RAMIDI KAVYA REDDY
18	14E31A1224	SREERAMINENI SRUJANA
19	14E31A1225	THIPPARAPU SRIVANI
20	14E31A1227	VEERAMREDDY MANASA
21	16E31A1202	ADURLA PAVAN
22	16E31A1203	AKULA PRANATHI
23	16E31A1204	ANDE NAVEEN KUMAR
24	16E31A1206	CHENNUPATI CHAITANYA
25	16E31A1207	CHIDIMILLA ASHWIDHI
26	16E31A1208	DEVARANENI SANJAY
27	16E31A1211	GOLI ARUN KUMAR
28	16E31A1212	KARING DINESH
29	16E31A1213	KEERTHI SAI KRISHNA
30	16E31A1214	KURUVA VAISHNAVI
31	16E31A1217	NANDIKANTI TEJASHWINI
32	16E31A1218	PADALA NAVIKANTH CHARY
33	16E31A1219	PAIPATI SHILPA REDDY
34	16E31A1220	PEDDISSETTY NAGA ANUSHA
35	16E31A1221	PERUMALLA KRANTHI KUMAR
36	16E31A1223	R VAISHNAVI
37	16E31A1224	SAMREEN SULTANA

Keshavgi
PRINCIPAL
MAHAVEER
INSTITUTE OF SCIENCE & TECHNOLOGY
Bandlaguda, Hyderabad-500 005.

Vysapuri, Bandlaguda Post:Keshavgiri,

Hyderabad-500 005, TELANGANA INDIA
Tel: 040-64596979,8978380692,Fax: 040-24455003
E-mail: e3hod.it@gmail.com,
Website: www.mist.ac.in,

MAHAVEER

INSTITUTE OF SCIENCE & TECHNOLOGY

Approved by AICTE, Affiliated to JNTUH,Hyd.



DEPARTMENT OF INFORMATION TECHNOLOGY

38	16E31A1225	SRIDHARA GAYATHRI
39	16E31A1227	THADIPARTHI THEJASWINI
40	16E31A1228	VADHADIYA SRINA
41	16E31A1229	VATTIKUTI MAHESH
42	16E31A1230	VITTEDI PAVAN REDDY
43	16E31A1231	YASA ABHINAYA

Head of Department
Department of Information Technology
The Institute of Science & Technology
Vysapuri Post, Keshavgiri
Hyderabad

PRINCIPAL
MAHAVEER
INSTITUTE OF SCIENCE & TECHNOLOGY
Bandlaguda, Hyd-500 005.

Wysapuri, Bandlaguda Post:Keshavgiri,

Hyderabad-500 005, TELANGANA INDIA
Tel: 040-64596979,8978380692, Fax: 040-24455003
E-mail: e3hod.it@gmail.com,
Website: www.mist.ac.in,

MAHAVEER

INSTITUTE OF SCIENCE & TECHNOLOGY

Approved by AICTE, Affiliated to JNTUH,Hyd.



DEPARTMENT OF INFORMATION TECHNOLOGY

Java Certification programme QUESTION PAPER

Duration: 120 Minutes

10 X 2 = 20 Marks

Answer the following all questions. Each question carries 2 marks.

- Q1. Explain JDK, JRE and JVM?
- Q2. Explain public static void main(String args[]) in Java
- Q3. Why Java is platform independent?
- Q4. Why Java is not 100% Object-oriented?
- Q5. What are wrapper classes in Java?
- Q6. What are constructors in Java?
- Q7. What is singleton class in Java and how can we make a class singleton?
- Q8. What is the difference between Array list and vector in Java?
- Q9. What is the difference between equals() and == in Java?
- Q10. What are the differences between Heap and Stack Memory in Java?

[Handwritten Signature]
HOD-IT

Head of Department
Department of Information Technology
Institute of Science & Technology

[Handwritten Signature]

PRINCIPAL
MAHAVEER
INSTITUTE OF SCIENCE & TECHNOLOGY
Bandlaguda, Hyd-500 005.

Vysapuri, Bandlaguda Post:Keshavgirl,

Hyderabad-500 005, TELANGANA INDIA
Tel: 040-64596979,8978380692 Fax: 040-24455003
E-mail: a3hod.it@gmail.com,
Website: www.mist.ac.in,

MAHAVEER

INSTITUTE OF SCIENCE & TECHNOLOGY

Approved by AICTE, Affiliated to JNTUH,Hyd.



DEPARTMENT OF INFORMATION TECHNOLOGY

RESULT SHEET FOR Java Certification programme REGISTERED STUDENTS

SNO	HALL TICKET NO	NAME OF THE STUDENT	MARKS (20)	RESULT
1	14E31A1202	AREKATLA DIVYA	20	PASS
2	14E31A1204	B SAI KIRAN REDDY	19	PASS
3	14E31A1205	BANDHYALA AKSHAY REDDY	20	PASS
4	14E31A1206	DEVARANENI SRAVANI	18	PASS
5	14E31A1208	GANGIDI ANUSHA	20	PASS
6	14E31A1209	GANTE SANTHOSH	20	PASS
7	14E31A1210	GUJJA SAI AKHIL	16	PASS
8	14E31A1211	KAVETI LALANI	20	PASS
9	14E31A1212	KORASIKA SAI KIRAN	20	PASS
10	14E31A1214	KURNAMONI DILIP	17	PASS
11	14E31A1215	MAHENDER SINGH	20	PASS
12	14E31A1216	MAMIDIPALLY MOUNIKA	20	PASS
13	14E31A1218	NALIMELA VINAY REDDY	16	PASS
14	14E31A1220	NARAGONI SHIVA VENKATA SAI	20	PASS
15	14E31A1221	PRANATHI PADAKANTI	20	PASS
16	14E31A1222	RAMA RAKESH	18	PASS
17	14E31A1223	RAMIDI KAVYA REDDY	20	PASS
18	14E31A1224	SREERAMINENI SRUJANA	19	PASS
19	14E31A1225	THIPPARAPU SRIVANI	20	PASS
20	14E31A1227	VEERAMREDDY MANASA	18	PASS
21	16E31A1202	ADURLA PAVAN	20	PASS
22	16E31A1203	AKULA PRANATHI	19	PASS
23	16E31A1204	ANDE NAVEEN KUMAR	20	PASS
24	16E31A1206	CHENNUPATI CHAITANYA	18	PASS
25	16E31A1207	CHIDIMILLA ASHWIDHI	20	PASS
26	16E31A1208	DEVARANENI SANJAY	20	PASS
27	16E31A1211	GOLI ARUN KUMAR	16	PASS
28	16E31A1212	KARING DINESH	20	PASS
29	16E31A1213	KEERTHI SAI KRISHNA	20	PASS
30	16E31A1214	KURUVA VAISHNAVI	17	PASS
31	16E31A1217	NANDIKANTI TEJASHWINI	20	PASS
32	16E31A1218	PADALA NAVIKANTH CHARY	20	PASS
33	16E31A1219	PAIPATI SHILPA REDDY	16	PASS
34	16E31A1220	PEDDISSETTY NAGA ANUSHA	20	PASS
35	16E31A1221	PERUMALLA KRANTHI KUMAR	20	PASS
36	16E31A1223	R VAISHNAVI	18	PASS
37	16E31A1224	SAMREEN SULTANA	20	PASS
38	16E31A1225	SRIDHARA GAYATHRI	19	PASS
39	16E31A1227	THADIPARTHI THEJASWINI	20	PASS

Keshav
PRINCIPAL
MAHAVEER
INSTITUTE OF SCIENCE & TECHNOLOGY
Bandlaguda, Hyd-50002

Wapuri, Bandlaguda Post:Keshavgirl,

Hyderabad-500 005, TELANGANA INDIA
Tel: 040-64596979,8978380692,Fax: 040-24455003
E-mail: e3hod.it@gmail.com,
Website: www.mist.ac.in,

MAHAVEER

INSTITUTE OF SCIENCE & TECHNOLOGY

Approved by AICTE, Affiliated to JNTUH,Hyd.



DEPARTMENT OF INFORMATION TECHNOLOGY

40	16E31A1228	VADHADIYA SRINA	18	PASS
41	16E31A1229	VATTIKUTI MAHESH	20	PASS
42	16E31A1230	VITTEDI PAVAN REDDY	20	PASS
43	16E31A1231	YASA ABHINAYA	16	PASS

No. of students Registered:43

No. of students Passed:43

No. of students failed:NIL

Principal
Department of Information Technology
Mahaveer Institute of Science & Technology
Bandlaguda, Hyd-500 005

K. S. S.
PRINCIPAL
MAHAVEER
INSTITUTE OF SCIENCE & TECHNOLOGY
Bandlaguda, Hyd-500 005

Vysapuri, Bandlaguda Post, Keshavgi,

Hyderabad-500 005, TELANGANA INDIA

Tel: 040-64596979, 8978380692 Fax: 040-24455003

E-mail: e3hod.it@gmail.com,

Website: www.mist.ac.in,

MAHAVEER

INSTITUTE OF SCIENCE & TECHNOLOGY

Approved by AICTE, Affiliated to JNTUH, Hyd.



DEPARTMENT OF INFORMATION TECHNOLOGY

SUMMARY REPORT OF Java Certification Programme

Java is one of the most popular programming languages used to create Web applications and platforms. It was designed for flexibility, allowing developers to write code that would run on any machine, regardless of architecture or platform.

Java is designed to be concurrent, class-based and object-oriented, as well as a computing platform first released by Sun Microsystems in 1995. An enormous amount of applications and websites will not work unless you have Java installed, and more are created every day.

Java is advertised, and esteemed for its fast performance, security, and reliability.

COORDINATOR

Copy to:

1. Department Notice Board
2. Principal for Information
3. Committee Members (Academic)

Handwritten signature in green ink
PRINCIPAL
MAHAVEER
INSTITUTE OF SCIENCE & TECHNOLOGY
Bandlaguda, hyd-500 005

Vysapuri, Bandlaguda Post:Keshavgiri,
Hyderabad-500 005, Telangana INDIA
Tel: 040-64596979,20020773, Fax: 040-24455003
E-mail: principal.mahaveer@gmail.com,
Website: www.mist.ac.in,

MAHAVEER

INSTITUTE OF SCIENCE & TECHNOLOGY
Approved by AICTE, Affiliated to JNTUH,Hyd.



DEPARTMENT OF AERONAUTICAL ENGINEERING

PROPOSAL LETTER

Hyderabad,

16/08/2017.

To,
The principal,
MIST,
Hyderabad.

Sub: Proposal for two weeks workshop on Computer Aided Design CATIA - Intermediate

–Reg,

Dear Sir,

We are working as Asst professor in the department of AERONAUTICAL ENGINEERING.
Sir, we are going to conduct three weeks workshop Computer Aided Design CATIA - Intermediate. We require your approval to go head for further proceeding and hope to get an opportunity to serve you the best.

With thanks and Regards

K. Srinivas
PRINCIPAL
MAHAVEER
INSTITUTE OF SCIENCE & TECHNOLOGY
Bandlaguda, Hyd-500 005.

From,
AERO Department
Mist,
Bandlaguda,

A. D. Srinivas



DEPARTMENT OF AERONAUTICAL ENGINEERING

Date: 22.08.2017

CIRCULAR

Technical Training for III B. Tech students are starting from 22-08-2017 onwards. All HODs and Placements coordinators have to manage the trainings and ensure 95% attendance all through the sessions.

All Mentors need to send the compiled feedback report to A Ranga Reddy, HOD at e3hod.aero@gmail.com daily.

Agenda: 1. Computer Aided Design CATIA - Intermediate

Prof RANGA REDDY
HOD

Course Designed By

Y RAGHUVeer

G RAJESH KUMAR

PRINCIPAL
MAHAVEER
INSTITUTE OF SCIENCE & TECHNOLOGY
Bandlaguda, Hyd-500 005.



SYLLABUS

Course: Computer Aided Design CATIA – Intermediate

1: Introduction to Catia V5

- Workbenches
- Toolbars
- Specification Tree
- Compass
- Mouse Usage
- File Operations

2: Drawing Sketches in the Sketcher

- Workbench-I Invoking the Sketcher Workbench
- Units, Grid Settings
- Construction and Standard elements
- Drawing Sketch objects I
- Inferred Constraints
- Exiting the Sketcher Workbench
- View Manipulation
- Chapter 2 Tutorials 1-3 Assignment

3: Drawing Sketches in the Sketcher

- Workbench-II Drawing Sketch Objects II
- Modifying sketch Objects
- Sketch Transformations
- Chapter 3 Tutorials 1-3, Exercise 1 Assignment

4: Constraining Sketches and Creating Base Features

- Constraining Sketches
- Geometric Constraints
- Dimensional Constraints



- Sketch Analysis
- Creating an Extruded Solid Using the Pad Feature
- Creating a Revolved Solid Using the Shaft Feature

5: Reference Elements and Sketch-Based Features

- Reference Elements
- Drafted Filleted Pad Features
- Multi-Pad Features
- Pocket Features
- Drafted Filleted Pocket
- Multi-Pocket Features
- Groove
- Extruding and Revolving Faces
- Projecting 3D Elements
- Chapter 5 Tutorial 1-3 Assignment

Handwritten signature

PRINCIPAL
MAHAVEER
INSTITUTE OF SCIENCE & TECHNOLOGY
Bandlaguda, Hyderabad-500 005.



Computer Aided Design CATIA Course

STUDENT LIST 2017-18

S.No	Hall Ticket No	Name of the Candidate	YEAR
1	15E31A2101	AARE BHARATH REDDY	III
2	15E31A2102	BANDI PRIYANKA	III
3	15E31A2104	BHOOMOLLA DHRUVA KUMAR GOUD	III
4	15E31A2105	CHILIVERU PRANAY	III
5	15E31A2108	DEVARAKONDA PURNACHANDER	III
6	15E31A2109	LONKA VAMSHI KRISHNA	III
7	15E31A2110	MALA HARICHANDAN	III
8	15E31A2111	MOODU RAJKUMAR	III
9	15E31A2112	N SRAVAN KUMAR	III
10	15E31A2114	NIDHI SINGH	III
11	15E31A2115	PANJAGUTTA PRIYANKA	III
12	15E31A2117	SAMALA MANISH	III
13	15E31A2119	VAJRAPU NARESH	III
14	15E31A2120	ZAMAN KHAN	III
15	15E31A2121	YARLAGADDA BHARAT TEJ	III
16	16E35A2101	SETTI SAI GOPI KRISHNA	III



Technical Training Exam on Computer Aided Design CATIA Software (A.Y-2017-18)

2x10=20 Marks

Answer All the Questions

1. Draw the given 2D model into 3D model by using CATIA

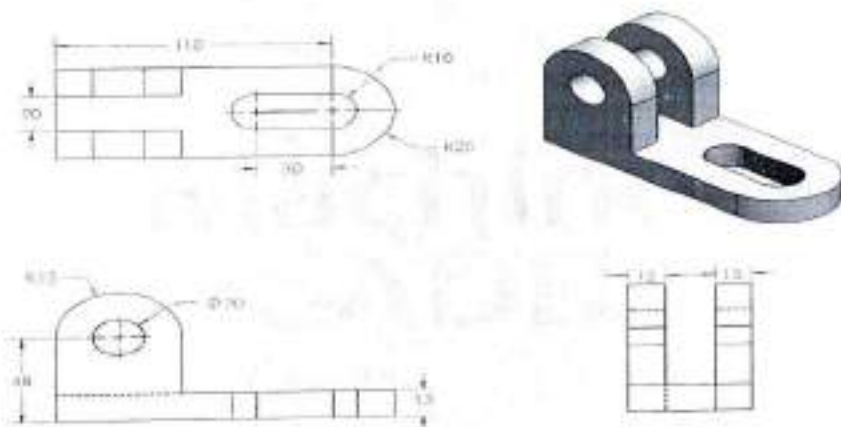

2. Draw the given 2D model into 3D model by using Auto CAD.

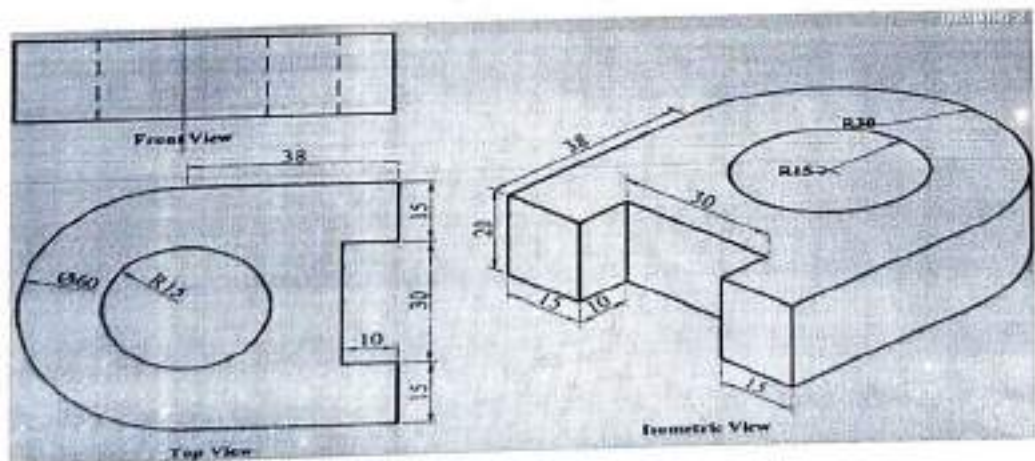



Computer Aided Design CATIA Course

Training student marks list 2017-18

S.No	Hall Ticket No	Name of the Candidate	marks	Pass/
1	15E31A2101	AARE BHARATH REDDY	16	PASS
2	15E31A2102	BANDI PRIYANKA	15	PASS
3	15E31A2104	BHOOMOLLA DHRUVA KUMAR GOUD	16	PASS
4	15E31A2105	CHILIVERU PRANAY	17	PASS
5	15E31A2108	DEVARAKONDA PURNACHANDER	15	PASS
6	15E31A2109	LONKA VAMSHI KRISHNA	16	PASS
7	15E31A2110	MALA HARICHANDAN	18	PASS
8	15E31A2111	MOODU RAJKUMAR	19	PASS
9	15E31A2112	N SRAVAN KUMAR	18	PASS
10	15E31A2114	NIDHI SINGH	17	PASS
11	15E31A2115	PANJAGUTTA PRIYANKA	20	PASS
12	15E31A2117	SAMALA MANISH	17	PASS
13	15E31A2119	VAJRAPU NARESH	15	PASS
14	15E31A2120	ZAMAN KHAN	16	PASS
15	15E31A2121	YARLAGADDA BHARAT TEJ	17	PASS
16	16E35A2101	SETTI SAI GOPI KRISHNA	15	PASS

Kishu
PRINCIPAL
MAHAVEER
INSTITUTE OF SCIENCE & TECHNOLOGY
BANDLAGUDA POST, VYSAPURI, HYD-500 005

S. Dornachary
HOD

MAHAVEER INSTITUTE OF SCIENCE AND TECHNOLOGY
AERONAUTICAL ENGINEERING
COURSE ATTENDANCE LIST

S NO	HT NO	NAME	Date	22	23	24	25	26	27	28	29	30	31	1	5	6
1	15E31A2101	AARE BHARATH REDDY		P	P	P	P	P	P	P	P	P	P	P	P	P
2	15E31A2102	BANDI PRIYANKA		P	P	P	P	P	P	P	P	P	P	P	P	P
3	15E31A2104	BHOOMOLLA DHRUVA KUMAR GOUD		P	P	P	P	P	P	P	P	P	P	P	P	P
4	15E31A2105	CHILIVERU PRANAY		P	P	P	P	P	P	P	P	P	P	P	P	P
5	15E31A2108	DEVARAKONDA PURNACHANDER		P	P	P	P	P	P	P	P	P	P	P	P	P
6	15E31A2109	LONKA VAMSHI KRISHNA		P	P	P	P	P	P	P	P	P	P	P	P	P
7	15E31A2110	MALA HARICHANDAN		P	P	P	P	P	P	P	P	P	P	P	P	P
8	15E31A2111	MOODU RAJKUMAR		P	P	P	P	P	P	P	P	P	P	P	P	P
9	15E31A2112	N SRAVAN KUMAR		P	P	P	P	P	P	P	P	P	P	P	P	P
10	15E31A2114	NIDHI SINGH		P	P	P	P	P	P	P	P	P	P	P	P	P
11	15E31A2115	PANJAGUTTA PRIYANKA		P	P	P	P	P	P	P	P	P	P	P	P	P
12	15E31A2117	SAMALA MANISH		P	P	P	P	P	P	P	P	P	P	P	P	P
13	15E31A2119	VAJRAPU NARESH		P	P	P	P	P	P	P	P	P	P	P	P	P
14	15E31A2120	ZAMAN KHAN		P	P	P	P	P	P	P	P	P	P	P	P	P
15	15E31A2121	YARLAGADDA BHAKAT TEJ		P	P	P	P	P	P	P	P	P	P	P	P	P
16	16E35A2101	SETTI SAI GOPI KRISHNA		P	P	P	P	P	P	P	P	P	P	P	P	P

A. Annamalai

HOD

K. Subudh
 PRINCIPAL
 MAHAVEER
 INSTITUTE OF SCIENCE & TECHNOLOGY
 Yarlagadda, Hydrabad-500070



Course: Computer Aided Design CATIA – Intermediate

SUMMARY REPORT

CATIA Training. Computer Aided Design (CAD) is the use of computer software to design a product or an object. Computer Aided Engineering is the use of computer software to solve engineering problems and analyze products created using CAD. CATIA is an acronym for Computer Aided Three-dimensional Interactive Application

Overview: The Wireframe and Surface course is designed to teach you the basic wireframe and surface commands in CATIA V5-6 R2012. You more. We will learn how to create lines, points and planes in 3D space. You'll also learn how to create extruded and revolved surfaces from wireframe geometry and sketches.

N. Anand
HOD

Khanal
PRINCIPAL
MAHAVEER
INSTITUTE OF SCIENCE & TECHNOLOGY
Vysapuri, Bandlaguda Post-Keshavgiri, Hyderabad-500 005

Vysapuri, Bandlaguda Post:Keshavgiri,
Hyderabad-500 005, Telangana INDIA
Tel: 040-64596979,20020773, Fax: 040-24455003
E-mail: principal.mahaveer@gmail.com
Website: www.mist.ac.in,

MAHAVEER

INSTITUTE OF SCIENCE & TECHNOLOGY

Approved by AICTE, Affiliated to JNTU,Hyd.



CERTIFICATE OF COURSE COMPLETION

This certificate is presented to BANDI PRIYANKA of MIST, who has successfully completed technical training course on "Computer Aided Design CATIA - Intermediate" held from 22-08-2017 to 06-09-2017 and found the student performance to be excellent.



ESTD : 2001

A RANGA REDDY

HOD (AERO)

K. Sankar
PRINCIPAL
MAHAVEER
INSTITUTE OF SCIENCE & TECHNOLOGY
Bandlaguda, Hyd-500 005

Vysapuri, Bandlaguda Post:Keshavgi,

Hyderabad-500 005, TELANGANA INDIA
Tel: 040-64596979,8978380692,Fax: 040-24455003
E-mail: e3hod.it@gmail.com,
Website: www.mist.ac.in,

MAHAVEER
INSTITUTE OF SCIENCE & TECHNOLOGY
Approved by AICTE, Affiliated to JNTUH,Hyd.



DEPARTMENT OF HUMANITIES AND SCIENCES

Date: 20-09-17

To,
The principal,
MIST ,
Hyderabad.

Sub: Proposal for Add-on-course-Reg
Dear sir,

We are going to conduct Add-On course on Ultrasonics. we require your approval to go head for further proceeding and hope to get an opportunity to serve you the best.

With thanks and Regards



PRINCIPAL
MAHAVEER
INSTITUTE OF SCIENCE & TECHNOLOGY
Bandlaguda, Hyd-500 005.

HOD
Department of Humanities & Sciences
Mahaveer Institute of Science & Technology,
HYDERABAD

Vysapuri, Bandlaguda Post:Keshavgiri,

Hyderabad-500 005, TELANGANA INDIA
Tel: 040-64596979,8978380692,Fax: 040-24455003
E-mail: e3hod.it@gmail.com,
Website: www.mist.ac.in,

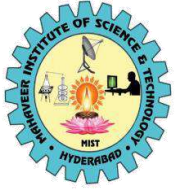
MAHAVEER
INSTITUTE OF SCIENCE & TECHNOLOGY
Approved by AICTE, Affiliated to JNTUH,Hyd.



DEPARTMENT OF HUMANITIES AND SCIENCES

Date: 25-09-17

CIRCULAR

CRASH COURSE FOR I B.Tech students are starting from 27-09-17 onwards. All HODs and placements coordinators have to manage the trainings and ensure 95% attendance all through the sessions.

All mentors need to send the compiled feedback report to HOD at e3hod@gmail.com daily. Mentors are advised to take care of PNR (Students not participating in training).

Agenda: **ULTRASONICS**

Design and Development of Curriculum for Add on Course

Name of Faculty: 1.Dr.K.MADHUSUDHANA
2.P.SRINIVAS KUMAR



PRINCIPAL
MAHAVEER
INSTITUTE OF SCIENCE & TECHNOLOGY
Bandlaguda, Hyd-500 005.

HOD
Department of Humanities & Sciences
Mahaveer Institute of Science & Technology,
HYDERABAD

Vysapuri, Bandlaguda Post:Keshavgiri,

Hyderabad-500 005, TELANGANA INDIA
Tel: 040-64596979,8978380692,Fax: 040-24455003
E-mail: e3hod.it@gmail.com,
Website: www.mist.ac.in,

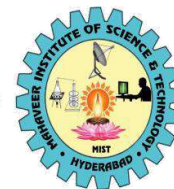
MAHAVEER
INSTITUTE OF SCIENCE & TECHNOLOGY
Approved by AICTE, Affiliated to JNTUH,Hyd.



DEPARTMENT OF HUMANITIES AND SCIENCES

SYLLABUS FOR ULTRASONICS

SNO	TOPIC COVERED	DURATION
1	Introduction, Fundamentals of Ultrasonics	3
2	Features of Ultrasonic waves	3
3	Generation of Ultrasonics waves	3
4	Detection of Ultrasonic waves	3
5	Cavitations	3
6	Determination of velocity in a Liquid	3
7	Determination of velocity in Solids	3
8	Applications of Ultrasonics: Industrial, Medical, Marine	3



PRINCIPAL
MAHAVEER
INSTITUTE OF SCIENCE & TECHNOLOGY
Bandlaguda, Hyd-500 005.

HOD
Department of Humanities & Sciences
Mahaveer Institute of Science & Technology,
HYDERABAD

Vysapuri, Bandlaguda Post:Keshavgi,

Hyderabad-500 005, TELANGANA INDIA
Tel: 040-64596979,8978380692,Fax: 040-24455003
E-mail: e3hod.it@gmail.com,
Website: www.mist.ac.in,

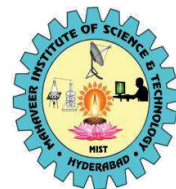
MAHAVEER
INSTITUTE OF SCIENCE & TECHNOLOGY
Approved by AICTE, Affiliated to JNTUH,Hyd.



DEPARTMENT OF HUMANITIES AND SCIENCES

LIST OF REGISTERED STUDENTENS FOR ULTRASONICS

SNO	HOLL TICKET NO	NAME OF THE STUDENT
1	17E31A0406	ARAVIND JOSHI
2	17E31A0411	BOORAM SAI ROSHAN
3	17E31A0416	CHIRLA AKHILA
4	17E31A0438	KATTAGURI SHIVANI
5	17E31A0465	V RAHUL
6	17E31A0466	VEMULA AVINASH
7	17E31A0468	VISLAVATH SHIVA
8	17E31A0207	CHIDUMULA APARNA
9	17E31A0214	KATAKAM GOPI
10	17E31A0225	SYED ZAFAR
11	17E31A0228	V SWATHI
12	17E31A1207	C PRASHANSHA
13	17E31A1230	SAMA NAVYA
14	17E31A0508	CHELLOJU ANUSHA
15	17E31A0518	JAMADANDA MANISH
16	17E31A0528	LONE HARISH
17	17E31A0548	THUKKANI SHREYA
18	17E31A0105	BHUKYA RAJU
19	17E31A0114	ESSAM KAVYA
20	17E31A0304	BANGARI MOHAN
21	17E31A0315	JARPLA SANDEEP
22	17E31A0324	MALLETHULA RAHUL
23	17E31A2108	G SRIKANTH
24	17E31A2116	KUDIKALA ANOSH
25	17E31A2127	SAMBARU VIKAS

Kanish

PRINCIPAL
MAHAVEER
INSTITUTE OF SCIENCE & TECHNOLOGY
Bandlaguda, Hyd-500 005.

Vysapuri, Bandlaguda Post:Keshavgiri,

Hyderabad-500 005, TELANGANA INDIA

Tel: 040-64596979,8978380692,Fax: 040-24455003

E-mail: e3hod.it@gmail.com,

Website: www.mist.ac.in,

MAHAVEER
INSTITUTE OF SCIENCE & TECHNOLOGY
Approved by AICTE, Affiliated to JNTUH,Hyd.



DEPARTMENT OF HUMANITIES AND SCIENCES

ULTRASONICS QUESTION PAPER

DURATION:120 MINUTES

MAX.MARKS 50

PART-A

ANSWER ANY TWO QUESTION.

2*15=30

- 1.EXPLAIN GENERATION OF ULTRASONICS?
- 2.EXPLAIN DETECTION OF ULTRA SONICS?
- 3.DISCUSS DIFFERENT METHODS TO FIND VELOCITY OF ULTRASONICS?

PART-B

ANSWER ANY TWO QUESTION.

2*10=20

- 4.DISCUSS APPLICATIONS OF ULTRASONICS?
- 5.EXPLAIN PULSE ECHO OVERLOP TECHUNIQUE?
6. WRITE THE DIFFRENCES BETWEEN ULTRASONICS AND SOWD

PRINCIPAL
MAHAVEER
INSTITUTE OF SCIENCE & TECHNOLOGY
Bandlaguda, Hyd-500 005.

Vysapuri, Bandlaguda Post:Keshavgiri,

Hyderabad-500 005, TELANGANA INDIA

Tel: 040-64596979,8978380692,Fax: 040-24455003

E-mail: e3hod.it@gmail.com,

Website: www.mist.ac.in,

MAHAVEER
INSTITUTE OF SCIENCE & TECHNOLOGY

Approved by AICTE, Affiliated to JNTUH,Hyd.

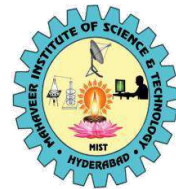

DEPARTMENT OF HUMANITIES AND SCIENCES

RESULT SHEET FOR ULTRASONICS REGISTERED STUDENTS

SNO	HOLL TICKET NO	NAME OF THE STUDENT	MARKS(20)	RESULT
1	17E31A0406	ARAVIND JOSHI	20	PASS
2	17E31A0411	BOORAM SAI ROSHAN	19	PASS
3	17E31A0416	CHIRLA AKHILA	20	PASS
4	17E31A0438	KATTAGURI SHIVANI	18	PASS
5	17E31A0465	V RAHUL	20	PASS
6	17E31A0466	VEMULA AVINASH	19	PASS
7	17E31A0468	VISLAVATH SHIVA	18	PASS
8	17E31A0207	CHIDUMULA APARNA	20	PASS
9	17E31A0214	KATAKAM GOPI	18	PASS
10	17E31A0225	SYED ZAFAR	18	PASS
11	17E31A0228	V SWATHI	19	PASS
12	17E31A1207	C PRASHANSHA	19	PASS
13	17E31A1230	SAMA NAVYA	20	PASS
14	17E31A0508	CHELLOJU ANUSHA	20	PASS
15	17E31A0518	JAMADANDA MANISH	20	PASS
16	17E31A0528	LONE HARISH	19	PASS
17	17E31A0548	THUKKANI SHREYA	19	PASS
18	17E31A0105	BHUKYA RAJU	18	PASS
19	17E31A0114	ESSAM KAVYA	18	PASS
20	17E31A0304	BANGARI MOHAN	20	PASS
21	17E31A0315	JARPLA SANDEEP	18	PASS
22	17E31A0324	MALLETHULA RAHUL	17	PASS
23	17E31A2108	G SRIKANTH	16	PASS
24	17E31A2116	KUDIKALA ANOSH	20	PASS
25	17E31A2127	SAMBARU VIKAS	19	PASS

No.of students registred:20

No.of students passed :20

No.of students failed :Nil



PRINCIPAL
MAHAVEER
INSTITUTE OF SCIENCE & TECHNOLOGY
Bandlaguda, Hyd-500 005.

HOD
Department of Humanities & Sciences
Mahaveer Institute of Science & Technology,
HYDERABAD

Vysapuri, Bandlaguda Post:Keshavgi,

Hyderabad-500 005, TELANGANA INDIA
Tel: 040-64596979,8978380692,Fax: 040-24455003
E-mail: e3hod.it@gmail.com,
Website: www.mist.ac.in,

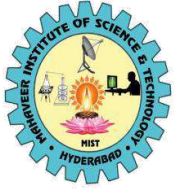
MAHAVEER
INSTITUTE OF SCIENCE & TECHNOLOGY
Approved by AICTE, Affiliated to JNTUH,Hyd.



DEPARTMENT OF HUMANITIES AND SCIENCES

SUMMARY REPORT OF ULTRASONICS

Ultrasonics, Vibrational or stress waves in elastic media that have a frequency above 20 kilohertz, the highest frequency of sound waves that can be detected by the human ear. They can be generated or detected by piezoelectric transducers (*see* piezoelectricity). High-power ultrasonics produce distortion in a medium; applications include ultrasonic welding, drilling, irradiation of fluid suspensions (as in wine clarification), cleaning of surfaces (such as jewelry), and disruption of biological structures. Low-power ultrasonic waves do not cause distortions; uses include sonar, structure testing, and medical imaging and diagnosis. Some animals, including [bats](#), employ ultrasonic echolocation for navigation.

COPY TO:

- 1.Department notice board.
- 2.Principal for information
- 3.committee members (academic)

PRINCIPAL
MAHAVEER
INSTITUTE OF SCIENCE & TECHNOLOGY
Bandlaguda, Hyd-500 005.

MAHAVEER INSTITUTE OF SCIENCE & TECHNOLOGY
DEPARTMENT OF HUMANITIES AND SCIENCE
ULTRASONICS ATTENDANCE SHEET

S.NO	HT NO	NAME OF THE STUDENT	1	2	3	4	5	6	7	8	9	10	11	12	13	14	15	16	17	18	19	20
1	17E31A0406	ARAVIND KISHI	P	P	P	P	P	P	A	P	P	P	P	P	P	P	P	A	P	P	P	P
2	17E31A0411	BOORAM SAI ROSHAN	P	P	P	A	P	P	P	P	P	P	P	P	P	A	P	P	P	P	P	P
3	17E31A0416	CHIRLA AKHILA	P	P	P	P	P	P	A	P	P	P	P	P	P	P	P	A	P	P	P	P
4	17E31A0438	KATTAGURI SHIVANI	P	P	P	P	P	P	P	A	P	P	P	P	P	P	P	A	P	P	P	P
5	17E31A0465	V RAHUL	P	P	P	P	P	P	P	A	P	P	P	P	P	P	P	A	P	P	P	P
6	17E31A0466	VEMULA AVINASH	P	P	P	P	P	P	P	A	P	P	P	P	P	P	P	A	P	P	P	P
7	17E31A0468	VISLAVATH SHIVA	P	P	P	P	P	P	P	P	P	P	P	P	P	P	P	A	P	P	P	P
8	17E31A0207	CHIDUMULA APARNA	P	P	P	P	P	P	P	P	P	P	P	P	P	P	P	A	P	P	P	P
9	17E31A0214	KATAKAM GOPI	P	P	P	P	P	P	A	P	P	P	P	P	P	P	P	A	P	P	P	P
10	17E31A0225	SYED ZAFAR	P	P	P	P	P	P	P	A	P	P	P	P	P	P	P	A	P	P	P	P
11	17E31A0228	V SWATHI	P	P	P	P	P	P	P	P	P	P	P	P	P	P	P	A	P	P	P	P
12	17E31A1207	C PRASHANSHA	P	P	P	P	P	P	P	P	P	P	P	P	P	P	P	A	P	P	P	P
13	17E31A1239	SAMA NAVYA	P	P	P	P	P	P	P	P	P	P	P	P	P	P	P	A	P	P	P	P
14	17E31A0508	CHELLOJU ANUSHA	P	P	P	P	P	P	P	A	P	P	P	P	P	P	P	A	P	P	P	P
15	17E31A0518	JAMADANDA MANISH	P	P	P	P	P	P	P	A	P	P	P	P	P	P	P	A	P	P	P	P
16	17E31A0528	LONE HARISH	P	P	P	P	P	P	P	A	P	P	P	P	P	P	P	A	P	P	P	P
17	17E31A0548	THUKKANI SHREYA	P	P	P	P	P	P	P	A	P	P	P	P	P	P	P	A	P	P	P	P
18	17E31A0105	BHUKYA RAJU	P	P	P	P	P	P	P	P	P	P	P	P	P	P	P	A	P	P	P	P
19	17E31A0134	ESSAM KAVYA	P	P	P	P	P	P	P	P	P	P	P	P	P	P	P	A	P	P	P	P
20	17E31A0304	BANGARI MOHAN	P	P	P	P	P	P	P	A	P	P	P	P	P	P	P	A	P	P	P	P
21	17E31A0315	JARPLA SANDEEP	P	P	P	P	P	P	P	P	P	P	P	P	P	P	P	A	P	P	P	P
22	17E31A0324	MALLETHULA RAHUL	P	P	P	P	P	P	P	P	P	P	P	P	P	P	P	A	P	P	P	P
23	17E31A2108	G SRIKANTH	P	P	P	P	P	P	P	P	P	P	P	P	P	P	P	A	P	P	P	P
24	17E31A2136	KUDIKALA ANOSH	P	P	P	P	P	P	P	P	P	P	P	P	P	P	P	A	P	P	P	P
25	17E31A2127	SAMBARU VIKAS	P	P	P	P	P	P	P	P	P	P	P	P	P	P	P	A	P	P	P	P

M Ratibha

HOD
 Department of Humanities & Science
 Mahaveer Institute of Science & Technology
 HYDERABAD

**MAHAVEER INSTITUTE OF
SCIENCE AND TECHNOLOGY**
APPROVED BY AICTE AFFILIATED TO JNTUH - HYD.
DEPARTMENT OF
HUMANITIES AND SCIENCES



Certificate

This is to certify that Mr/Ms V Rahul _____
bearing Hall Ticket No 17E31A0465 of B.Tech First Year
has participated In Certificate course on **ULTRASONICS**
From 26-10-17 to 18-11-17 _ organized by Dept. of
Humanities and Sciences

M. Ratilika
NOD
Department of Humanities & Sciences
Mahaveer Institute of Science & Technology
HYDERABAD

K. Kalyan
PRINCIPAL,
MAHAVEER
INSTITUTE OF SCIENCE & TECHNOLOGY
HYDERABAD, HYD-500046,