



**DEPARTMENT OF CIVIL ENGINEERING**  
**2016-2017**

**PROJECT BATCH LIST**

**BATCH-1**

| S.No | H.T.No of students | Name of the students | Name of the Guide | Title of the project |
|------|--------------------|----------------------|-------------------|----------------------|
| 1    | 13E31A0103         | A. ARAVID            | R. BHEEMAL        | TOWN PLANNING        |
| 2    | 13E31A0122         | K. RAKESH            |                   |                      |
| 3    | 14E35A0102         | A. MAHESH            |                   |                      |
| 4    | 14E35A0104         | N. MOTHILAL          |                   |                      |
| 5    | 14E35A0105         | B. RAMESH            |                   |                      |

**BATCH -2**

|    |            |                  |                 |  |
|----|------------|------------------|-----------------|--|
| 6  | 13E31A0112 | C. RANJITH KUMAR | B. RAMANA KUMAR | DESIGN AND EXECUTION OF POST-TENSION SLABS |
| 7  | 13E31A0117 | G. SOMA SHEKAR   |                 |  |
| 8  | 13E31A0129 | M. RENUKA        |                 |  |
| 9  | 13E31A0145 | S. KAPIL KUMAR   |                 |  |
| 10 | 14E35A0101 | B. ESHWAR RAO    |                 |  |

**BATCH -3**

|    |            |              |                |  |
|----|------------|--------------|----------------|--|
| 11 | 13E31A0109 | B. SHARAN    | CH. NEEMALATHA | ANALYSI & DESIGN OF COMMUNICATION TOWER ON MULTI STOREY BUILDING USING STAAD PRO |
| 12 | 13E31A0120 | MD. FAIAZ    |                |  |
| 13 | 13E31A0124 | T. KAUSALYA  |                |  |
| 14 | 13E31A0147 | S. DIVYA     |                |  |
| 15 | 13E31A0150 | U. SAI KIRAN |                |  |

*(Signature)*

**PRINCIPAL**  
**MAHAVEER**  
INSTITUTE OF SCIENCE & TECHNOLOGY  
Bandlaguda, Hyd-500 005.



| BATCH-4 |            |                         |               |   |
|---------|------------|-------------------------|---------------|---|
| 16      | 13E31A0119 | IRFAN AHMED<br>KAAM     | B VARALAXMI   | EFFECT OF SHEAR<br>WALL ON PALL<br>BUILDINGS  |
| 17      | 13E31A0127 | MD MASROOR<br>ALAM      |               |   |
| 18      | 13E31A0133 | MOHAMMED ILYAS<br>UDDIN |               |   |
| 19      | 13E31A0134 | MOHAMMED<br>MOUZZAM     |               |   |
| 20      | 13E31A0146 | SHIV SHANKAR<br>SINGH   |               |   |
| BATCH-5 |            |                         |               |   |
| 21      | 13E31A0106 | A VIJAYA                | M SRUJAN TEJA | DESIGN AND<br>ANALYSIS OF MULTI<br>STOREY RESIDENTIAL<br>BUILDING(G + 5)<br>USING ETABS |
| 22      | 13E31A0111 | CH. KARNAKAR            |               |   |
| 23      | 13E31A0118 | G RAGHAVENDAR           |               |   |
| 24      | 13E31A0126 | M VIJAY                 |               |   |
| BATCH-6 |            |                         |               |   |
| 25      | 13E31A0137 | M VISHVA TEJA           | CH SWETHAMBER | A PROJECT REPORT<br>ON RURAL WATER<br>SUPPLY  |
| 26      | 13E31A0139 | H RAJESH KUMAR          |               |   |
| 27      | 13E31A0140 | P KRISHITA              |               |   |
| 28      | 13E31A0152 | V SUSHRUTHA             |               |   |
| 29      | 13E31A0123 | K RAJESH                |               |   |

*K. Srinivas*  
PRINCIPAL  
**MAHAVEER**  
INSTITUTE OF SCIENCE & TECHNOLOGY  
Bandlaguda, Hyd-500 005.



| BATCH-7 |            |                           |               |  |
|---------|------------|---------------------------|---------------|--|
| 30      | 13E31A0128 | M VINOD REDDY             | K SAI PRADEEP | DESIGN AND ANALYSIS OF RESIDENTIAL BUILDING(G+S)                             |
| 31      | 13E31A0131 | M NAVEEN KUMAR            |               |  |
| 32      | 13E31A0141 | P PRAKASH                 |               |  |
| 33      | 13E31A0144 | S SHIVA KUMAR             |               |  |
| 34      | 13E31A0151 | V SRINIVAS                |               |  |
| BATCH-8 |            |                           |               |  |
| 35      | 14E35A0103 | MD IMITHIYAZ HUSSAIN      | M SARITHA     | STUDY OF MATERIALS AND CONSTRUCTION TECHNIQUES USED IN TRADITIONAL BUILDINGS |
| BATCH-9 |            |                           |               |  |
| 36      | 13E31A0132 | MIRZA MOHAMMED ALI BAIG   | M SRUJAN TEJA | DESIGN OF PRE FABRICATED BUILDING BY USING STAAD PRO V8I                     |
| 37      | 13E31A0136 | MOHAMMED SAROJ AHMED      |               |  |
| 38      | 13E31A0143 | SK SHAFIAWAZ              |               |  |
| 39      | 13E31A0148 | AHMED MANBOOB ALI BUKHARI |               |  |

*Principal*  
**PRINCIPAL**  
**MAHAVEER**  
INSTITUTE OF SCIENCE & TECHNOLOGY  
Bandlaguda, Hyd-500 005



| BATCH-10 |            |                  |                    |   |
|----------|------------|------------------|--------------------|---|
| 40       | 13E31A0104 | A SANATH KUMAR   | DR K S S S N REDDY | DESIGN AND ESTIMATION OF PALLE CHERUVU ROAD |
| 41       | 13E31A0107 | B SRIVANI        |                    |   |
| 42       | 13E31A0110 | CH KAVYA SREE    |                    |   |
| 43       | 13E31A0121 | K VAMSHI KRISHNA |                    |   |
| 44       | 13E31A0130 | M SUSHANTH ENOCH |                    |   |
| BATCH-11 |            |                  |                    |   |
| 45       | 13E31A0101 | A AAKASH GOUD    | N DIVYA            | PLANNING OF GATED COMMUNITY                 |
| 46       | 13E31A0114 | D DEEKSHA        |                    |   |
| 47       | 13E31A0115 | G MAHESH         |                    |   |
|          | 13E31A0116 | G SANDEEP        |                    |   |
| 48       | 13E31A0142 | R VINOD KUMAR    |                    |   |

HOD

PRINCIPAL  
**MAHAVEER**  
INSTITUTE OF SCIENCE & TECHNOLOGY  
Bandlaguda, Hyd-500 005.



MAHAVEER INSTITUTE OF SCIENCE AND TECHNOLOGY

BANDLAGUDA, HYDERBAD-500 005

2016-2017

DEPARTMENT OF CIVIL ENGINEERING



ESTD : 2001

### CERTIFICATE

This is to certify that the major project entitled "TOWN PLANNING" submitted by

|            |   |            |
|------------|---|------------|
| A.ARAVIND  | - | 13E31A0103 |
| K.RAKESH   | - | 13E31A0122 |
| A.MAHESH   | - | 14E35A0102 |
| N.MOTHILAL | - | 14E35A0104 |
| B.RAMESH   | - | 14E35A0105 |

in partial fulfillment of the requirements for the award of the Degree of Bachelor of Technology in civil Engineering. To the Jawaharlal Nehru Technological University as a record of bonafide work done by him under our supervision and guidance.

Internal Guide

R.HIREMLAL

(Asst.Prof)

External Guide

Head of the department

CILSWETHAMBER

Principal

PRINCIPAL  
MAHAVEER  
INSTITUTE OF SCIENCE & TECHNOLOGY  
Bandlaguda, Hyd-500 005.

**MAHAVEER INSTITUTE OF SCIENCE & TECHNOLOGY**  
(Affiliated to JNTU-Hyderabad, approved by AICTE)  
Vyasapuri (Post), Bandlaguda, Keshavagiri, Hyderabad-500005

Department Of Civil Engineering



ESTD : 2001

### CERTIFICATE

This is to certify that the project report entitled "DESIGN AND EXECUTION OF POST-TENSION SLABS" is being submitted by C.RANJITHKUMAR, G.SOMASHEKAR REDDY, M.RENUKA, S.KAPIL KUMAR, BESHVAR RAO bearing Hall ticket number 13E31A0112, 13E31A0117, 13E31A0129, 13E31A0145, 14E35A0101 in partial fulfillment of the requirements for the award of the Degree of Bachelor of Technology in civil Engineering. To the Jawaharlal Nehru Technological University as a record of bonafide work done by him under our supervision and guidance.

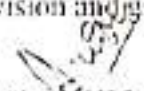
  
BRAMANA KUMAR  
INTERNAL GUIDE

  
EXTERNAL EXAMINER

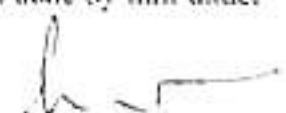
  
CH. SWETHAMBER  
HEAD OF DEPARTMENT

PRINCIPAL

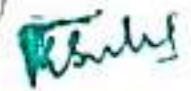

  
PRINCIPAL  
**MAHAVEER**  
INSTITUTE OF SCIENCE & TECHNOLOGY  
Bandlaguda, Hyd-500 005.

MAHAVEER INSTITUTE OF SCIENCE & TECHNOLOGY

BANDLAGUDA, HYDERABAD-500 005

2013-2017

Department Of Civil Engineering



ESTD : 2001

CERTIFICATE

This to certify that major project report titled "ANALYSIS & DESIGN OF COMMUNICATION TOWER ON MULTI STOREY BUILDING USING STAAD PRO" is being submitted by B.SHARAN (13E31A0109), MD FAIYAZ (13E31A0120), T.KAUSALYA(13E31A0124), S.DIVYA(13E31A0147), U.SAI KIRAN(13E31A0150) in partial fulfillment of the requirements for the award of degree of bachelor of technology in civil engineering. To the Jawaharlal Nehru Technological University as a record of bonafide work done by him/her under our supervision and guidance

*Ch. Hemalatha*

Internal Guide

**CH HEMALATHA**

Asst.Prof.

*[Signature]*

External

*[Signature]*

Head of Department

**CILSWPTILAMBER**

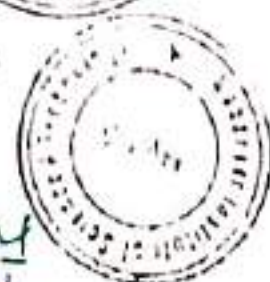

*[Signature]*

**PRINCIPAL  
MAHAVEER**

**INSTITUTE OF SCIENCE & TECHNOLOGY**  
Bandlaguda, Hyd-500 005.

**MAHAVEER INSTITUTE OF SCIENCE & TECHNOLOGY**

Vyasapuri(Post), Bandlaguda, Hyderabad 500005

(Affiliated to JNTU Hyderabad)

Department Of  
Civil Engineering



ESTD : 2001

**CERTIFICATE**

This is to certify that the project work entitle "EFFECT OF SHEAR WALL IN TALL BUILDINGS", is a bonafide work of by IRFAN AHMED KHAN (13E31A0119), MD MASROOR ALAM(13E31A0127), MOHAMMED ILYAS UDDIN(13E31A0133), MOHAMMED MOUAZZAM (13E31A0134), SHIV SHANKER SINGH(13E31A0146) bearing for the award of BACHELOR OF TECHNOLOGY in Civil Engineering during year 2016-2017.

This is further certified that the work done under my guidance, and the result of this work have not been submitted elsewhere for the award of any other degree.

INTERNAL GUIDE

B.VARALAXMI

EXTERNAL EXAMINER

HEAD OF THE DEPARTMENT

CILSWETHAMBER

PRINCIPAL

PRINCIPAL  
**MAHAVEER**  
INSTITUTE OF SCIENCE & TECHNOLOGY  
Bandlaguda, Hyd-500





# MAHAVEER INSTITUTE OF SCIENCE AND TECHNOLOGY

Approved by AICTE, affiliated to JNTU-Hyderabad,

Vyasapuri, Bandlaguda, Post Keshavgi, Hyderabad-500005

Department Of Civil Engineering



ESTD : 2001

## CERTIFICATE

This is to certify that the MAJOR PROJECT "DESIGN AND ANALYSIS OF MULTI STOREY RESIDENTIAL BUILDING (G+5) USING ETABS" submitted by A.VIJAYA, CH.KARNAKAR, G.RAGHAVENDHAR, M.VIJAY bearing Hall ticket number 13E31A0106, 13E31A0111, 13E31A0118, 13E31A0126 in partial fulfillment of the requirements for the award of the Degree of Bachelor of Technology in civil Engineering. To the Jawaharlal Nehru Technological University as a record of bonafide work done by him under our supervision and guidance.

  
INTERNAL GUIDE  
MSRUJAN TEJA

Assistant professor

  
EXTERNAL EXAMINAR



  
PRINCIPAL  
MAHAVEER  
INSTITUTE OF SCIENCE & TECHNOLOGY  
Bandlaguda, Hyd-500 005

# MAHAVEER INSTITUTE OF SCIENCE AND TECHNOLOGY

Approved by AICTE, affiliated to JNTU-Hyderabad,

Vyasapuri, Bandlaguda, POST Keshavagiri(P.O), Hyderabad-500005

Department Of Civil Engineering



ESTD : 2001

## CERTIFICATE

This is to certify that the MAJOR PROJECT "RURAL WATER SUPPLY" submitted by M.VISHWA TEJA, N.NAGESH KUMAR, P.KRISHNA, V.SUSMITHA bearing Hall ticket number 13E31A0137, 13E31A0139, 13E31A140, 13E31A0152 in partial fulfillment of the requirements for the award of the Degree of Bachelor of Technology in civil Engineering. To the Jawaharlal Nehru Technological University as a record of bonafide work done by him under our supervision and guidance.

  
INTERNAL GUIDE

CILSWETHAMBER

Assistant professor

  
EXTERNAL EXAMINER

  
HEAD OF DEPARTMENT

CILSWETHAMBER

PRINCIPAL





PRINCIPAL

**MAHAVEER**

INSTITUTE OF SCIENCE & TECHNOLOGY

Bandlaguda, Hyd-500 005

MAHAVEER INSTITUTE OF SCIENCE AND TECHNOLOGY

BANDLAGUDA, HYDERBAD-500 005

2013-2017

DEPARTMENT OF CIVIL ENGINEERING



ESTD: 2001

### CERTIFICATE

This is to certify that the major project entitled "DESIGN AND ANALYSIS OF RESIDENTIAL BUILDING (G+5)" submitted by M.VINOD REDDY-13E31A0128; M.NAVEEN KUMAR- 13E31A0131; P. PRAKASH - 13E31A0141; S. SHIVA KUMAR - 13E31A0144; V. SRINIVAS-13E31A0151 in partial fulfilment of the requirements for the award of the Degree of Bachelor of Technology in civil Engineering To the Jawaharlal Nehru Technological University as a record of bonafide ~~work~~ <sup>work done</sup> by him under our supervision and guidance.

 18/4/17  
Internal Guide

K.SAI PRADEEP

Asst Prof

  
External examiner



Head of the department

CH.SWETHAMBER

Principal

PRINCIPAL  
MAHAVEER  
INSTITUTE OF SCIENCE & TECHNOLOGY  
Bandlaguda, Hyd-500 005.



PRINCIPAL  
MAHAVEER  
INSTITUTE OF SCIENCE & TECHNOLOGY  
Bandlaguda, Hyd-500 005.

# MAHAVEER INSTITUTE OF SCIENCE & TECHNOLOGY

Department of Civil Engineering



ESTD : 2001

## CERTIFICATE

This is to certify that the project report titled "STUDY OF MATERIALS AND CONSTRUCTION TECHNIQUES USED IN TRADITIONAL AND HISTORICAL BUILDINGS - A CASE OF MUKTHYALA PALACE" is being submitted by MD. IMTHIAZ HUSSAIN, bearing hall ticket no. 14E35A0103, in partial fulfillment BACHELOR OF TECHNOLOGY (IV-II) in CIVIL ENGINEERING is a record befitting work carried out by them. The results embodied in this report have not been submitted to any other University for the award of any degree.

Internal Guide

Head of Department



External Examiner

**PRINCIPAL**  
**MAHAVEER**  
INSTITUTE OF SCIENCE & TECHNOLOGY  
Banjara Hills, Hyd-500 005.



MAHAVEER INSTITUTE OF SCIENCE & TECHNOLOGY  
(Affiliated to JNTU Hyderabad, Approved by AICTE)  
Vyasapuri Panchayath, Bandlaguda Mandal, Hyderabad-500 005  
DEPARTMENT OF CIVIL ENGINEERING



ESTD : 2001

CERTIFICATE

This is to certify that the major project titled "DESIGN OF PREFABRICATED BUILDING BY USING STAAD PRO V8i" is being submitted by MIRZA MOHAMMED ALI BAIG, MOHD SHAROF AHMED, S K SHANAWAZ, SYED AHMED MEHBOOB ALI BUKHARI bearing Hall ticket numbers (13E31A0132, 13E31A0136, 13E31A0143, 13E31A0148), in partial fulfillment for the award of Degree of Bachelor of Technology in Civil Engineering. Mahaveer Institute of Science and Technology to JNTU, is a record of bonafide work carried out by them. The results embodied in this report have not been submitted in any other university for award of any degree.

  
19/11/17  
M. SRUJAN TEJA  
INTERNAL GUIDE

  
EXTERNAL EXAMINER



PRINCIPAL

  
PRINCIPAL  
MAHAVEER  
INSTITUTE OF SCIENCE & TECHNOLOGY  
Bandlaguda, Hyd-500 005.

MAHAVEER INSTITUTE OF SCIENCE AND TECHNOLOGY

BANDLAGUDA, HYDERBAD-500005

APRIL 2017

DEPARTMENT OF CIVIL ENGINEERING



ESTD : 2001

### CERTIFICATE

This is to certify that the major project entitled "DESIGN AND ESTIMATION OF PALLECHERUVU ROAD" submitted by

|                  |   |            |
|------------------|---|------------|
| A.SANATH KUMAR   | - | 13E31A0104 |
| B. SRIVANI       | - | 13E31A0107 |
| CH. KAVYASREE    | - | 13E31A0110 |
| K. VAMSIKRISHNA  | - | 13E31A0121 |
| M. SUSHANTHENOCH | - | 13E31A0130 |

in partial fulfillment of the requirements for the award of the Degree of Bachelor of Technology in civil Engineering. To the Jawaharlal Nehru Technological University as a record of bonafide work done by him under our supervision and guidance.

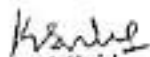
  
Internal Guide

DR.K.S.S.N.REDDY

Professor

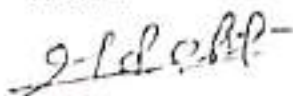
  
External examiner

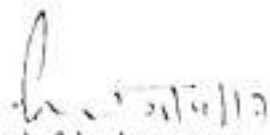
  
Head of the department

CH.SWETHAMBER

  
PRINCIPAL  
MAHAVEER  
INSTITUTE OF SCIENCE & TECHNOLOGY  
Bandlaguda, Hyd-500 005.

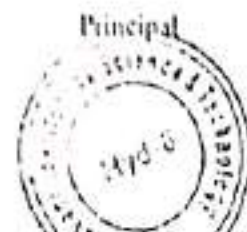

MAHAVEER INSTITUTE OF SCIENCE AND TECHNOLOGY

BANDLAGUDA, HYDERBAD-500 005

2013-2017

DEPARTMENT OF CIVIL ENGINEERING



ESTD : 2001

### CERTIFICATE

This is to certify that the major project entitled "PLANINGG OF GATED COMMUNITY" submitted by

|               |   |            |
|---------------|---|------------|
| A.AKASH GOUD  | - | 13E31A0101 |
| D.DEEKSHA     | - | 13E31A0114 |
| G.MAHESH      | - | 13E31A0115 |
| G.SANDEEP     | - | 13E31A0116 |
| R.VINOD KUMAR | - | 13E31A0142 |

In partial fulfilment of therequirements for the award of the Degree of Bachelor of Technology in civil Engineering. To the Jawaharlal Nehru Technological University as a record of bonafide work done by him under our supervision and guidance.

  
Internal Guide

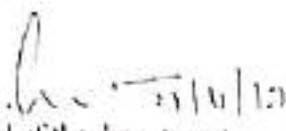
  
Head of the department

N.DIVYA  
(Asst. Professor)

CH.SWETHAMBER

  
External examiner

  
PRINCIPAL  
MAHAVEER  
INSTITUTE OF SCIENCE & TECHNOLOGY  
Bandlaguda, Hyd-500 005.



# MAHAVEER INSTITUTE OF SCIENCE AND TECHNOLOGY

## EEE-Main Project Batches-2016-17

| S.no. | Roll No's  | Name                  | GUIDE           | TITLE OF THE PROJECT   |
|-------|------------|-----------------------|-----------------|--|
| 1     | 13E31A0202 | AITHA VIJAY           | K.SURESH KUMAR  | An intelligent system for monitoring and controlling of street light using GSM Technology  |
|       | 13E31A0219 | K.LAXMAN REDDY        |                 |  |
|       | 13E31A0234 | PUPPALA MAHESH        |                 |  |
|       | 13E31A0214 | EJJAGIRI SRIKAR       |                 |  |
| 2     | 13E31A0233 | P.VIGNESWARA REDDY    | S.SURESH        | GSM based Motor control using starter  |
|       | 13E31A0218 | P.KUMAR               |                 |  |
|       | 13E31A0207 | B. SURESH BABU        |                 |  |
|       | 138P1A0202 | P SHYAM SUNDER LAXMAN |                 |  |
| 3     | 13E31A0203 | AJMEERA RAVI RAM      | Dr.R.V.AMARNATH | Detecting Power Grid Synchronization failure on sensing frequency and voltage beyond acceptable range and Phase Sequence Checker |
|       | 13E31A0208 | BODDU NIHARIKA        |                 |  |
|       | 13E31A0232 | PALADUGU NAVYA        |                 |  |
|       | 14E35A0210 | P VINEETHA            |                 |  |
| 4     | 13E31A0201 | A HARISH              | P.PHANINDRA     | Design ,Fabrication and Testing of Single Phase Prepaid energy meter.  |
|       | 13E31A0209 | CH. SREENATH REDDY    |                 |  |
|       | 13E31A0220 | KETHAVATH SRINATH     |                 |  |
|       | 13E31A0222 | L RAJESH NAIK         |                 |  |
|       | 12E31A0237 | RANJEETH              |                 |  |
| 5     | 13E31A0206 | B. RAMA PRATHYUSHA    | S.PRAVEEN KUMAR | Ultra Fast Acting Electronic Circuit Breaker   |
|       | 13E31A0210 | CHOWDI SACHIN         |                 |  |
|       | 13E31A0231 | PADIGELA BHAVANA      |                 |  |
| 6     | 13E31A0213 | DHANAVATH ANIL        | Dr.R.V.AMARNATH | Automatic Dual Axis Solar Tracking system and Solar Energy to Thermal Refrigeration without Compressor                           |
|       | 13E31A0221 | KOLLI MANOGNA         |                 |  |
|       | 13E31A0236 | SHAIK DADA RASHEED    |                 |  |
|       | 138P1A0203 | RAAYIKOTI SHRAVANI    |                 |  |
|       |            | ANUSHA                |                 |  |

K. Suresh

PRINCIPAL  
**MAHAVEER**  
 INSTITUTE OF SCIENCE & TECHNOLOGY  
 Bandlaguda, Hyd-500 005



**MAHAVEER INSTITUTE OF SCIENCE AND TECHNOLOGY**

**EEE-Main Project Batches-2016-17**

|                     |            |                    |                   |   |
|---------------------|------------|--------------------|-------------------|---|
| 13                  | 14E35A0201 | HALVATH VUJAYKUMAR | A.MAHESH KUMAR    | Soil moisture content based automatic motor stater for Irrigation |
|                     | 14E35A0207 | BADAVATH NAVEEN    |                   |   |
|                     | 14E35A0213 | VARTHIA AKHIL      |                   |   |
| Project co-ordinate |            |                    | HOD EEE           |   |
| N.Saraswathi        |            |                    | Dr. R.V. Amarnath |   |

*R.V. Amarnath*

PRINCIPAL  
MAHAVEER  
INSTITUTE OF SCIENCE & TECHNOLOGY  
Bandlaguda, Hyd-500 005.

# MAHAVEER INSTITUTE OF SCIENCE AND TECHNOLOGY

(Approved by AICTE, Affiliated to JNTU, Hyderabad)  
Vyasapuri, Bandlaguda, Post: Keshavagiri, Hyderabad - 500005.



ESTD : 2001

## CERTIFICATE

This is to certify that the Dissertation entitled "DETECTING POWER GRID SYNCHRONIZATION FAILURE ON SENSING FREQUENCY & VOLTAGE BEYOND ACCEPTABLE RANGE & INCOMING SUPPLY BREAK," is carried out by A.RAVIRAM (13E31A0203), B.NIHARIKA (13E31A0208), P.NAVYA(13E31A0232) and P.VINEETHA(14E35A0210) in partial fulfillment of the academic requirements for the award of the degree of BACHELOR OF TECHNOLOGY in Electrical and Electronics Engineering, MAHAVEER INSTITUTE OF SCIENCE AND TECHNOLOGY, Hyderabad during the academic year 2013-2017.

*R.V. Amarnath*  
INTERNAL GUIDE

Dr.R.V.AMARNATH,  
Professor & Head (EEE) Dept

*K. Srinivas*

PRINCIPAL  
MAHAVEER INSTITUTE OF SCIENCE & TECHNOLOGY  
BANDLAGUDA, HYDRABAD

*R.V. Amarnath*  
HEAD OF THE DEPARTMENT

Dr.R.V.AMARNATH  
Professor & Head (EEE) Dept

*Chandana*  
EXTERNAL EXAMINER

Scanned by TapScanner

Department of Electrical and Electronics Engineering

**MAHAVEER INSTITUTE OF SCIENCE AND TECHNOLOGY**

[Affiliated to JNTU Hyderabad, Approved by AICTE]

Vyasapuri, Bandlaguda, Post: Keshavgiri, Hyderabad-500005

APRIL 2017



**CERTIFICATE**

This is to certify that the project entitled "**HANDMADE HOVERBOARD WITH**

**VACUUM CLEANER**" is the work done by

- 1) M A MOID FAHAD [13E31A0223]
- 2) MOHD AMAN ULLAH YASEEN [13E31A0227]
- 3) MOHAMMED FAIZAN [138P1A0201]
- 4) SYED ABUBAKKAR ADNAN [138P1A0204]

In partial fulfillment for the requirement for degree of **Bachelor of Technology** in Electrical and Electronics Engineering by **Jawaharlal Nehru Technological University, Hyderabad.**

The contents of this report have not been submitted to any University / Institute for the award of any other Degree / Diploma.

  
Internal guide

**G.PREM KUMAR REDDY**

Associate professor of

Electrical and Electronics Engineering

MIST, HYDERABAD

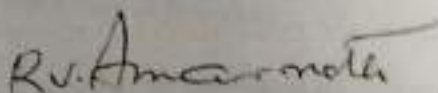

Dr. R.V Amarnath

Head of the Dept. of

Electrical and Electronics Engineering

MIST, HYDERABAD

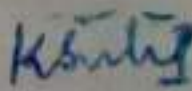
  
PRINCIPAL  
**MAHAVEER**  
INSTITUTE OF SCIENCE & TECHNOLOGY  
Bandlaguda, Hyd-500 005.



Department of Electrical and Electronics Engineering  
**MAHAVEER INSTITUTE OF SCIENCE AND TECHNOLOGY**

(Affiliated to INTU Hyderabad, Approved by AICTE)

Vyasapuri, Bandlaguda, Post: Keshavgiri, Hyderabad-500005

(2016-17)



ESTD:2001

**CERTIFICATE**

This is to certify that the project entitled "DESIGN & IMPLEMENTATION OF FOUR QUADRANT DC DRIVE USING CHOPPER" is the work done by

|               |              |
|---------------|--------------|
| B.VINAY KUMAR | (13E31A0205) |
| CH.VAMSHI     | (13E31A0211) |
| D.VENKATESH   | (13E31A0212) |
| S.MALLIKARJUN | (13E31A0235) |

In partial fulfillment for the requirements for the award of the degree of Bachelor of Technology in Electrical and Electronics Engineering by Jawaharlal Nehru Technological University, Hyderabad.

The contents of this report have not been submitted to any University / Institute for the award of any other Degree.

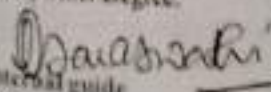
  
Internal guide  
N.Saraswathi (M.Tech)  
Asst. professor  
Dept. of EEE  
MIST, HYDERABAD

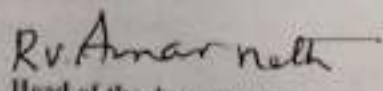
  
Head of the department  
Dr.R.V. Amarnath (M.Tech., Ph.D)  
Professor & Head  
Dept. of EEE  
MIST, HYDERABAD

  
External Examiner

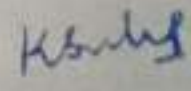
  
PRINCIPAL  
MAHAVEER  
INSTITUTE OF SCIENCE & TECHNOLOGY  
Bandlaguda, Hyd-500 005.



Department of Electrical and Electronics Engineering  
**MAHAVEER INSTITUTE OF SCIENCE AND  
TECHNOLOGY**

(Affiliated to JNTU Hyderabad, Approved by AICTE)

Vyasapuri, Bandlaguda, Post: Keshavgi, Hyderabad-500005

APRIL 2017



CERTIFICATE

This is to certify that the project entitled " **ULTRA FAST ACTING  
ELECTRONIC CIRCUIT BREAKER** " is the work done by

|                   |              |
|-------------------|--------------|
| B.RAMA PRATHYUSHA | (13E31A0206) |
| C.SACHIN          | (13E31A0210) |
| P.BHAVANA         | (13E31A0231) |

In partial fulfillment for the requirements for degree of **Bachelor of  
Technology** in Electrical and Electronics Engineering by **Jawaharlal  
Nehru Technological University, Hyderabad.**

The contents of this report have not been submitted to any University  
/ Institute for the award of any other Degree / Diploma.

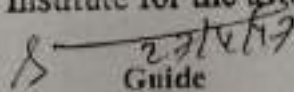
  
Guide

**S Praveen kumar**  
(Asst.prof)

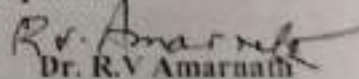
  
Dr. R.V Amaruath

Prof. and Head of the Dept. of  
Electrical and Electronics Engineering  
**MIST, HYDERABAD**

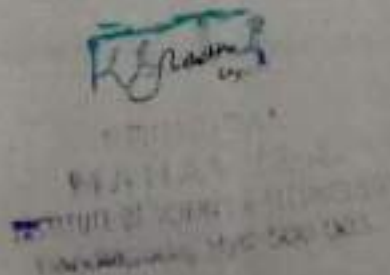

Department of Electrical and Electronics Engineering  
**MAHAVEER INSTITUTE OF SCIENCE AND TECHNOLOGY**

(Affiliated to JNTU Hyderabad, Approved by AICTE)  
Vyasapuri, Bandlaguda, Post: Keshavgiri, Hyderabad-500005  
(2016-17)



ESTD:2001

**CERTIFICATE**

This is to certify that the project entitled "DESIGN & IMPLEMENTATION OF FOUR QUADRANT DC DRIVE USING CHOPPER" is the work done by

|                      |              |
|----------------------|--------------|
| <b>B.VINAY KUMAR</b> | (13E31A0205) |
| <b>CH.VAMSHI</b>     | (13E31A0211) |
| <b>D.VENKATESH</b>   | (13E31A0212) |
| <b>S.MALLIKARJUN</b> | (13E31A0235) |

In partial fulfillment for the requirements for the award of the degree of Bachelor of Technology in Electrical and Electronics Engineering by Jawaharlal Nehru Technological University, Hyderabad.

The contents of this report have not been submitted to any University / Institute for the award of any other Degree.

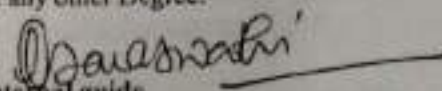
  
Internal guide  
**N.Saraswathi (M.Tech)**  
Asst.professor  
Dept. of EEE  
MIST, HYDERABAD

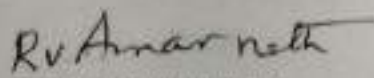
  
Head of the department  
**Dr.R.V. Amarnath (M.Tech, Ph.D)**  
Professor & Head  
Dept. of EEE  
MIST, HYDERABAD

  
External Examiner

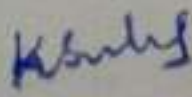
  
PRINCIPAL  
**MAHAVEER**  
INSTITUTE OF SCIENCE & TECHNOLOGY  
Bandlaguda, Hyd-500 005.

Department of Electrical and Electronics Engineering  
**MAHAVEER INSTITUTE OF SCIENCE AND TECHNOLOGY**

(Affiliated to JNTU Hyderabad, Approved by AICTE)

Vyasapuri, Bandlaguda, post: Keshavnagar Hyderabad-500005

(2016-17)



ESTD : 2001

CERTIFICATE

This is to certify that the project entitled "BLDC motor speed control by using space vector pulse width modulation" is the work done by

|                 |              |
|-----------------|--------------|
| S.MANOJ KUMAR   | (13E31A0237) |
| S.SAI KUMAR     | (13E31A0238) |
| Y.HAREESH       | (13E31A0239) |
| P.PRAVEEN KUMAR | (13E31A0240) |

In partial fulfilment of the requirement of the degree of bachelor of technology in electrical and electronics engineering by Jawaharlal Nehru technological university, Hyderabad.

The contents of this report have not been submitted by any university/ institute for the award of any other degree

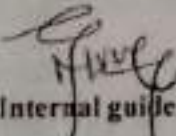
  
Internal guide

G. Prem kumar reddy

Asso. professor

Dept. of E.E.E

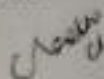

EXTERNAL EXAMINER



Head,

Department of E.E.E

Dr. R.V. Amarnath

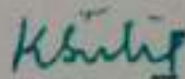

PRINCIPAL  
**MAHAVEER**  
INSTITUTE OF SCIENCE & TECHNOLOGY  
Bandlaguda, Hyd-500 005.



MAHAVEER INSTITUTE OF SCIENCE AND TECHNOLOGY

DEPARTMENT OF  
ELECTRICAL & ELECTRONICS ENGINEERING

(Approved by AICTE, affiliated to JNTU-Hyderabad.) Vyasपुरi,  
Bandlaguda, POST Keshavgi (p.o), Hyderabad-500005

2014 - 2018



ESTD : 2001  
CERTIFICATE

This is to certify the project report title "ZIGBEE BASED ENERGY SAVING SYSTEMS IN SCHOOLS AND HOTELS" is the work done  
by

|               |            |
|---------------|------------|
| G.RAKESH      | 13E31A0215 |
| G.MAHESH      | 15E35A0205 |
| K.SAI KRISHNA | 15E35A0207 |
| TANVEER KHAN  | 15E35A0208 |

In partial fulfillment of the requirement of the award of degree of  
BACHELOR OF TECHNOLOGY  
in  
ELECTRICAL & ELECTRONICS ENGINEERING,

  
INTERNAL GUIDE

Mr. B. SATHISH<sup>M.Tech</sup>  
(Asst prof, EEE Dept)

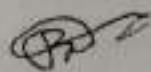

  
HEAD OF THE DEPARTMENT

Dr. R.V. AMARNATH<sup>Ph.D</sup>  
(Prof & HOD, EEE)

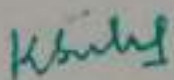
  
PRINCIPAL  
MAHAVEER

INSTITUTE OF SCIENCE & TECHNOLOGY  
Bandlaguda, Hyd-500 605.



Department of Electrical and Electronics Engineering  
**MAHAVEER INSTITUTE OF SCIENCE AND  
TECHNOLOGY**

(Affiliated to JNTU Hyderabad, Approved by AICTE)  
Vyasapuri, Bandlaguda, Post: Keshavgi, Hyderabad-500005  
APRIL 2017



CERTIFICATE

This is to certify that the project entitled "**RENEWABLE WIND  
ENERGY GENERATION FROM WIND FLOW USING  
VK0001 PANEL**" is the work done by

KANAGALA ANURAG (13E31A0217)  
MEDA SUVARNA (13E31A0225)  
MOHAMMAD IBRAHIM (13E31A0226)  
NADIKUDA SAMATHA (13E31A0229)

In partial fulfillment for the requirements for degree of Bachelor of Technology in Electrical and  
Electronics Engineering by Jawaharlal Nehru Technological University, Hyderabad.

The contents of this report have not been submitted to any University / Institute for the  
award of any other Degree / Diploma.

*R. Kalyani*  
Internal guide  
R. KALYANI

(Asst. Prof)  
MIST, HYDERABAD

*Kalyani*  
PRINCIPAL  
MAHAVEER  
INSTITUTE OF SCIENCE & TECHNOLOGY  
Bandlaguda, Hyd-500 005.

*R.V. Amarantii*  
Dr.R.V.AMARANTII  
Head of the Dept.

EEE  
MIST, HYDERABAD

Department of Electrical and Electronics Engineering  
**MAHAVEER INSTITUTE OF SCIENCE AND  
TECHNOLOGY**

(Affiliated to JNTU Hyderabad, Approved by AICTE)

Vyasapuri, Bandlaguda, Post: Keshavgi, Hyderabad-500005

APRIL 2017



CERTIFICATE

This is to certify that the project entitled **"RENEWABLE WIND  
ENERGY GENERATION FROM WIND FLOW USING  
VK0001 PANEL"** is the work done by

KANAGALA ANURAG (13E31A0217)

MEDA SUVARNA (13E31A0225)

MOHAMMAD IBRAHIM (13E31A0226)

NADIKUDA SAMATHA (13E31A0229)

In partial fulfillment for the requirements for degree of Bachelor of Technology in Electrical and Electronics Engineering by Jawaharlal Nehru Technological University, Hyderabad.

The contents of this report have not been submitted to any University / Institute for the award of any other Degree / Diploma.

*R. Kalyani*  
Internal Guide  
R. KALYANI

(Asst. Prof)

MIST, HYDERABAD

*Kalyani*  
PRINCIPAL  
MAHAVEER  
INSTITUTE OF SCIENCE & TECHNOLOGY  
Bandlaguda, Hyd-500 005

*R.V. Amarant*  
Dr. R.V. AMARANTH  
Head of the Dept.

EEE

MIST, HYDERABAD

Department of Electrical and Electronics Engineering  
**MAHAVEER INSTITUTE OF SCIENCE AND TECHNOLOGY**

(Affiliated to JNTU Hyderabad, Approved by AICTE)  
Vyasapuri, Bandlaguda, Post: Keshavgi, Hyderabad-500005  
(2016-17)



ESTD:2001

**CERTIFICATE**

This is to certify that the project entitled "DESING & IMPLEMENTATION OF FOUR QUADRANT DC DRIVE USING CHOPPER" is the work done by

|               |              |
|---------------|--------------|
| B.VINAY KUMAR | (13E31A0205) |
| CH.VAMSHI     | (13E31A0211) |
| D.VENKATESH   | (13E31A0212) |
| S.MALLIKARJUN | (13E31A0235) |

In partial fulfillment for the requirements for the award of the degree of Bachelor of Technology in Electrical and Electronics Engineering by Jawaharlal Nehru Technological University, Hyderabad.

The contents of this report have not been submitted to any University / Institute for the award of any other Degree.

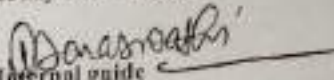
  
Internal guide  
N.Saraswathi (M.Tech)  
Asst.professor  
Dept. of EEE  
MIST, HYDERABAD

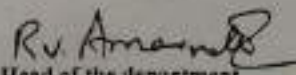
  
Head of the department  
Dr.R.V. Amarnath (M.Tech, Ph.D)  
Professor & Head  
Dept. of EEE  
MIST, HYDERABAD

External Examiner

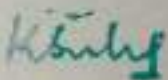
  
PRINCIPAL  
MAHAVEER  
INSTITUTE OF SCIENCE & TECHNOLOGY  
Bandlaguda, Hyd-500 005.





## DEPARTMENT OF MECHANICAL ENGINEERING

### MAIN PROJECT LIST-2016-2017

| BATCH NO | H.T. NO    | STUDENT NAME      | TITLE OF THE PROJECT                                      | NAME OF THE GUIDE |
|----------|------------|-------------------|---|-------------------|
| 1        | 13E31A0331 | K. BHAVANI SANKAR | MODELLING AND FABRICATION OF AUTOMATED SOLAR GRASS CUTTER | GANESHAN,K        |
|          | 13E31A0302 | A. MAHESH         |   |                   |
|          | 13E31A0356 | S. SRINIVAS       |   |                   |
|          | 13E31A0322 | MADHAV            |   |                   |
|          | 13E31A0358 | T. KRISHNA RAO    |   |                   |
| 2        | 13E31A0317 | B.SAI MANOJ KUMAR | FABRICATION OF MULTISPINDLE DRILLING MACHINE              | B. HARINATH REDDY |
|          | 13E31A0359 | T. ANIL           |   |                   |
|          | 13E31A0330 | K. PAVAN KUMAR    |   |                   |
|          | 13E31A0307 | A. JASHWANTH      |   |                   |
|          | 13E31A0327 | J. NAVEEN         |   |                   |
| 3        | 13E31A0348 | R. VAMSHIDHER     | FABRICATION OF 3- AXIS CNC DRILLING MACHINE               | S. SUDHAKARA      |
|          | 13E31A0347 | R. KAMAL          |   |                   |
|          | 13E31A0351 | S. MUKESH         |   |                   |
|          | 13E31A0342 | M. SHAKER         |   |                   |
|          | 13E31A0323 | B. AKASH          |   |                   |



|   |            |                       |   |                       |
|---|------------|-----------------------|---|-----------------------|
| 4 | 13E31A0341 | M. ABHINAV            | FABRICATION OF BIOMECHANICAL ENERGY HARVESTING THROUGH KNEE JOINT AND FOOT STEP | U. RAMAKRISHNA        |
|   | 13E31A0329 | K.J.V CHAITANYA KUMAR |   |                       |
|   | 13E31A0346 | P. SHARATH CHANDRA    |   |                       |
|   | 13E31A0345 | P. VIJAY KUMAR        |   |                       |
|   | 13E31A0306 | A. SUNIL KUMAR        |   |                       |
| 5 | 13E31A0310 | A. RAKESH             | MODELING AND FABRICATION OF VERTICAL AXIS WIND TURBINE                          | B. VENKATESHWAR REDDY |
|   | 13E31A0349 | R. ANIL KUMAR         |   |                       |
|   | 13E31A0308 | A. PRAVEEN            |   |                       |
|   | 13E31A0319 | CH. VENKATESH         |   |                       |
|   | 13E31A0324 | D.BALAJI              |   |                       |
| 6 | 13E31A0343 | P. VINAY KUMAR        | MODELLING AND FABRICATION OF VERTICAL AXIS WIND TURBINE WITH NOZZLE STRUCTURE   | D. SANTHOSH KUMAR     |
|   | 13E31A0344 | P. RANJITH KUMAR      |   |                       |
|   | 13E31A0311 | A. GOPI               |   |                       |
|   | 13E31A0338 | MD.IRFAN              |   |                       |
|   | 13E31A0312 | A. LOHIT              |   |                       |



|   |            |                     |   |                      |
|---|------------|---------------------|---|----------------------|
| 7 | 13E31A0326 | G.D.V RAMA TEJA     | MODELLING AND FABRICATION OF PNEUMATIC WEIGHT LIFTER            | P. DURGA RAVI PRASAD |
|   | 13E31A0325 | G. SREEDHAR         |   |                      |
|   | 13E31A0309 | A. SAICHAND         |   |                      |
|   | 13E31A0328 | J. AKSHAY           |   |                      |
|   | 13E31A0315 | B. MURALIDHAR       |   |                      |
| 8 | 13E31A0333 | K. KRANTHI KUMAR    | FABRICATION OF PESTISIDE SPRAYER WITH SOLAR POWER               | K. DEVISINGH         |
|   | 13E31A0353 | S. SRIKAR RAJ       |   |                      |
|   | 13E31A0357 | S. SACHIDANAND      |   |                      |
|   | 13E31A0332 | K. VEERENDRA        |   |                      |
|   | 13E31A0314 | B. SANDEEP          |   |                      |
| 9 | 13E31A0354 | MD.RIZWAN SHAH      | DESIGN AND DRAFTING OF HEATING VENTILATION AND AIR CONDITIONING | B. NAGESWAR          |
|   | 13E31A0339 | MD.AHMED MOHI UDDIN |   |                      |
|   | 13E31A0352 | S. MANEESH          |   |                      |
|   | 13E31A0337 | M.SURENDER NAYAK    |   |                      |
|   | 13E31A0360 | B. VIKAS KUMAR      |   |                      |





|    |            |                      |   |                   |
|----|------------|----------------------|---|-------------------|
| 10 | 13E31A0303 | A. MAHESH            | FABRICATION OF<br>SOALR POWERED<br>HACKSAW CUM<br>DRILLING<br>MACHINE                   | P. HARI           |
|    | 13E31A0305 | ALI HASAN            |   |                   |
|    | 13E31A0316 | B. VAMSHI<br>KRUSHNA |   |                   |
|    | 13E31A0320 | CH.<br>KRISHNAKANTH  |   |                   |
|    | 13E31A0340 | MD.SHOAIB ALI        |   |                   |
| 11 | 13E31A0363 | D. MADHUKAR          | FABRICATION OF<br>INTELLIGENT<br>BRAKING SYSTEM   | KRISHNA<br>DEEPAK |
|    | 13E31A0382 | M. NOOR BASHA        |   |                   |
|    | 13E31A0368 | G. VIJAY KUMAR       |   |                   |
|    | 13E31A0377 | K. ADHARSH<br>KUMAR  |   |                   |
| 12 | 13E31A0362 | D. RANJITH           | THERMOELECTRIC<br>GENERATOR<br>BASED ON<br>EXHAUST HEAT<br>RECOVERY OF AN<br>AUTOMOBILE | B.NAGESWAR        |
|    | 13E31A0361 | D.SAI AKASH          |   |                   |
|    | 13E31A0364 | D.ROOP SINGH         |   |                   |
|    | 13E31A0366 | G.VENKATESH          |   |                   |



|    |            |                           |   |              |
|----|------------|---------------------------|---|--------------|
| 13 | 13E31A0370 | J.E.S PHANI<br>KUMAR      | FABRICATION<br>OF<br>REFRIGERATION<br>SYSTEM<br>WORKING ON<br>LPG | V.ARUN       |
|    | 13E31A0365 | E.KAMALAKAR               |   |              |
|    | 13E31A0385 | R. BALRAM                 |   |              |
|    | 13E31A0373 | K. PRAVEEN                |   |              |
| 14 | 13E31A0372 | K .BHARATH<br>SIMHA REDDY | FABRICATION<br>OF SIX LEGGED<br>KINEMATIC<br>WALKER               | SONACHALAM   |
|    | 13E31A0376 | K.SHIVAJI                 |   |              |
|    | 13E31A0369 | J. SHIVARAJ               |   |              |
|    | 13E31A0396 | Y. LALITH<br>KUMAR        |   |              |
| 15 | 13E31A0389 | T. DIVYA TEJA             | FABRICATION<br>OF TREADMILL<br>BICYCLE                            | G.SOMASHEKAR |
|    | 13E31A03A2 | M. NARESH                 |   |              |
|    | 13E31A0395 | V.RAMESH                  |   |              |
|    | 13E31A0394 | T.ASRITH<br>PRASHANTH     |   |              |
|    | 13E31A0391 | T.PRAVEEN                 |   |              |



|    |            |                          |  |                      |
|----|------------|--------------------------|--|----------------------|
| 16 | 13E31A0375 | K.SANDEEP REDDY          | FABRICATION OF WORKING MODEL OF HYDRAULIC EXCAVATOR            | B.VENKATESHWAR REDDY |
|    | 13E31A0381 | MOHITH SR. MANE          |  |                      |
|    | 13E31A0390 | T.VINEETH                |  |                      |
|    | 13E31A0393 | T.RAMESH                 |  |                      |
| 17 | 13E31A0384 | PANDEY PRINCE CHINTAMANI | FABRICATION OF PAPER CUTTING MACHINE BY USING GENEVA MECHANISM | N.SATHISH KUMAR      |
|    | 14E35A0303 | SONU GUPTHA              |  |                      |
|    | 13E31A0387 | SYED MUFAQUAM ALI        |  |                      |
|    | 13E31A0388 | SYED ZIAUDDIN            |  |                      |
| 18 | 13E31A03A0 | MJASVANTH                | FABRICATION OF PNEUMATIC VICE USED FOR HOLDING THE WORKPIECE   | E.KRISHNA DEEPAK     |
|    | 13E31A0379 | M.RAMU                   |  |                      |
|    | 13E31A0398 | G.SRINIVAS               |  |                      |
|    | 13E31A0399 | D.PRANEETH               |  |                      |
|    | 13E31A03A1 | S.ARJUN                  |  |                      |





|    |            |                 |   |           |
|----|------------|-----------------|---|-----------|
| 19 | 13E31A0367 | G.PRADEEP KUMAR | FABRICATION<br>OF TILTING<br>HEADLIGHTS<br>CONTROLLED<br>BY STEERING<br>MECHANISM | MD.SAZZAD |
|    | 13E31A0371 | J.HEMANTH KUMAR |   |           |
|    | 13E31A0383 | P,PRADEEP NAIK  |   |           |
|    | 13E31A0392 | T.SREEKAR       |   |           |

*G.K. Shanmukh Dev*  
HOD

G.K.SHANMUKH DEV  
DEPARTMENT OF MECHANICAL ENGINEERING

  
PRINCIPAL  
MAHAVEER  
INSTITUTE OF SCIENCE & TECHNOLOGY  
Bandlaguda, Hyd-500 005.

MAHAVEER INSTITUTE OF SCIENCE & TECHNOLOGY  
Vyasapuri, Bandlaguda, Keshavagiri Post,  
Hyderabad-500005.

DEPARTMENT OF MECHANICAL ENGINEERING



**CERTIFICATE**

*This is to certify that the Project work entitled "FABRICATION OF MULTI SPINDLE DRILLING MACHINE" that is being submitted by B. Sai Manoj Kumar, J. Naveen, A. Jashwanth Goud, K. Pavan Kumar, T. Anil in partial fulfilment of the requirement for the award of the Degree of Bachelor of Technology in MECHANICAL ENGINEERING from MAHAVEER INSTITUTE OF SCIENCE AND TECHNOLOGY, during the academic year 2016-2017.*

*The results embodied in this project report have not been submitted to any other University or Institute for the award of any degree.*

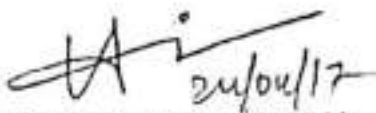
  
Mr. B. HARINATH REDDY  
Assistant Professor  
Internal Guide

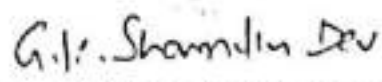
  
Mr. G.K. SHANMUKHI DEV  
Head of the Department

  
PRINCIPAL  
MAHAVEER  
INSTITUTE OF SCIENCE & TECHNOLOGY  
Bandlaguda, Hyd-500 005.

  
EXTERNAL EXAMINER

MAHAVEER INSTITUTE OF SCIENCE & TECHNOLOGY  
Vyasapuri, Bandlaguda, Keshavagiri Post,  
Hyderabad-500005.

DEPARTMENT OF MECHANICAL ENGINEERING



CERTIFICATE

This is to certify that the Project work entitled "MODELLING AND FABRICATION OF VERTICAL AXIS WIND TURBINE WITH NOZZLE STRUCTURE" that is being submitted by P. VINAY KUMAR, P. RANJITH KUMAR, A. GOPI, MD IFRAN, A. LOHITH in partial fulfilment of the requirement for the award of the Degree of Bachelor of Technology in MECHANICAL ENGINEERING from MAHAVEER INSTITUTE OF SCIENCE AND TECHNOLOGY, during the academic year 2016-2017.

The results embodied in this project report have not been submitted to any other University or Institute for the award of any degree.

  
Mr. D. SANTHOSH KUMAR  
Assistant Professor  
Internal Guide

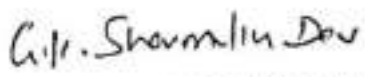
  
Mr. G.K. SHANMUKH DEV  
Head of the Department

  
PRINCIPAL  
MAHAVEER  
INSTITUTE OF SCIENCE & TECHNOLOGY  
Bandlaguda, Hyderabad

  
EXTERNAL EXAMINER

**MAHAVEER INSTITUTE OF SCIENCE & TECHNOLOGY**  
Vyasapuri, Bandlaguda, Keshavagiri Post,  
Hyderabad-500005

**DEPARTMENT OF MECHANICAL ENGINEERING**



**CERTIFICATE**

*This is to certify that the Project work entitled "FABRICATION OF PNEUMATIC VICE USED FOR HOLDING WORKPIECE" that is being submitted by M. Jayvarth, M. Ramu, G. Srinivas, D. Praneeth, S. Arjun in partial fulfilment of the requirement for the award of the Degree of Bachelor of Technology in MECHANICAL ENGINEERING from MAHAVEER INSTITUTE OF SCIENCE AND TECHNOLOGY, during the academic year 2016-2017.*

*The results embodied in this project report have not been submitted to any other University or Institute for the award of any degree.*

*E. Krishna Prath*  
Mr. E. KRISHNA DEEPAK  
Assistant Professor  
Internal Guide

*G.K. Shanmukh Dev*  
Mr. G.K. SHANMUKH DEV  
Head of the Department

*K. Venkatesh*  
PRINCIPAL  
MAHAVEER  
INSTITUTE OF SCIENCE & TECHNOLOGY  
Bandlaguda, Hyd-500 005.

*K. Venkatesh*  
EXTERNAL EXAMINER



# MAHAVEER INSTITUTE OF SCIENCE & TECHNOLOGY

Vyasapuri, Bandlaguda, Keshavagiri Post,

Hyderabad-500005

## DEPARTMENT OF MECHANICAL ENGINEERING



### CERTIFICATE

*This is to certify that the Project work entitled "MODELLING AND FABRICATION OF AUTOMATED SOLAR GRASS CUTTER" that is being submitted by K. Bhavani Sankar, A. Mahesh, S. Srinivas, Ch. Benn Madhav, T. Krishna Rao in partial fulfilment of the requirement for the award of the Degree of Bachelor of Technology in MECHANICAL ENGINEERING from MAHAVEER INSTITUTE OF SCIENCE AND TECHNOLOGY, during the academic year 2016-2017.*

*The results embodied in this project report have not been submitted to any other University or Institute for the award of any degree.*

  
24/04/17

Mr. GANESAN K

Assistant Professor

*Internal Guide*

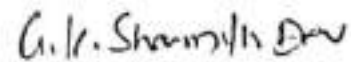

Mr. G.K. SHANMUKH DEV

*Head of the Department*

  
PRINCIPAL  
MAHAVEER  
INSTITUTE OF SCIENCE & TECHNOLOGY  
Bandlaguda, Hyderabad

  
EXTERNAL EXAMINER

# MAHAVEER INSTITUTE OF SCIENCE & TECHNOLOGY

Vyasapuri, Bandlaguda, Keshavagiri Post,  
Hyderabad-500005.

## DEPARTMENT OF MECHANICAL ENGINEERING



### CERTIFICATE

*This is to certify that the Project work entitled "FABRICATION OF SOLAR POWERED HACK SAW CUM DRILLING MACHINE" that is being submitted by A.Mahesh, Ali Hasan Bamasdoos, B. VamshiKrushna, CH. Krishnakanth, Mohammed Shoaib Alin partial fulfilment of the requirement for the award of the Degree of Bachelor of Technology in MECHANICAL ENGINEERING from MAHAVEER INSTITUTE OF SCIENCE AND TECHNOLOGY, during the academic year 2016-2017.*

*The results embodied in this project report have not been submitted to any other University or Institute for the award of any degree.*

Mr. P. HARI  
Assistant Professor  
Internal guide

G.K. Shanmukh Dev  
Mr. G.K. SHANMUKH DEV  
Head of the Department

EXTERNAL EXAMINER

PRINCIPAL  
MAHAVEER  
INSTITUTE OF SCIENCE & TECHNOLOGY  
Bandlaguda, Hyd-500 005.

# MAHAVEER INSTITUTE OF SCIENCE & TECHNOLOGY

Vyasapuri, Bandlaguda, Keshavagiri Post,  
Hyderabad-500005

## DEPARTMENT OF MECHANICAL ENGINEERING



### CERTIFICATE

*This is to certify that the Project work entitled "FABRICATION OF 3 AXIS CNC DRILLING MACHINE" that is being submitted by R. Vamshidher, R. Kamal, S. Mukesh Kumar, B. Akash, M. Akash in partial fulfilment of the requirement for the award of the Degree of Bachelor of Technology in MECHANICAL ENGINEERING from MAHAVEER INSTITUTE OF SCIENCE AND TECHNOLOGY, during the academic year 2016-2017.*

*The results embodied in this project report have not been submitted to any other University or Institute for the award of any degree.*

  
24/4/17  
Mr. SUDHAKAR. S  
Assistant Professor  
Internal Guide

  
Mr. G.K. SHANMUKH DEV  
Head of the Department

  
EXTERNAL EXAMINER

  
PRINCIPAL  
MAHAVEER  
INSTITUTE OF SCIENCE & TECHNOLOGY  
Bandlaguda, Hyd-500 005.

MAHAVEER INSTITUTE OF SCIENCE & TECHNOLOGY  
Vyasapuri, Bandlaguda, Keshavagiri Post,  
Hyderabad-500005.

DEPARTMENT OF MECHANICAL ENGINEERING



**CERTIFICATE**

*This is to certify that the Project work entitled "MODELLING AND FABRICATION OF VERTICAL AXIS WIND TURBINE" that is being submitted by A. Rakesh, A. Praveen, CH. Venkatesh, D. Balaji, R. Anil Kumar in partial fulfilment of the requirement for the award of the Degree of Bachelor of Technology in MECHANICAL ENGINEERING from MAHAVEER INSTITUTE OF SCIENCE AND TECHNOLOGY during the academic year 2016-2017.*

*The results embodied in this project report have not been submitted to any other University or Institute for the award of any degree.*

  
Mr. B. VENKATESHWAR REDDY  
Associate Professor  
Internal Guide

  
Mr. G.K. SHANMUKH DEV  
Head of the Department

  
PRINCIPAL  
MAHAVEER  
INSTITUTE OF SCIENCE & TECHNOLOGY  
Bandlaguda, Hyd-500 005.

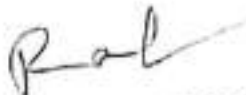
  
EXTERNAL EXAMINER



MAHAVEER INSTITUTE OF SCIENCE & TECHNOLOGY  
Vyasapuri, Bandlaguda, Keshavagiri Post,  
Hyderabad-500005

DEPARTMENT OF MECHANICAL ENGINEERING



**CERTIFICATE**

*This is to certify that the Project work entitled "FABRICATION OF SIX LEGGED KINEMATIC WALKER" that is being submitted by K. Bhurath Simha Reddy, J. Sivaram, K. Shivaji, Y. Lalith Kumar in partial fulfilment of the requirement for the award of the Degree of Bachelor of Technology in MECHANICAL ENGINEERING from MAHAVEER INSTITUTE OF SCIENCE AND TECHNOLOGY, during the academic year 2016-2017.*

*The results embodied in this project report have not been submitted to any other University or Institute for the award of any degree.*

  
Mr. M. SONACHALAM  
Assistant Professor  
Internal Guide

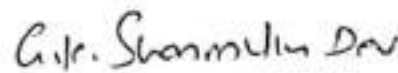
  
Mr. G.K. SHANMUKH DEV  
Head of the Department

  
EXTERNAL EXAMINER

  
PRINCIPAL  
MAHAVEER  
INSTITUTE OF SCIENCE & TECHNOLOGY  
Bandlaguda, Hyd-500 005.

**MAHAVEER INSTITUTE OF SCIENCE & TECHNOLOGY**  
Vyasapuri, Bandlaguda, Keshavagiri Post,  
Hyderabad-500005

**DEPARTMENT OF MECHANICAL ENGINEERING**



CERTIFICATE

*This is to certify that the Project work entitled "FABRICATION OF PESTICIDE SPRAYER WITH SOLAR POWER" that is being submitted by K. Kranthi Kumar , K.Veerendra .B.Sandeep ,S.Sachidanand , S.Srikar Raj in partial fulfilment of the requirement for the award of the Degree of Bachelor of Technology in MECHANICAL ENGINEERING from MAHAVEER INSTITUTE OF SCIENCE AND TECHNOLOGY, during the academic year 2016-2017.*

*The results embodied in this project report have not been submitted to any other University or Institute for the award of any degree.*

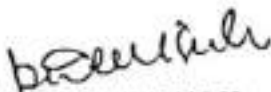
  
Mr. K. DEVI SINGH  
Assistant Professor  
Internal Guide

  
Mr. G.K. SHANMUKH DEV  
Head of the Department

  
EXTERNAL EXAMINER

  
PRINCIPAL  
MAHAVEER  
INSTITUTE OF SCIENCE & TECHNOLOGY  
Bandlaguda, Hyderabad-500005

MAHAVEER INSTITUTE OF SCIENCE & TECHNOLOGY  
Vyasapuri, Bandlaguda, Keshavagiri Post,  
Hyderabad-500005

DEPARTMENT OF MECHANICAL ENGINEERING



## CERTIFICATE

*This is to certify that the Project work entitled "FABRICATION OF FREEDMILL BICYCLE" that is being submitted by T. Divya Teja, T. Praveen, T. Ashrith Prashanth, V Ramesh, Mudlavath Naresh in partial fulfilment of the requirement for the award of the Degree of Bachelor of Technology in MECHANICAL ENGINEERING from MAHAVEER INSTITUTE OF SCIENCE AND TECHNOLOGY, during the academic year 2016-2017.*

*The results embodied in this project report have not been submitted to any other University or Institute for the award of any degree.*

  
Mr. G. SOMASHEKAR  
Assistant Professor  
Internal Guide

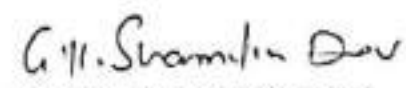
  
Mr. G.K. SHANMUKH DEV  
Head of the Department

  
EXTERNAL EXAMINER

  
PRINCIPAL  
MAHAVEER  
INSTITUTE OF SCIENCE & TECHNOLOGY  
Bandlaguda, Hyd-500 005.

**MAHAVEER INSTITUTE OF SCIENCE & TECHNOLOGY**  
Vyasapuri, Bandlaguda, Keshavagiri Post,  
Hyderabad-500005

**DEPARTMENT OF MECHANICAL ENGINEERING**



**CERTIFICATE**

*This is to certify that the Project work entitled "FABRICATION OF PAPER CUTTING MACHINE BASED ON GENEVA MECHANISM" that is being submitted by Pandey Prince Chintamani, Gupta Somu, Syed Ziauddin, Syed Mofaquam Ali, in partial fulfilment of the requirement for the award of the Degree of Bachelor of Technology in MECHANICAL ENGINEERING from MAHAVEER INSTITUTE OF SCIENCE AND TECHNOLOGY, during the academic year 2016-2017.*

*The results embodied in this project report have not been submitted to any other University or Institute for the award of any degree.*

*Sathish 25/04/17*  
Mr. N SATHISH KUMAR  
Assistant Professor  
Internal Guide

*G.K. Shanmukh Dev*  
Mr. G.K. SHANMUKH DEV  
Head of the Department

*K. Prasa Lak*  
EXTERNAL EXAMINER

*Principal*  
PRINCIPAL  
MAHAVEER  
INSTITUTE OF SCIENCE & TECHNOLOGY  
Bandlaguda, Hyd-500 005.



**MAHAVEER INSTITUTE OF SCIENCE & TECHNOLOGY**

Vyasapuri, Bandlaguda, Keshavagiri Post,

Hyderabad-500005

**DEPARTMENT OF MECHANICAL ENGINEERING**



**CERTIFICATE**

*This is to certify that the Project work entitled "FABRICATION OF WORKING MODEL OF HYDRAULIC EXCAVATOR" that is being submitted by K. Sandeep Reddy, Mohith S.R Mane, Togaram Vineeth, Thota Ramesh in partial fulfilment of the requirement for the award of the Degree of Bachelor of Technology in MECHANICAL ENGINEERING from MAHAVEER INSTITUTE OF SCIENCE AND TECHNOLOGY, during the academic year 2016-2017.*

*The results embodied in this project report have not been submitted to any other University or Institute for the award of any degree.*

  
**Mr. B. VENKATESHWAR REDDY**  
Associate Professor  
Internal Guide

  
**Mr. G.K. SHANMUKH DEV**  
Head of the Department

  
PRINCIPAL  
MAHAVEER  
INSTITUTE OF SCIENCE & TECHNOLOGY  
Vyasapuri, Bandlaguda, Hyderabad-500005

  
EXTERNAL EXAMINER

MAHAVEER INSTITUTE OF SCIENCE & TECHNOLOGY  
Vyasapuri, Bandlaguda, Keshavagiri Post,  
Hyderabad-500005

DEPARTMENT OF MECHANICAL ENGINEERING



CERTIFICATE

*This is to certify that the Project work entitled "THERMOELECTRIC GENERATOR BASED ON EXHAUST HEAT RECOVERY OF AN AUTOMOBILE" that is being submitted by D.Ranjith, D.Sai Akash, D.Roopsingh, G.Venkatesh, in partial fulfilment of the requirement for the award of the Degree of Bachelor of Technology in MECHANICAL ENGINEERING from MAHAVEER INSTITUTE OF SCIENCE AND TECHNOLOGY, during the academic year 2016-2017.*

*The results embodied in this project report have not been submitted to any other University or Institute for the award of any degree.*

Mr. B.NAGSWAR  
Assistant Professor  
Internal Guide

Mr. G.K. SHANMUKH DEV  
Head of the Department

External Examiner

  
PRINCIPAL  
MAHAVEER  
INSTITUTE OF SCIENCE & TECHNOLOGY  
Bandlaguda, Hyd-500 005.

**MAHAVEER INSTITUTE OF SCIENCE & TECHNOLOGY**  
Vyasapuri, Bandlaguda, Keshavagiri Post,  
Hyderabad-500005

**DEPARTMENT OF MECHANICAL ENGINEERING**



**CERTIFICATE**

*This is to certify that the Project work entitled "FABRICATION OF BIOMECHANICAL ENERGY HARVESTING THROUGH KNEE JOINT AND FOOT STEP" that is being submitted by M. Abhinav, K.J.V. Chaitanya Kumar, P. Sharath Chandra, P. Vijay Kumar, A. Sunil Kumar in partial fulfilment of the requirement for the award of the Degree of Bachelor of Technology in MECHANICAL ENGINEERING from MAHAVEER INSTITUTE OF SCIENCE AND TECHNOLOGY, during the academic year 2016-2017.*

*The results embodied in this project report have not been submitted to any other University or Institute for the award of any degree.*

**Mr. U. KAMAKRISHNA**  
Assistant Professor  
*Internal Guide*

**Mr. G.K. SHANMUKH DEV**  
*Head of the Department*

**EXTERNAL EXAMINER**

**PRINCIPAL**  
**MAHAVEER**  
INSTITUTE OF SCIENCE & TECHNOLOGY  
Bandlaguda, Hyd-500 005.

**MAHAVEER INSTITUTE OF SCIENCE & TECHNOLOGY**  
Vyasapuri, Bandlaguda, Keshavagiri Post,  
Hyderabad-500005

**DEPARTMENT OF MECHANICAL ENGINEERING**



**CERTIFICATE**

*This is to certify that the Project work entitled "MODELLING AND FABRICATION OF PNEUMATIC WEIGHT LIFTER" that is being submitted by G.D.V Rama Teja, G.Sreedhar, A.Saichand, J.Akshay, B.Muralidhar in partial fulfilment of the requirement for the award of the Degree of Bachelor of Technology in MECHANICAL ENGINEERING from MAHAVEER INSTITUTE OF SCIENCE AND TECHNOLOGY, during the academic year 2016-2017.*

*The results embodied in this project report have not been submitted to any other University or Institute for the award of any degree.*

**Mr. P. DURGA RAVI PRASAD**  
Assistant Professor  
Internal Guide

**Mr. G.K. SHANMUKH DEV**  
Head of the Department

**EXTERNAL EXAMINER**

**PRINCIPAL**  
**MAHAVEER**  
**INSTITUTE OF SCIENCE & TECHNOLOGY**  
BANDLAGUDA, HYD-500005



MAHAVEER INSTITUTE OF SCIENCE & TECHNOLOGY  
Vyasapuri, Bandlaguda, Keshavagiri Post,  
Hyderabad-500005

DEPARTMENT OF MECHANICAL ENGINEERING



CERTIFICATE

*This is to certify that the Project work entitled "DESIGN AND DRAFTING OF HEATING VENTILATION AND AIR CONDITIONING" that is being submitted by Mohammad Rizwan Shah, Mohammed Ahmed Mohiuddin, M.Surendhar Nayak, S.Maneesh .B.Vikas Kumar in partial fulfilment of the requirement for the award of the Degree of Bachelor of Technology in MECHANICAL ENGINEERING from MAHAVEER INSTITUTE OF SCIENCE AND TECHNOLOGY, during the academic year 2016-2017.*

*The results embodied in this project report have not been submitted to any other University or Institute for the award of any degree.*

  
Mr. NAGESWAR B  
Assistant Professor  
Internal Guide

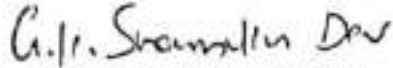
  
Mr. G.K. SHANMUKH DEV  
Head of the Department

  
PRINCIPAL  
MAHAVEER  
INSTITUTE OF SCIENCE & TECHNOLOGY  
Bandlaguda, Hyd-500 005

  
EXTERNAL EXAMINER

# MAHAVEER INSTITUTE OF SCIENCE & TECHNOLOGY

Vyasapuri, Bandlaguda, Keshavagiri Post,  
Hyderabad-500005

## DEPARTMENT OF MECHANICAL ENGINEERING



### CERTIFICATE

*This is to certify that the Project work entitled "FABRICATION OF REFRIGERATION SYSTEM WORKING ON LPG" that is being submitted by J. E. S. Phani Kumar, E. Kumalakur, K.Pravcen, R. Balaram in partial fulfilment of the requirement for the award of the Degree of Bachelor of Technology in MECHANICAL ENGINEERING from MAHAVEER INSTITUTE OF SCIENCE AND TECHNOLOGY, during the academic year 2016-2017.*

*The results embodied in this project report have not been submitted to any other University or Institute for the award of any degree.*

Mr. V. ARUN  
Assistant Professor  
Internal Guide

Mr. G.K. SHANMUKH DEV  
Head of the Department

EXTERNAL EXAMINER

MAHAVEER INSTITUTE OF SCIENCE & TECHNOLOGY  
Vyasapuri, Bandlaguda, Keshavagiri Post,  
Hyderabad-500005

DEPARTMENT OF MECHANICAL ENGINEERING



CERTIFICATE

*This is to certify that the Project work entitled "FABRICATION OF TILTING HEADLIGHTS CONTROLLED BY STEERING MECHANISM" that is being submitted by G.PRADEEP KUMAR, JHEMANTH KUMAR, P.PRADEEP NAIK, T.SREEKAR in partial fulfilment of the requirement for the award of the Degree of Bachelor of Technology in MECHANICAL ENGINEERING from MAHAVEER INSTITUTE OF SCIENCE AND TECHNOLOGY, during the academic year 2016-2017.*

*The results embodied in this project report have not been submitted to any other University or Institute for the award of any degree.*

MD. 

Mr. MD. SAZZAD  
Assistant Professor  
Internal Guide

G.K. Shanmukh Dev

Mr. G.K. SHANMUKH DEV  
Head of the Department



EXTERNAL EXAMINER

  
PRINCIPAL  
MAHAVEER  
INSTITUTE OF SCIENCE & TECHNOLOGY  
HYDARABAD-500005

MAHAVEER INSTITUTE OF SCIENCE & TECHNOLOGY  
Vyasapuri, Bandlaguda, Keshavagiri Post,  
Hyderabad-500005

DEPARTMENT OF MECHANICAL ENGINEERING



CERTIFICATE

*This is to certify that the Project work entitled "FABRICATION OF INTELLIGENT BRAKING SYSTEM" that is being submitted by D.Madhukar, G.Vijay Kumar, K.Adarsh Kumar, M.Noor Basit, in partial fulfilment of the requirement for the award of the Degree of Bachelor of Technology in MECHANICAL ENGINEERING from MAHAVEER INSTITUTE OF SCIENCE AND TECHNOLOGY, during the academic year 2016-2017.*

*The results embodied in this project report have not been submitted to any other University or Institute for the award of any degree.*

*E. Krishna Deak*  
Mr. E.KRISHNADEEPAK  
Assistant Professor  
Internal Guide

*G.K. Shanmukh Dev*  
Mr. G.K. SHANMUKH DEV  
Head of the Department

*K. Prasad Lokesh*  
EXTERNAL EXAMINER

*Krishna*  
MAHAVEER  
INSTITUTE OF SCIENCE & TECHNOLOGY  
Bandlaguda, Hyd-500005



**ECE MAJOR PROJECT(A.Y 2016-17)**

| S.No | Roll No     | Name of Student     | Major Project title  |
|------|-------------|---------------------|--|
| 1    | 13EE31A0401 | A.ANUDEEP KUMAR     | Live Human Detection And Alerting Robot  |
| 2    | 13EE31A0402 | A.KEERTHY PRIYA     | Live Human Detection And Alerting Robot  |
| 3    | 13EE31A0405 | AJMEERA SRINIVASA F | Live Human Detection And Alerting Robot  |
| 4    | 13EE31A0406 | AKSHAY.R            | Live Human Detection And Alerting Robot  |
| 5    | 13EE31A0407 | ANABATHULA SUKUMA   | Live Human Detection And Alerting Robot  |
| 6    | 13EE31A0409 | BATTU PRANEETH KUN  | Wireless Tracking System Medical Equipment   |
| 7    | 13EE31A0410 | CHERUKU BHARATH     | Wireless Tracking System Medical Equipment   |
| 8    | 13EE31A0411 | CHINTHANABOYINA PR  | Wireless Tracking System Medical Equipment   |
| 9    | 13EE31A0412 | CHITUPROLU RAJESH   | Wireless Tracking System Medical Equipment   |
| 10   | 13EE31A0413 | DASARI SAI CHARAN   | Wireless Tracking System Medical Equipment   |
| 11   | 13EE31A0414 | EPPALAPALLI SHIVA K | Implementation Of Advanced Security System For Finding The Helmet And Alcohol Status Of Two Wheeler Vehicles |
| 12   | 13EE31A0415 | G.SAI DEEPTHI       | Implementation Of Advanced Security System For Finding The Helmet And Alcohol Status Of Two Wheeler Vehicles |
| 13   | 13EE31A0416 | G.SAI SWAGATH       | Implementation Of Advanced security system for finding the helmet and alcohol status of two Wheeler Vehicles |
| 14   | 13EE31A0417 | GADDI SAI KRISHNA   | Implementation Of Advanced Security System For Finding The Helmet And Alcohol Status Of Two Wheeler Vehicles |
| 15   | 13EE31A0418 | GAJULA SATISH KUMA  | Implementation Of Advanced Security System For Finding The Helmet And Alcohol Status Of Two Wheeler Vehicles |
| 16   | 13EE31A0421 | JALA HEMANTH CHAN   | Voice Guidance Based GPS Turn By Turn Navigation System  |
| 17   | 13EE31A0423 | KESANA MANI KUMAR   | Voice Guidance Based GPS Turn By Turn Navigation System  |
| 18   | 13EE31A0424 | KANTAM RISHIKKANTH  | Voice Guidance Based GPS Turn By Turn Navigation System  |
| 19   | 13EE31A0425 | KALLEM NIKIL REDDY  | Voice Guidance Based GPS Turn By Turn Navigation System  |
| 20   | 13EE31A0419 | GUNDU MANASA        | Power Saving For Highway And Accident Avoidence With Warning System  |
| 21   | 13EE31A0426 | KOLLU RUPA          | Power Saving For Highway And Accident Avoidence With Warning System  |
| 22   | 13EE31A0428 | KUKATLA NAGESWARA   | Power Saving For Highway And Accident Avoidence With Warning System  |
| 23   | 13EE31A0429 | KURMA SWAPNA        | Power Saving For Highway And Accident Avoidence With Warning System  |
| 24   | 13EE31A0430 | LUKKA DIVYA         | Power Saving For Highway And Accident Avoidence With Warning System  |

*M*

Principal  
 P. Anil Kumar  
 13/11/2016  
 98489 98489



|    |            |                        |   |
|----|------------|------------------------|---|
| 25 | 13E31A0431 | M SAMAJUKTIVA          | Smart Green House Automatic Monitoring And Control              |
| 26 | 13E31A0432 | MAIL APRIYA VISHAL     | Smart Green House Automatic Monitoring And Control              |
| 27 | 13E31A0433 | MAIL ETIYA VIKRANTH    | Smart Green House Automatic Monitoring And Control              |
| 28 | 13E31A0434 | MAIL ETIYA VIKRANTH    | Smart Green House Automatic Monitoring And Control              |
| 29 | 13E31A0435 | MAIL BHUVANIPRIYA RAJU | Smart Green House Automatic Monitoring And Control              |
| 30 | 13E31A0437 | MAIL UJAY MAIL SYAAF   | Development Of An Autonomous Micro Robot For Swarm Robotics     |
| 31 | 13E31A0436 | MODAVATHI PAJJI HIDEI  | Development Of An Autonomous Micro Robot For Swarm Robotics     |
| 32 | 13E31A0437 | MOHAMMED AHMAD OGS     | Development Of An Autonomous Micro Robot For Swarm Robotics     |
| 33 | 13E31A0438 | MORHAN SHWELI HA       | Development Of An Autonomous Micro Robot For Swarm Robotics     |
| 34 | 13E31A0439 | P VENKAT RAGHAVA       | Development Of An Autonomous Micro Robot For Swarm Robotics     |
| 35 | 13E31A0441 | PRASHANT DWIVEDI       | Development Of An Autonomous Micro Robot For Swarm Robotics     |
| 36 | 13E31A0442 | PURI VENKAT RAGHAVA    | Intelligent Plant Pot Using Iot                                 |
| 37 | 13E31A0444 | PRASHANT DWIVEDI       | Zigbee Spy Robot Using Wireless Web Camera                      |
| 38 | 13E31A0445 | R KISHORE REDDY        | Zigbee Spy Robot Using Wireless Web Camera                      |
| 39 | 13E31A0447 | SHAIK ANEEFUDDIN       | Zigbee Spy Robot Using Wireless Web Camera                      |
| 40 | 13E31A0448 | SIDDAM SHIVA PRASAD    | Zigbee Spy Robot Using Wireless Web Camera                      |
| 41 | 13E31A0449 | SILARI MANEESH         | Development Of A Cell Phone Based Vehicle Remote Control System |
| 42 | 13E31A0451 | TELLABOINA UPENDAR     | Development Of A Cell Phone Based Vehicle Remote Control System |
| 43 | 13E31A0452 | T SANJAY SINGH         | Development Of A Cell Phone Based Vehicle Remote Control System |
| 44 | 13E31A0454 | UNDI SREEKANTH RED     | Development Of A Cell Phone Based Vehicle Remote Control System |
| 45 | 13E31A0460 | VENNU RAVICHANDRA      | Development Of A Cell Phone Based Vehicle Remote Control System |
| 46 | 13E31A0453 | THOTA RAVI KUMAR       | Hexapod Walking Robot   |
| 47 | 13E31A0455 | U SINDHUJA             | Hexapod Walking Robot   |
| 48 | 13E31A0456 | VORIGANTI SHRUTHI      | Hexapod Walking Robot   |
| 49 | 13E31A0457 | VANGALA VAISHNAVI      | Hexapod Walking Robot   |
| 50 | 13E31A0458 | V BHUSHAN YADAV        | Hexapod Walking Robot   |
| 51 | 13E31A0459 | VELLAKALLUNKAL DEN     | Hexapod Walking Robot   |
| 52 | 13E31A0461 | A ANURRAG PATEL        | Implementation of Multi Levels of Vehicle Security              |
| 53 | 13E31A0463 | A NEELIMA              | Implementation of Multi Levels of Vehicle Security              |
| 54 | 13E31A0464 | ALICETI SAIRAM         | Implementation of Multi Levels of Vehicle Security              |
| 55 | 13E31A0465 | ANKITA RAO             | Implementation of Multi Levels of Vehicle Security              |
| 56 | 13E31A0466 | ATELY MANISHA          | Implementation of Multi Levels of Vehicle Security              |
| 57 | 13E31A0468 | B TEJA                 | Innovative College Bus Information System Using GSM             |

PRINCIPAL  
M. A. H A V E E R

11-11-2018 11:00:05

11-11-2018 11:00:05



|    |            |                     |   |
|----|------------|---------------------|---|
| 58 | 13E31A0469 | A SRILATHA          | Innovative College Bus Information System Using GSM               |
| 59 | 13E31A0470 | BIJILI PRAKASH      | Innovative College Bus Information System Using GSM               |
| 60 | 13E31A0471 | BOGA SANTHOSH       | Innovative College Bus Information System Using GSM               |
| 61 | 13E31A0472 | D ARUN KUMAR YADAV  | Innovative College Bus Information System Using GSM               |
| 62 | 13E31A0473 | D.SAI MANISHA       | Automatic weather monitoring and Surveillance Robot               |
| 63 | 13E31A0474 | DESHPANDE SHASHAN   | Automatic weather monitoring and Surveillance Robot               |
| 64 | 13E31A0475 | DHARANIKAR ARVIND H | Automatic weather monitoring and Surveillance Robot               |
| 65 | 13E31A0476 | DOMMATI RAKESH      | Automatic weather monitoring and Surveillance Robot               |
| 66 | 13E31A0477 | G SHYLJA            | Automatic weather monitoring and Surveillance Robot               |
| 67 | 13E31A0479 | GAJJALA SANJAY KUMI | Metal detector robotic vehicle with GPS positioning               |
| 68 | 13E31A0480 | GOVURU BHARATHKU    | Metal detector robotic vehicle with GPS positioning               |
| 69 | 13E31A0481 | GULAMI NABI ZAKIR   | Metal detector robotic vehicle with GPS positioning               |
| 70 | 13E31A0485 | KACHAVARAPU KRANT   | Metal detector robotic vehicle with GPS positioning               |
| 71 | 13E31A0487 | KATAKANI SHARAILA   | Anti Theft Alert System For ATM Machine                           |
| 72 | 13E31A0488 | KODIPELLY VINISHA   | Anti Theft Alert System For ATM Machine                           |
| 73 | 13E31A0489 | KOLANU MADHU MOHA   | Anti Theft Alert System For ATM Machine                           |
| 74 | 13E31A0490 | KOMMULA RAJASHEKA   | Anti Theft Alert System For ATM Machine                           |
| 45 | 13E31A0491 | LAKAVATH AKHIL      | Anti Theft Alert System For ATM Machine                           |
| 76 | 13E31A0492 | LAVUDYA SRIKANTH    | IoT for Smart Home System Security                                |
| 77 | 13E31A0493 | LINGANABATHINA RAJ  | IoT for Smart Home System Security                                |
| 78 | 13E31A0494 | MADAVARAMI ANIL KUN | IoT for Smart Home System Security                                |
| 79 | 13E31A0496 | MANCHALA MOUNIKA    | IoT for Smart Home System Security                                |
| 80 | 13E31A0497 | MUDAVATH MAHESH     | Smoke And Fire Detecting System With Water Sprinkler Extinguisher |
| 81 | 13E31A0499 | MUNUKUTLA VENKATA   | Smoke And Fire Detecting System With Water Sprinkler Extinguisher |
| 82 | 13E31A04A0 | N ABHILASH          | Smoke And Fire Detecting System With Water Sprinkler Extinguisher |
| 83 | 13E31A04A1 | NAMPELTY SHYLJA     | Smoke And Fire Detecting System With Water Sprinkler Extinguisher |
| 84 | 13E31A04A2 | OMPRAKASH CHENNA    | Smoke And Fire Detecting System With Water Sprinkler Extinguisher |
| 85 | 13E31A04A3 | R.VINOD REDDY       | Smoke And Fire Detecting System With Water Sprinkler Extinguisher |
| 86 | 13E31A04A4 | B N ROHITH          | Speed Control and Route Display for Vehicles In Restricted Areas  |
| 87 | 13E31A04A5 | RAMINI POOJA        | Speed Control and Route Display for Vehicles In Restricted Areas  |
| 88 | 13E31A04A6 | SUNKARI VAMSHI KRIS | Speed Control and Route Display for Vehicles In Restricted Areas  |
| 89 | 13E31A04A8 | THUNGALA NAGARAJU   | Speed Control and Route Display for Vehicles In Restricted Areas  |
| 90 | 13E31A04A9 | VAKITI VINAY KUMAR  | Speed Control and Route Display for Vehicles In Restricted Areas  |
| 91 | 13E31A04B0 | VASPARI SHIVAKUMAR  | Speed Control and Route Display for Vehicles In Restricted Areas  |

Handwritten signature in green ink.

|     |            |                     |   |
|-----|------------|---------------------|---|
| 92  | 13E31A04B1 | BAVANDLA SAI KIRAN  | Automatic vehicle over speed controlling system at zones with location indication |
| 93  | 13E31A04B2 | CHIKOTI SHRAVYA     | Automatic vehicle over speed controlling system at zones with location indication |
| 94  | 13E31A04B5 | GANGISETTY SRIKANTI | Automatic vehicle over speed controlling system at zones with location indication |
| 95  | 13E31A04B6 | K HARI SAI          | Automatic vehicle over speed controlling system at zones with location indication |
| 96  | 13E31A04B7 | KATTULA KALESHWAR   | Automatic vehicle over speed controlling system at zones with location indication |
| 97  | 13E31A04C0 | P SWETHU KRISHNA    | Traffic Congestion and Warning System   |
| 98  | 13E31A04C1 | PESHMAM MOHAMMED    | Traffic Congestion and Warning System   |
| 99  | 13E31A04C2 | RACHA HARIPRIYA     | Traffic Congestion and Warning System   |
| 100 | 13E31A04C4 | SHABAD NAGARAJU     | Traffic Congestion and Warning System   |
| 101 | 13E31A04C5 | VEGUNTA HEMA MONI   | Traffic Congestion and Warning System   |
| 102 | 13E31A04C6 | VOLETTI SATHYAVANI  | Implementation of modern irrigation systems                                       |
| 103 | 13E31A04C8 | AKHIL RAJ           | Implementation of modern irrigation systems                                       |
| 104 | 14E35A0402 | G NIROSHA           | Implementation of modern irrigation systems                                       |
| 105 | 14E35A0404 | M SRAVAN            | Implementation of modern irrigation systems                                       |
| 106 | 13D61A0405 | MIR HANS BAQUER AL  | Implementation of modern irrigation systems                                       |

Co-ordinator

HOD, ECE Dept

*Kandam*  
**PRINCIPAL**  
**M.A. RAJAN VEER**  
**DEPARTMENT OF SCIENCE & TECHNOLOGY**  
**28-5-2020, HYD-500 005.**



, Bandlaguda Post:Keshavgiri,  
Hyd-500 005, TS, INDIA  
20020772,20020773,,Fax: 040-24455003  
ihod.ece@gmail.com,  
www.mist.ac.in

# MAHAVEER

INSTITUTE OF SCIENCE & TECHNOLOGY

Approved by AICTE, Affiliated to JNTUH,Hyd.



## CERTIFICATE

This is to certify that the project work entitled "IMPLEMENTATION OF MULTI LEVEL OF VEHICLE SECURITY" is submitted by

|                |  |            |
|----------------|--|------------|
| A.ANURAG PATEL |  | 13E31A0461 |
| A.NEELIMA      |  | 13E31A0463 |
| A.SAIRAM       |  | 13E31A0464 |
| ANKITA RAO     |  | 13E31A0465 |
| A.MANISHA      |  | 13E31A0466 |

in partial fulfillment of the requirements for the Degree of Bachelor of Technology in Electronics and Communication Engineering of Mahaveer Institute Of Science and Technology, Hyderabad, during the academic year 2016-17, is a bonafide record of work carried out under our guidance and supervision.

The results embodied in this report have not been submitted to any other university or Institution for the award of any degree or diploma.

M.Obula Reddy

Assoc Professor

Guide

15/04/17

K.Venkateswarulu

Asst.Professor

Co-ordinator

Dr.V.Gunasekhar Reddy

Professor & HOD

Head of the Dept.



External Examiner

PRINCIPAL  
MAHAVEER  
INSTITUTE OF SCIENCE & TECHNOLOGY  
Bandlaguda, Hyd-500 005



**CONSCIENCE TECHNOLOGIES**

A RIGHT PLATFORM FOR ALL ENGINEERS

## Certificate

|                 |            |
|-----------------|------------|
| A. ANURAG PATEL | 13E31A0461 |
| A. NEELIMA      | 13E31A0463 |
| ALIGETI SAIRAM  | 13E31A0464 |
| ANKITA RAO      | 13E31A0465 |
| A.MANISHA       | 13E31A0466 |

This is to certify that the above students of MAHAVEER INSTITUTE OF SCIENCE & TECHNOLOGY, Hyderabad, Studying B.Tech (E.C.E) final year, have completed their major projects with us on "IMPLEMENTATION OF MULTI - LEVEL OF VEHICLE SECURITY" in the ECE Dept. Labs. For the partial fulfillment of the award of "Bachelor of Technology in E.C.E" During the period of 24th DEC 2016 to 2nd MAR 2017

For CONSCIENCE TECHNOLOGIES







## CERTIFICATE

This is to certify that the project work entitled " **METAL DETECTOR ROBOTIC VEHICLE WITH GPS POSITIONING** " is submitted by

|                          |              |
|--------------------------|--------------|
| Gajjala Sanjay Kumar     | (13E31A0479) |
| Govuru Bharath Kumar     | (13E31A0480) |
| Gulam Nabi Zakir         | (13E31A0481) |
| Kachavarapu Kranthirekha | (13E31A0485) |

in partial fulfillment of the requirements for the Degree of Bachelor of Technology in **Electronics and Communication Engineering** of Mahaveer Institute Of Science and Technology, Hyderabad, during the academic year 2016-17, is a bonafide record of work carried out under our guidance and supervision.

The results embodied in this report have not been submitted to any other university or Institution for the award of any degree or diploma.

  
R. Prabhakar  
Asst. Professor  
Guide

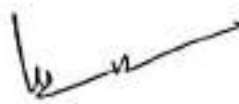
  
K. Venkateswarlu  
Asst. Professor  
SEC-B  
Project Incharge

  
Dr. V. Gunasekhar Reddy  
Professor  
Head of the Dept.



  
External Examiner

  
PRINCIPAL  
MAHAVEER  
INSTITUTE OF SCIENCE & TECHNOLOGY  
Bandlaguda, Hyd-500 005.

## Certificate

GAJJALA SANJAY KUMAR

13E31A0479

GOVURU BHARATH KUMAR

13E31A0480

GULAM NABI ZAKIR

13E31A0481

KACHAVARAPU KRANTHI REKHA

13E31A0485

This is to certify that the above students of MAHAVEER INSTITUTE OF SCIENCE & TECHNOLOGY, Hyderabad, Studying B.Tech (E.C.E) final year, have completed their major project with us on "METAL DETECTOR ROBOTIC VEHICLE WITH GPS POSITIONING" in the ECE Dept. Labs. For the partial fulfillment of the award of "Bachelor of Technology in E.C.E" During the period of 24th DEC 2016 to 2nd MAR 2017

For CONSCIENCE TECHNOLOGIES

Project Manager

Y.S.REDDY



*K. Ramesh*  
PRINCIPAL  
MAHAVEER  
INSTITUTE OF SCIENCE & TECHNOLOGY  
Bandlaguda, Hyd-500 005.

Address

#17-83/2G, 3rd Floor, Opp. Bank of Maharashtra,  
Annapurna Junction Hall Line,  
Dilsukhnagar, Hyderabad-500050.



☎ 040-5012-1199



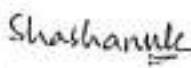
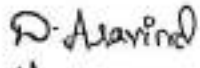

**CERTIFICATE**

This is to certify that the project work entitled " AUTOMATIC WEATHER MONITORING AND SURVEILLANCE ROBOT" is submitted by

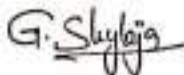
|                                 |   |              |
|---------------------------------|---|--------------|
| D. SAI MANISHA                  |  | (13E31A0473) |
| D. DESHPANDE SHASHANNAK SANTOSH |  | (13E31A0474) |
| D. ARAVIND KUMAR                |  | (13E31A0475) |
| D. RAKESH                       |  | (13E31A0476) |
| G. SHYLAJA                      |  | (13E31A0477) |

in partial fulfillment of the requirements for the Degree of Bachelor of Technology in *Electronics and Communication Engineering* of Mahaveer Institute Of Science and Technology, Hyderabad, during the academic year 2016-17, is a bonafide record of work carried out under our guidance and supervision.

The results embodied in this report have not been submitted to any other university or Institution for the award of any degree or diploma.

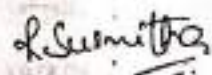
  
R. Susmitha  
Assistant Professor  
Guide

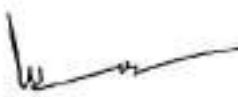
  
K. Venkateswarlu  
Assistant Professor  
Co-ordinator

  
Dr. V. Gunasekhar Reddy  
Professor & HOD  
Head of Dept.



  
External Examiner

  
PRINCIPAL  
MAHAVEER  
INSTITUTE OF SCIENCE & TECHNOLOGY  
Bandlaguda, Hyd-500 005

# Certificate

|                             |            |
|-----------------------------|------------|
| D. SAI MANISHA              | 13E31A0473 |
| DESHPANDE SHASHANNK SANTOSH | 13E31A0474 |
| D. ARAVIND KUMAR            | 13E31A0475 |
| D. RAKESH                   | 13E31A0476 |
| G. SHYLAJA                  | 13E31A0477 |

This is to certify that the above students of MAHAVEER INSTITUTE OF SCIENCE & TECHNOLOGY, Hyderabad, Studying B.Tech (E.C.E) final year, have completed their major project with us on "AUTOMATIC WEATHER MONITORING AND SURVEILLANCE ROBOT" in the ECE Dept. Labs. For the partial fulfillment of the award of 'Bachelor of Technology in E.C.E' During the period of 24th DEC 2016 to 1st MAR 2017

*Handwritten signature*

PRINCIPAL  
MAHAVEER  
INSTITUTE OF SCIENCE & TECHNOLOGY  
Banjara Hills, Hyd-500 005.





apurt, Bandlaguda Post:Keshavgiri,  
Hyderabad-500 005, TS, INDIA  
040-20020772,20020773,,Fax: 040-24455003  
e-mail: [info@ecefitmail.com](mailto:info@ecefitmail.com),  
www: [www.mist.ac.in](http://www.mist.ac.in)

# MAHAVEER

INSTITUTE OF SCIENCE & TECHNOLOGY  
Approved by AICTE, Affiliated to JNTUH,Hyd.



## CERTIFICATE

This is to certify that the project work entitled " AN INNOVATIVE COLLEGE BUS INFORMATION SYSTEM FOR STUDENTS USING GSM" is submitted by

|                    |                    |            |
|--------------------|--------------------|------------|
| B.TEJA             | <i>Bteja</i>       | 13E31A0468 |
| A.SRI LATHA        | <i>A Sri Latha</i> | 13E31A0469 |
| B.PRAKASH          | <i>B Prakash</i>   | 13E31A0470 |
| B.SANTHOSH         | <i>Banthosh</i>    | 13E31A0471 |
| D.ARUN KUMAR YADAV | <i>D Arun</i>      | 13E31A0472 |

in partial fulfillment of the requirements for the Degree of Bachelor of Technology in Electronics and Communication Engineering of Mahaveer Institute Of Science and Technology, Hyderabad, during the academic year 2016-17, is a bonafide record of work carried out under our guidance and supervision.

The results embodied in this report have not been submitted to any other university or Institution for the award of any degree or diploma.

*M Prashanth*  
18/4/17  
M. Prashanth  
Asst.Professor  
Guide

*K Venkateswarlu*  
K. Venkateswarlu  
Asst. Professor  
Project co-ordinator

*Dr. V. Gunasekhar Reddy*  
Dr. V. Gunasekhar Reddy  
Professor  
Head of the Dept.

*External Examiner*  
External Examiner



*K. Srinivas*  
PRINCIPAL  
MAHAVEER  
INSTITUTE OF SCIENCE & TECHNOLOGY  
Bandlaguda, Hyd-500 005.

# Certificate

|                     |            |
|---------------------|------------|
| B. TEJA             | 13E31A0468 |
| A. SRILATHA         | 13E31A0469 |
| B. PRAKASH          | 13E31A0470 |
| B. SANTHOSH         | 13E31A0471 |
| D. ARUN KUMAR YADAV | 13E31A0472 |

This is to certify that the above students of MAHAVEER INSTITUTE OF SCIENCE & TECHNOLOGY, Hyderabad, Studying B.Tech (E.C.E) final year, have completed their major project with us on "AN INNOVATIVE SYSTEM OF COLLEGE BUS INFORMATION FOR STUDENT USING GSM " in the ECE Dept. Labs. For the partial fulfillment of the award of "Bachelor of Technology in E.C.E" During the period of 24th DEC 2016 to 2nd MAR 2017

For CONSCIENCE TECHNOLOGIES



**K. Srinivas MAHAVEER**  
INSTITUTE OF SCIENCE & TECHNOLOGY  
Bandlaguda, Hyd-500 005.





## CERTIFICATE

This is to certify that the project work entitled "Speed Control and Route Display for Vehicles in Restricted Area" is submitted by

|                        |  |            |
|------------------------|--|------------|
| B.N.ROHIT              |  | 13E31A04A4 |
| RAMINI POOJA           |  | 13E31A04A5 |
| SUNKARI VAMSHI KRISHNA |  | 13E31A04A6 |
| TUNGALA NAGARAJU       |  | 13E31A04A8 |
| VAKITI VINAY KUMAR     |  | 13E31A04A9 |
| VASPARI SHIVA KUMAR    |  | 13E31A04B0 |

in partial fulfillment of the requirements for the Degree of Bachelor of Technology in **Electronics and Communication Engineering** of Mahaveer Institute of Science and Technology, Hyderabad, during the academic year 2016-17, is a bona fide record of work carried out under our guidance and supervision.

The results embodied in this report have not been submitted to any other university or Institution for the award of any degree or diploma.

G. Krishna Murthy  
Assoc.Professor  
Guide



K. Venkateswarlu  
Asst.Professor  
Project Incharge

External Examiner

Dr. V. Ganasekhar Reddy  
Professor  
Head of the dept.

PRINCIPAL  
MAHAVEER INSTITUTE OF SCIENCE & TECHNOLOGY  
BANDLAGUDA POST, HYD-500005



## Certificate

|                        |            |
|------------------------|------------|
| B.N. ROHITH            | 13E31A04A4 |
| RAMINI POOJA           | 13E31A04A5 |
| SUNKARI VAMSHI KRISHNA | 13E31A04A6 |
| TUNGALA NAGARAJU       | 13E31A04A8 |
| VAKITI VINAY KUMAR     | 13E31A04A9 |
| VASPARI SHIVA KUMAR    | 13E31A04B0 |

This is to certify that the above students of MAHAVEER INSTITUTE OF SCIENCE & TECHNOLOGY, Hyderabad, Studying B.Tech (E.C.E) final year, have completed their major project with us on "SPEED CONTROL AND ROUTE DISPLAY FOR VEHICLES IN RESTRICTED AREAS" in the ECE Dept. Labs. For the partial fulfillment of the award of "Bachelor of Technology in E.C.E" During the period of 24th DEC 2016 to 2nd MAR 2017

For **CONSCIENCE TECHNOLOGIES**



*Principal*  
**PRINCIPAL**  
**MAHAVEER**  
INSTITUTE OF SCIENCE & TECHNOLOGY  
B.S. Road, Hyderabad-500060.



sepur, Bandlaguda Post:Keshavngrl,  
Hydrabad-500 005, TS, INDIA  
: 040-20020772, 20020773, Fax: 040-24455003  
mail: [931vod.eco@gmail.com](mailto:931vod.eco@gmail.com),  
bslto: [www.mlst.ac.in](http://www.mlst.ac.in)

**MAHAVEER**

INSTITUTE OF SCIENCE & TECHNOLOGY  
Approved by AICTE, Affiliated to JNTU(H),hyd



## CERTIFICATE

This is to certify that the project work entitled "DEVELOPMENT OF SOFTWARE FOR ARM -9 BASED RECIEVER CONTROLLER IN ELECTRONIC INTELLIGENT SYSTEMS" is submitted by

*M. Archana Reddy*  
**M ARCHANA REDDY**

13E31A0495

in partial fulfillment of the requirements for the Degree of Bachelor of Technology in Electronics and Communication Engineering of Mahaveer Institute Of Science and Technology, Hyderabad, during the academic year 2016-17, is a bonafide record of work carried out under our guidance and supervision.

The results embodied in this report have not been submitted to any other university or Institution for the award of any degree or diploma.

**K Venkateshwarlu**  
Asst.Professor  
Guide

**K Venkateshwarlu**  
Asst.Professor  
Project Incharge

**D.V. Chinnababu Reddy**  
Professor  
Head of the Dept.



*K. Venkateshwarlu*  
**PRINCIPAL**  
**MAHAVEER**  
INSTITUTE OF SCIENCE & TECHNOLOGY  
Bandlaguda, Hyd-500 005.



Uppuri, Bandlaguda Post:Koshavgiri,  
Hyderabad-500 005, TS, INDIA  
040-20020772,20020773,, Fax: 040-24455003  
E: [info@mahaveer.edu.in](mailto:info@mahaveer.edu.in),  
Website: [www.mahaveer.edu.in](http://www.mahaveer.edu.in)

**MAHAVEER**  
INSTITUTE OF SCIENCE & TECHNOLOGY  
Approved by AICTE, Affiliated to JNTUH,Hyd.



## CERTIFICATE

This is to certify that the project work entitled "SMOKE AND FIRE DETECTING SYSTEM WITH WATER SPRINKLER EXTINGUISHER" is submitted by

|                               |            |
|-------------------------------|------------|
| M.MAHESH                      | 13E31A0497 |
| M.V.S.RAMAKRISHNA             | 13E31A0499 |
| N.ABHILASH                    | 13E31A04A0 |
| N.SHYLAJA                     | 13E31A04A1 |
| OM PRAKASH CHENNAIAH PANTGANE | 13E31A04A2 |
| R.VINOD REDDY                 | 13E31A04A3 |

in partial fulfillment of the requirements for the Degree of Bachelor of Technology in *Electronics and Communication Engineering* of Mahaveer Institute Of Science and Technology, Hyderabad, during the academic year 2016-17, is a bonafide record of work carried out under our guidance and supervision.

The results embodied in this report have not been submitted to any other university or Institution for the award of any degree or diploma.

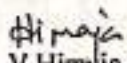
  
V.Himaja  
Asst.Professor  
Guide

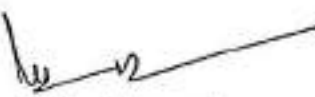
  
K.Venkateswarlu  
Asst.Professor  
Project Incharge

  
Dr. V. Ganasekhar Reddy  
Professor  
Head of the dept.

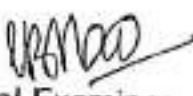

  
External Examiner

  
PRINCIPAL  
MAHAVEER  
INSTITUTE OF SCIENCE & TECHNOLOGY  
Bandlaguda Post, Uppuri - 500 005.

## Certificate

|                                |            |
|--------------------------------|------------|
| I.MAHESH                       | 13E31A0097 |
| I.V.S.RAMAKRISHNA              | 13E31A0099 |
| LABHILASHI                     | 13E31A01A0 |
| ISHYLAJA                       | 13E31A01A1 |
| M PRAKASHI CHENNAIAH PANTEGANI | 13E31A01A2 |
| .VINOD REDDY                   | 13E31A01A3 |

This is to certify that the above students of MAHAVEER INSTITUTE OF SCIENCE & TECHNOLOGY, Hyderabad, Studying B.Tech (E.C.E) final year, have completed their major projects with us on "SMOKE AND FIRE DETECTING SYSTEM WITH WATER SPRINKLER EXTINGUISHER" in the ECE Dept. Labs. For the partial fulfillment of the award of "Bachelor of Technology in E.C.E" During the period of 24th DEC 2016 to 2nd MAR 2017

For  
CONSCIENCE TECHNOLOGIES



*Handwritten signature*

13E31A01A3





## CERTIFICATE

This is to certify that the project work entitled "Automatic vehicle over speed controlling system at zones with location indication" is submitted by

B. Sai Kiran

Ch. Shravya

G. Srikanth

K. Harisal

K. Kaleshwar

(13E31A04B1), *B. Sai Kiran*

(13E31A04B2), *Ch. Shravya*

(13E31A04B5), *G. Srikanth*

(13E31A04B6), *K. Harisal*

(13E31A04B7), *K. Kaleshwar*

In partial fulfillment of the requirements for the Degree of Bachelor of Technology in **Electronics and Communication Engineering** of Mahaveer Institute Of Science and Technology, Hyderabad, during the academic year 2016-17, is a bonafide record of work carried out under our guidance and supervision.

The results embodied in this report have not been submitted to any other university or Institution for the award of any degree or diploma.

K. Venkateswarlu  
Asst. Professor  
Guide

K. Venkateswarlu  
Asst. Professor  
SEC-C  
Project Incharge

Dr. V. Gunasekhar Reddy  
Professor  
Head of the dept.



External Examiner

*Principal*  
PRINCIPAL  
MAHAVEER  
INSTITUTE OF SCIENCE & TECHNOLOGY  
BANDLAGUDA, HYD-500 005



## Certificate

|              |            |
|--------------|------------|
| D.SAIKIRAN   | 13E31A04B1 |
| CH. SHRAVYA  | 13E31A04B2 |
| G. SRIKANTH  | 13E31A04B5 |
| K. HARISAI   | 13E31A04B6 |
| K. KALESHWAR | 13E31A04B7 |

This is to certify that the above students of MAHAVEER INSTITUTE OF SCIENCE & TECHNOLOGY, Hyderabad, Studying B.Tech (E.C.E) final year, have completed their major project with us on "AUTOMATIC VEHICLE OVER SPEED CONTROLLING AT ZONES WITH LOCATION INDICATION" in the ECE Dept. Labs. For the partial fulfillment of the award of "Bachelor of Technology in E.C.E" During the period of 24th DEC 2016 to 2nd MAR 2017

CONSCIENCE TECHNOLOGIES



Address

#17-53/2C, 3rd Floor, Opp. Bank of  
Karnataka, Pochamma Hill, Line,  
D. V. Road, Hyderabad-500028





## CERTIFICATE

This is to certify that the project work entitled "**TRAFFIC CONGESTION AND WARNING SYSTEM**" is submitted by

|                                 |             |
|---------------------------------|-------------|
| P.SWETHU KRISHNA <i>Swetha</i>  | 13E31A04C0, |
| P.MOHAMMED TAIB <i>Taib</i>     | 13E31A04C1, |
| R.HARIPRIYA <i>R. Haripriya</i> | 13E31A04C2, |
| S.NAGARAJU <i>S. Nagaraju</i>   | 13E31A04C4, |
| VILMONICA <i>Monica</i>         | 13E31A04C5. |

in partial fulfillment of the requirements for the Degree of Bachelor of Technology in **Electronics and Communication Engineering** of Mahaveer Institute Of Science and Technology, Hyderabad, during the academic year 2016-17, is a bonafide record of work carried out under our guidance and supervision.

The results embodied in this report have not been submitted to any other university or Institution for the award of any degree or diploma.

  
Deepa M.N  
Asst. Professor  
Guide

  
K. Venkateswarlu  
Asst. Professor  
SEC-C  
Project Incharge

  
Dr. V. Gunasekhar Reddy  
Professor  
Head of the dept.



  
External Examiner

  
PRINCIPAL  
MAHAVEER



## Certificate

|                   |            |
|-------------------|------------|
| P. SWETHU KRISHNA | 13E31A04C0 |
| P. MOHAMMED TAIB  | 13E31A04C1 |
| R. HARIPRIYA      | 13E31A04C2 |
| S. NAGARAJU       | 13E31A04C4 |
| VH. MONICA        | 13E31A04C5 |

This is to certify that the above students of MAHAVEER INSTITUTE OF SCIENCE & TECHNOLOGY, Hyderabad, Studying B.Tech (E.C.E) final year, have completed their major project with us on "TRAFFIC CONGESTION AND WARNING SYSTEM" in the ECE Dept. Labs. For the partial fulfillment of the award of "Bachelor of Technology in E.C.E" During the period of 24th DEC 2016 to 2nd MAR 2017

FOR CONSCIENCE TECHNOLOGIES

Project Manager:



Address

#17-33/2C, 3rd Floor, Opp. Bank of Maharashtra,

Amrampeta Junction, Hall 115,

Durgam Cheru, Hyderabad

*W. Srinivas*  
PRINCIPAL  
MAHAVEER



Vysapur, Bandlaguda Post Keshavnagar,  
Hyderabad-500 005, TS, INDIA  
Tel: 040-20020772, 20020773, Fax: 040-24455003  
E-mail: [ehod.ecet@gmail.com](mailto:ehod.ecet@gmail.com),  
Website: [www.mist.ac.in](http://www.mist.ac.in)

# MAHAVEER

INSTITUTE OF SCIENCE & TECHNOLOGY

Approved by AICTE, Affiliated to JNTU(H),Hyd.



## CERTIFICATE

This is to certify that the project work entitled "INTELLIGENT PLANT POT USING IOT" is submitted by

P. VENKAT RAGHAVA

13E31A0442

in partial fulfillment of the requirements for the Degree of Bachelor of Technology in Electronics and Communication Engineering of Mahaveer Institute Of Science and Technology, Hyderabad, during the academic year 2016-17, is a bonafide record of work carried out under our guidance and supervision.

The results embodied in this report have not been submitted to any other university or Institution for the award of any degree or diploma.

Ravi Kumar  
Assistant Professor  
Guide

N. Ravi Kumar  
Assistant Professor  
Project Coordinator

Dr. V. Gunasekhar Reddy  
Professor  
Head of the Dept.



External Examiner

PRINCIPAL

MAHAVEER

INSTITUTE OF SCIENCE & TECHNOLOGY  
Bandlaguda, Hyd-500 005.





इलेक्ट्रॉनिक्स कारपोरेशन आफ इण्डिया लिमिटेड  
**Electronics Corporation of India Limited**  
CIN U32100TG1967GOI001149  
(भारत सरकार का उद्यम) / (A Govt. of India Enterprise)  
कम्प्यूटर शिक्षा प्रभाग / COMPUTER EDUCATION DIVISION



## CERTIFICATION OF PROJECT COMPLETION

Date: 25/03/2017

This is to certify that Mr. P. VENKAT RAGHAVA (13E31A0442) is a student of "MAHAVEER INSITITUTE OF SCIENCE AND TECHNOLOGY" pursuing B.Tech., (ELECTRONICS AND COMMUNICATION ENGINEERING) has done his project work in "INTELLIGENT PLANT POT USING IOT" during 26-12-2016 to 25-01-2017 in partial fulfilment for the award of the certificate in the degree mentioned above and that this report is a bonafide account of the project work carried out under our guidance. The student displayed analytical capability, has an innovative approach to solve problems and has produced good results.

  
N.S. SEKHAR BABU  
INCHARGE, CED

N.S. SEKHAR BABU  
INCHARGE, CED, ECIL,  
HYDERABAD-500 062.



अतिथि गृह कॉम्प्लेक्स, ई सी आई एन, हैदराबाद, तेलंगाना, भारत.  
Guest House Complex, ECIL, Hyderabad - 500 062. T.S., INDIA.  
दूरभाष / Tel. 2712 5709, 2712 2816, टेली फैक्स / Tele Fax : +91-040-2712 6017  
वेब साइट / Web Site : [www.ecil.co.in](http://www.ecil.co.in), ई-मेल / E-mail : [headced@ecil.co.in](mailto:headced@ecil.co.in)



# MAHAVEER

INSTITUTE OF SCIENCE & TECHNOLOGY

Approved by AICTE, Affiliated to JNTUH, Hyd.



Bandlaguda Post: Keshavnagar,  
Hyderabad-500 005, TS, INDIA  
Tel: 040-20020772, 20020773, Fax: 040-24455003  
E-mail: g.lakshmi@vsnl.com  
Website: www.mist.ac.in

## CERTIFICATE

This is to certify that the project work entitled "HEXAPOD WALKING ROBOT" is submitted by

By

|                  |            |
|------------------|------------|
| T. RAVI KUMAR    | 13E31A0453 |
| U. SINDHUJA      | 13E31A0455 |
| V. SHRUTHI       | 13E31A0456 |
| V. VAISHNAVI     | 13E31A0457 |
| V. BUSHAN YADAV  | 13E31A0458 |
| V. DENISENJOSHUA | 13E31A0459 |

in partial fulfillment of the requirements for the Degree of Bachelor of Technology in *Electronics and Communication Engineering* of Mahaveer Institute Of Science and Technology, Hyderabad, during the academic year 2016-17, is a bonafide record of work carried out under our guidance and supervision.

The results embodied in this report have not been submitted to any other university or Institution for the award of any degree or diploma.

  
G. Rupa Lakshmi

Asst. Professor

Guide

  
N. Ravi Kumar

Asst. Professor

Co-ordinator

  
Dr. V. Gunashekar Reddy

Professor & HOD

Head Of Dept.

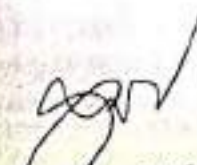

  
External Examiner

  
PRINCIPAL  
MAHAVEER  
INSTITUTE OF SCIENCE & TECHNOLOGY  
Hyderabad-500 005





## CERTIFICATE

This is to certify that the project work entitled "DEVELOPMENT OF CELLPHONE BASED VEHICLE REMOTE CONTROL SYSTEM" is submitted by

|                        |            |
|------------------------|------------|
| SILARI MANEESH         | 13E31A0449 |
| TELLABOINA UPENDAR RAO | 13E31A0451 |
| T.SANJAY SINGH         | 13E31A0452 |
| UNDI SREEKANTH REDDY   | 13E31A0454 |
| VENNU RAVICHANDRA      | 13E31A0460 |

in partial fulfillment of the requirements for the Degree of Bachelor of Technology in Electronics and Communication Engineering of Mahaveer Institute Of Science and Technology, Hyderabad, during the academic year 2013-17, is a bonafide record of work carried out under our guidance and supervision.

The results embodied in this report have not been submitted to any other university or Institution for the award of any degree or diploma.

  
A. Laxman  
Assistant Professor  
GUIDE

  
N. Ravi Kumar  
Assistant Professor  
CO-ORDINATOR

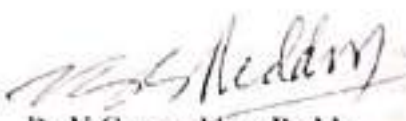
  
Dr. V. Gunasekhar Reddy  
Professor  
HOD OF DEPT. ECE



  
External Examiner

  
PRINCIPAL  
MAHAVEER





## Certificate

|                        |            |
|------------------------|------------|
| SILARI MANJESH         | 13E31A0449 |
| TELLABOINA UPENDAR RAO | 13E31A0451 |
| T SANJAY SINGH         | 13E31A0452 |
| UNDI SREEKANTH REDDY   | 13E31A0454 |
| VENNU RAVICHANDRA      | 13E31A0460 |

This is to certify that the above students of MAHAVEER INSTITUTE OF SCIENCE & TECHNOLOGY, Hyderabad, Studying B.Tech (E.C.E) final year, have completed their major projects with us on "CELLPHONE BASED VEHICLE REMOTE CONTROL SYSTEM" in the ECE Dept. Labs. For the partial fulfillment of the award of "Bachelor of Technology in E.C.E" During the period of 24th DEC 2016 to 2nd MAR 2017

For CONSCIENCE TECHNOLOGIES



Address  
R17-83/7C, 2nd Floor, Conscience Technologies  
Rangajouli Park, Hyderabad  
Dist. Khajuraho, Hyderabad  
© 2016 CONSCIENCE





## CERTIFICATE

This is to certify that the major project report work entitled "ZIGBEE SPY ROBOT USING WIRELESS WEBCAM" is submitted by

PRASHANT DWIVEDI  
R.KISHORE REDDY  
SILAIK ANEEFUDDIN  
S.SHIVA PRASAD

13E31A0444  
13E31A0445  
13E31A0447  
13E31A0448

In partial fulfilment of the requirements for the Degree of Bachelor of Technology in Electronics and Communication Engineering of Mahaveer Institute of Science and Technology, Hyderabad, during the academic year 2016-17, is a bonafide record of work carried out under our guidance and supervision.

The results embodied in this report have not been submitted to any other university or Institution for the award of any degree or diploma.

  
22/4/17  
S.Kirpal Kour  
Assistant Professor  
GUIDE

  
N.Raj Kumar  
Assistant Professor  
COORDINATOR

  
Dr.V.Gunasekhar Reddy  
Professor  
HEAD OF DEPT.

  
External Examiner



  
PRINCIPAL  
MAHAVEER





## Certificate

PRASHANT DWIVEDI

13E31A044

R. KISHORE REDDY

13E31A0445

SHAIK ANEEFUDDIN

13E31A0447

SIDDAM SHIVA PRASAD

13E31A0448

This is to certify that the above students of MAHAVEER INSTITUTE OF SCIENCE & TECHNOLOGY, Hyderabad, Studying B.Tech (E.C.E) final year, have completed their major projects with us on "ZIGBEE SPY ROBOT BY USING WIRELESS WEBCAM" in the ECE Dept. Labs. For the partial fulfillment of the award of "Bachelor of Technology in E.C.E" During the period of 24th DEC 2016 to 2nd MAR 2017

For CONSCIENCE TECHNOLOGIES

Project Manager

Y.S.REDDY

JR, HYD-60





## CERTIFICATE

This is to certify that the project work entitled "DEVELOPMENT OF AN AUTONOMOUS MICRO ROBOT FOR SWARM ROBOTICS" is submitted by

|                     |            |
|---------------------|------------|
| K.HARSHITH REDDY    | 13E31A0427 |
| M.RAJU              | 13E31A0436 |
| M.MAHESWARARA REDDY | 13E31A0437 |
| M.RAJENDER          | 13E31A0438 |
| Md.ANKOOS           | 13E31A0439 |
| M.SHWETHA           | 13E31A0441 |

in partial fulfillment of the requirements for the Degree of Bachelor of Technology in Electronics and Communication Engineering of Mahaveer Institute Of Science and Technology, Hyderabad, during the academic year 2016-17, is a bonafide record of work carried out under our guidance and supervision.

The results embodied in this report have not been submitted to any other university or Institution for the award of any degree or diploma.

  
**B.SUMITHRA REDDY**  
Assistant Professor  
GUIDE

  
**R.RAVI KUMAR**  
Assistant Professor  
COORDINATOR

  
**DR.V.GUNASEKHAR REDDY**  
Professor  
HEAD OF DEPT



  
External Examiner

  
PRINCIPAL  
MAHAVEER





## Certificate

|                           |            |
|---------------------------|------------|
| KONDAKINDI HARSHITH REDDY | 13E31A0427 |
| MANDHAPURAM RAJU          | 13E31A0436 |
| MAREDDY MAHESWARA REDDY   | 13E31A0437 |
| MODAVATH RAJENDER         | 13E31A0438 |
| MOHAMMED ANKOOS           | 13E31A0439 |
| MORAM SHWETHA             | 13E31A0441 |

This is to certify that the above students of MAHAVEER INSTITUTE OF SCIENCE & TECHNOLOGY, Hyderabad, Studying B.Tech (E.C.E) final year, have completed their minor project with us on "DEVELOPMENT OF AN AUTONOMOUS MICRO ROBOT FOR SWARM ROBOTICS" in the ECE Dept. Labs. For the partial fulfillment of the award of "Bachelor of Technology in E.C.E" During the period of 24th DEC 2016 to 2nd MAR 2017

For CONSCIENCE TECHNOLOGIES

Project Manager

Y.S. REDDY-60



Address

#17-83/2C, 3rd Floor, Opp. Bank of Maharashtra,  
Annapurna Function Hall Lane,  
Dilsuikinagar, Hyderabad-500011

*K. Srinivas*



Vysapuri, Bandlaguda Post:Keshavgiri,  
Hyderabad-500 005, TS, INDIA  
Tel: 040-20020772,20020773..Fax: 040-24455003  
E-mail: [e3hod.eco@gmail.com](mailto:e3hod.eco@gmail.com),  
Website: [www.mist.ac.in](http://www.mist.ac.in)

# MAHAVEER

INSTITUTE OF SCIENCE & TECHNOLOGY

Approved by AICTE, Affiliated to JNTUH,Hyd.



## CERTIFICATE

This is to certify that the project work entitled "SMART GREEN HOUSE-AUTOMATIC MONITORING AND CONTROL" is submitted by

|                            |   |            |
|----------------------------|---|------------|
| M.AKHIL KUMAR REDDY        | - | 13E31A0431 |
| MUDIGONDA SAMYUKTA         | - | 13E31A0432 |
| MAILARAM VISHAL            | - | 13E31A0433 |
| MALLELA HARINATH           | - | 13E31A0434 |
| MALLEM PARTHASARADHI REDDY | - | 13E31A0435 |

in partial fulfilment of the requirements for the Degree of Bachelor of Technology in *Electronics and Communication Engineering* of Mahaveer Institute Of Science and Technology, Hyderabad, during the academic year 2016-17, is a bonafide record of work carried out under our guidance and supervision.

The results embodied in this report have not been submitted to any other university or Institution for the award of any degree or diploma.

D. Sunitha  
Assistant Professor  
Guide

N. Ravi Kumar  
Assistant Professor  
Co-Ordinator

Dr. V. Gunasekhar Reddy  
Professor  
Head Of Dept.



External Examiner

PRINCIPAL  
MAHAVEER





## Certificate

|                            |            |
|----------------------------|------------|
| MAKHIL KUMAR REDDY         | 13E31A0431 |
| MUDIGONDA SAMYUKTA         | 13E31A0432 |
| MAILARAM VISHAL            | 13E31A0433 |
| MALLELA HARINATH           | 13E31A0434 |
| MALLEM PARTHASARADHI REDDY | 13E31A0435 |

This is to certify that the above students of MAHAVEER INSTITUTE OF SCIENCE & TECHNOLOGY, Hyderabad, Studying B.Tech (E.C.E) final year, have completed their major projects with us on "SMART GREEN HOUSE-AUTOMATIC MONITORING AND CONTROL" in the ECE Dept. Labs. For the partial fulfillment of the award of "Bachelor of Technology in E.C.E" During the period of 24th DEC 2016 to 2nd MAR 2017

For CONSCIENCE TECHNOLOGIES



Address  
#17-83/7C, 3rd Floor, Opp. Bank of Andhra, Annapurna Function Hall Lane, Dilu Ahnagar, Hyderabad-500 030.

PRINCIPAL  
MAHAVEER





## CERTIFICATE

This is to certify that the major project report work entitled "LIVE HUMAN DETECTION AND ALERTING ROBOT" is submitted by

A.ANUDEEP KUMAR  
A.KEERTHI PRIYA  
A.SRINIVASA RAO  
AKSHAY.R  
A.SUKUMAR

13E31A0401  
13E31A0402  
13E31A0405  
13E31A0406  
13E31A0407

in partial fulfillment of the requirements for the Degree of **Bachelor of Technology** in **Electronics and Communication Engineering** of Mahaveer Institute Of Science and Technology, Hyderabad, during the academic year 2016-17, is a bonafide record of work carried out under our guidance and supervision.

The results embodied in this report have not been submitted to any other university or Institution for the award of any degree or diploma.

**D. Lakshmi Narayana**  
Associate Professor  
Guide

**N. Ravi Kumar**  
Assistant Professor  
Coordinator

**Dr. V. Gunasekhar Reddy**  
Professor  
Head of Dept.



**External Examiner**

**PRINCIPAL**  
**MAHAVEER**





## Certificate

A.ANUDEEP KUMAR

13E31A0401

A.KEERTHY PRIYA

13E31A0402

AJMEERA SRINIVASA RAO

13E31A0405

AKSHAY R

13E31A0406

ANABATHULA SUKUMAR

13E31A0407

This is to certify that the above students of MAHAVEER INSTITUTE OF SCIENCE & TECHNOLOGY, Hyderabad, Studying B.Tech (E.C.E) final year, have completed their major projects with us on "LIVE HUMAN DETECTION AND ALERTING ROBOT" in the ECE Dept. Labs.

For the partial fulfillment of the award of "Bachelor of Technology in ECE"  
During the period of 24th DEC 2016 to 2nd MAR 2017

For CONSCIENCE TECHNOLOGIES



Address

#17-83/2C, 3rd Floor, Opp. Park of Maharashtra,

Annapurna Function Hall

Disukh Nagar, Hyderabad-500005

☎ : 040-6012 1199





## CERTIFICATE

This is to certify that the project work entitled "POWER SAVING FOR HIGHWAY AND ACCIDENT AVOIDANCE WITH WARNING SYSTEM" is submitted by

|                 |            |
|-----------------|------------|
| G.MANASA        | 13E31A0419 |
| K.RUPA          | 13E31A0426 |
| K.NAGESHWAR RAO | 13E31A0428 |
| K.SWAPNA        | 13E31A0429 |
| L.DIVYA         | 13E31A0430 |

in partial fulfillment of the requirements for the Degree of Bachelor of Technology in Electronics and Communication Engineering of Mahaveer Institute Of Science and Technology, Hyderabad, during the academic year 2016-17, is a bonafide record of work carried out under our guidance and supervision.

The results embodied in this report have not been submitted to any other university or Institution for the award of any degree or diploma.

  
CH. Sunderp Kumar  
Assistant Professor  
GUIDE

  
N. Ravi Kumar  
Assistant Professor  
Co-ordinator

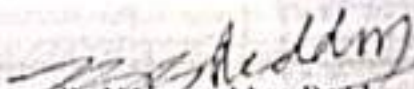
  
Dr. V. Gunasekhar Reddy  
Professor  
Head of the Dept.

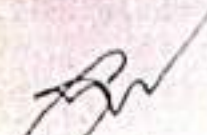

  
External Examiner

  
PRINCIPAL









## CERTIFICATE

This is to certify that the project work entitled " VOICE GUIDANCE BASED GPS TURN BY TURN NAVIGATION FOR BLIND VISION IMPAIRED PEOPLE " is submitted by

|                   |            |
|-------------------|------------|
| J.HEMANTH CHANDRA | 13E31A0421 |
| K.MANI KUMAR      | 13E31A0423 |
| K.RISHIKKANTH     | 13E31A0424 |
| K.NIKIL REDDY     | 13E31A0425 |

in partial fulfillment of the requirements for the Degree of Bachelor of Technology in Electronics and Communication Engineering of Mahaveer Institute Of Science and Technology, Hyderabad, during the academic year 2016-17, is a bonafide record of work carried out under our guidance and supervision.

The results embodied in this report have not been submitted to any other university or Institution for the award of any degree or diploma.

  
M.K.Khan  
Asst.Professor  
GUIDE

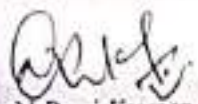
  
N.Ravi Kumar  
Asst. Professor  
CO-ORDINATOR

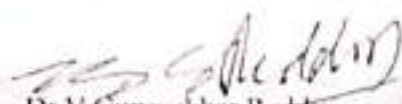
  
Dr.V.Gunasekhar Reddy  
Professor  
HEAD OF DEPT.



  
External Examiner

  
PRINCIPAL  
MAHAVEER



# Certificate

|                     |            |
|---------------------|------------|
| J. HEMANTH CHANDRA  | 13E31A0421 |
| KESANA MANI KUMAR   | 13E31A0423 |
| KANTAM RISHIK KANTH | 13E31A0424 |
| K. NIKIL REDDY      | 13E31A0425 |

This is to certify that the above students of **MAHAVEER INSTITUTE OF SCIENCE & TECHNOLOGY, Hyderabad, Studying B.Tech (E.C.E) final year**, have completed their major project with us on **"VOICE GUIDENCE BASED GPS TURN BY TURN NAVIGATION FOR BLIND VISION IMPAIRED PEOPLE"** in the ECE Dept. Labs. For the partial fulfillment of the award of "Bachelor of Technology in E.C.E" During the period of 24th DEC 2016 to 2nd MAR 2017



Address:  
6/17-83/2C, 8th Floor, Opp. Mahadevi, Annapurna Function  
Dilsuffnagan, Hyderabad-500004  
☎ 040-6012 1199

MAHAVEER



sapuri, Bandlaguda Post:Keshavgiri,  
derabad-500 005, TS, INDIA  
E: 040-20020772,20020773, Fax: 040-24455003  
mail: e3hod.ece@gmail.com,  
hsite: www.mist.ac.in

# MAHAVEER

INSTITUTE OF SCIENCE & TECHNOLOGY  
Approved by AICTE, Affiliated to JNTU(H) Hyd



## CERTIFICATE

This is to certify that the project work entitled "IMPLEMENTATION OF ADVANCED SECURITY SYSTEM FOR FINDING THE HELMET AND ALCOHOL STATUS OF TWO WHEELER VEHICLES" is submitted by

|                         |            |
|-------------------------|------------|
| EPPALAPALLI SHIVA KUMAR | 13E31A0414 |
| G.SAI DEEPTHI           | 13E31A0415 |
| G.SAI SWAGATH           | 13E31A0416 |
| GADDI SAI KRISHNA       | 13E31A0417 |
| GAJULA SATISH KUMAR     | 13E31A0418 |

in partial fulfillment of the requirements for the Degree of Bachelor of Technology in Electronics and Communication Engineering of Mahaveer Institute Of Science and Technology, Hyderabad, during the academic year 2016-17, is a bonafide record of work carried out under our guidance and supervision.

The results embodied in this report have not been submitted to any other university or Institution for the award of any degree or diploma.

N. Ravi Kumar  
Assistant Professor  
GUIDE

N. Ravi Kumar  
Assistant Professor  
CO-ORDINATOR

Dr. V. Gunasekhar Reddy  
Professor  
HOD OF DEPT.ECE



External Examiner

PRINCIPAL  
MAHAVEER

INSTITUTE OF SCIENCE & TECHNOLOGY

Bandlaguda Post, Keshavgiri, Hyd-500 005.





## Certificate

EPPALAPALLI SHIVA KUMAR

13E31A0414

G. SAI DEEPTHI

13E31A0415

G. SAISWAGATHI

13E31A0416

GADDI SAI KRISHNA

13E31A0417

GAJULA SATISH KUMAR

13E31A0418

This is to certify that the above students of MAHAVEER INSTITUTE OF SCIENCE & TECHNOLOGY, Hyderabad, Studying B.Tech (E.C.E) final year, have completed their major projects with us on "IMPLEMENTATION OF ADVANCE SECURITY SYSTEM FOR FINDING HELMET AND ALCOHOL STATUS OF TWO WHEELER VEHICLES" in the ECE Dept. Labs. For the partial fulfillment of the award of "Bachelor of Technology in E.C.E" During the period of 24th DEC 2016 to 2nd MAR 2017

For CONSCIENCE TECHNOLOGIES



Address:

417-83/2C, 3rd Floor, Opp. Bunt of M. Marudhira,

Annapurna Function Hall, 11th,

Dilsukhnagar, Hyderabad-500 045

☎ : 040-6012 1199





## CERTIFICATE

This is to certify that the major project report work entitled "WIRELESS TRACKING SYSTEM MEDICAL EQUIPMENT" is submitted by

|                  |            |
|------------------|------------|
| B.PRANEETH KUMAR | 13E31A0409 |
| CHERUKU BIARATHI | 13E31A0410 |
| CH.PRUDHVI RAJ   | 13E31A0411 |
| CH.RAJESH KUMAR  | 13E31A0412 |
| D.SAI CHARAN     | 13E31A0413 |

in partial fulfillment of the requirements for the Degree of Bachelor of Technology in Electronics and Communication Engineering of Mahaveer Institute Of Science and Technology, Hyderabad, during the academic year 2016-17, is a bonafide record of work carried out under our guidance and supervision.

The results embodied in this report have not been submitted to any other university or Institution for the award of any degree or diploma.

  
M.Chenna  
Assistant Professor  
Guide

  
N.Ravi Kumar  
Assistant Professor  
Coordinator

  
Dr.V.Gunasekhar Reddy  
Professor  
Head of Dept.



  
External Examiner

  
PRINCIPAL  
MAHAVEER



## Certificate

EATTU PRANEETH KUMAR

13E31A0409

CHERUKU BHARATHI

13E31A0410

CHINTHANABOYINA PRUDHVI RAJ

13E31A0411

CHITUPROLU RAJESH KUMAR

13E31A0412

DASARI SAICHARAN

13E31A0413

This is to certify that the above students of MAHA VEER INSTITUTE OF SCIENCE & TECHNOLOGY, Hyderabad, Studying B.Tech (E.C.E) final year, have completed their major projects with us on "WIRELESS TRACKING SYSTEM MEDICAL EQUIPMENT" in the ECE Dept. Labs. For the partial fulfillment of the award of "Bachelor of Technology in E.C.E" During the period of 24th DEC 2010 to and 31st Feb 2011

For CONSCIENCE TECHNOLOGIES



Address

#17-83/2C, 3rd Floor, Opp. Bank of Maharashtra,  
Annapurna Fuel Station, 4th Lane,  
Dilsukhnagar, Hyderabad-500060



**MAHAVEER INSTITUTE OF SCIENCE & TECHNOLOGY**  
(Affiliated to JNTU Hyderabad, Approved by AICTE)  
Vyasapuri, Bandlaguda, Post - Keshavgiri, Hyderabad-500005



**CERTIFICATE**

This is to certify that the Industry Oriented Main Project work report entitled **"Detecting Stress based on Social Interactions in Social Networks"** which is being submitted by **L. Devi [14E31A0529], Neha Samreen [14E31A0538], K. Sai Sangeetha [14E31A0528]** in partial fulfilment for the award of the Degree of **BACHELOR OF TECHNOLOGY** in **COMPUTER SCIENCE AND ENGINEERING** of **JAWAHARLAL NEHRU TECHNOLOGICAL UNIVERSITY HYDERABAD**, is a record of the bonafide work carried out by them under our guidance and supervision.

  
**Mrs. M. Sonia**  
Asst. Professor

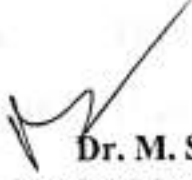
  
**Dr. M. Suresh**  
Head Of the Department

  
External Examiner

**Dr. K. S. S. S. Reddy**  
Principal

**PRINCIPAL**  
**MAHAVEER**  
INSTITUTE OF SCIENCE & TECHNOLOGY  
Bandlaguda, Hyd-500 005.

# MAHAVEER INSTITUTE OF SCIENCE AND TECHNOLOGY

(Affiliated to JNTU Hyderabad, Approved by AICTE)  
Vyasapuri, Bandlaguda, Post: Keshavgiri, Hyderabad-500005



## CERTIFICATE

This is to certify that the industry oriented major project report entitled “**Re-Ranking of images based on topic diversity**” which is being submitted by **A.Pranay Reddy [14E31A0508]**, **M.A.Mujadid Mohiuddin [14E31A0530]**, **Vijay Ojha [14E31A0558]**, **Y. Raj Kumar [14E31A0560]** in partial fulfilment for the award of the Degree of **BACHELOR OF TECHNOLOGY** in **COMPUTER SCIENCE AND ENGINEERING** of **JAWAHARLAL NEHRU TECHNOLOGICAL UNIVERSITY**, is a record of the bona fide work carried out by them under our guidance and supervision.

  
**Mr.K.Sudhakar**

Project guide

  
**DR.M.Suresh**

Head of department

  
**External Examiner**

**Dr. K. S. S. S.N. Reddy**  
Principal

**PRINCIPAL**  
**MAHAVEER**  
**INSTITUTE OF SCIENCE & TECHNOLOGY**  
Bandlaguda, Hyd-500 005.



**MAHAVEER INSTITUTE OF SCIENCE & TECHNOLOGY**  
(Affiliated to JNTU Hyderabad, Approved by AICTE)  
Vyasapuri, Bandlaguda, Post: Keshavgiri, Hyderabad-500005



**CERTIFICATE**

This is to certify that the industry oriented major project work report entitled **“Privacy Preserving Utility Verification of Data Published by Non Interactive Differentially Private Mechanism”** Which is being submitted by Saba Samreen [14E31A0547], G.Roja Rani [14E31A0523], Akhilendra Alle [14E31A0504], Jaipal Dongre [14E31A0513] in partial fulfillment for the award of the Degree of **BACHELOR OF TECHNOLOGY** in **COMPUTER SCIENCE AND ENGINEERING** of **JAWAHARLAL NEHRU TECHNOLOGY UNIVERSITY**, is a record of the bona fide work carried out by them under our guidance and supervision.

  
Mrs. M. Srividya  
Project guide

  
External Examiner

  
Dr. M. Suresh  
Head Of The Department

**PRINCIPAL**  
**MAHAVEER**  
INSTITUTE OF SCIENCE & TECHNOLOGY  
Bandlaguda, Hyd-500 005.

**Dr. K. S. S. S. N. Reddy**  
Principal

# MAHAVEER INSTITUTE OF SCIENCE & TECHNOLOGY

(Affiliated to JNTU Hyderabad, Approved by AICTE)

Vyasapuri, Bandlaguda, Post: Keshavgiri, Hyderabad-500005



## CERTIFICATE

This is to certify that the major project report entitled "Soci Rank: Identifying and Ranking Prevalent news topics using Social Media" which is being submitted by **Ch.Aishwarya[14E31A0511]**, **K.Sankirth[14E31A05327]**, **P.Srilatha [14E31A0543]**, **V. Sai Teja [14E31A0559]** in partial fulfilment for the award of the Degree of **BACHELOR OF TECHNOLOGY** in **COMPUTER SCIENCE & ENGINEERING** of **JAWAHARLAL NEHRU TECHNOLOGICAL UNIVERSITY**, is a record of the bona fide work carried out by them under our guidance and supervision.

Mr. K. Kiran

Assist. prof, CSE Dept

Dr. M. Suresh

Head of the Department

External Examiner

Dr. K. S. S. N. Reddy  
Principal

PRINCIPAL  
MAHAVEER  
INSTITUTE OF SCIENCE & TECHNOLOGY  
Bandlaguda, Hyd-500 005.



# MAHAVEER INSTITUTE OF SCIENCE & TECHNOLOGY

(Affiliated to JNTU Hyderabad, Approved by AICTE)  
Vyasapuri, Bandlaguda, Post: Keshavgi, Hyderabad-500005



## CERTIFICATE

This is to certify that the industry oriented major project work report entitled "Connecting Social Media To E-commerce : Cold Start Product Recommendation Using Microblogging Information" which is being submitted by A.Niharika [14E31A0503], S.Naga Nikhil [14E31A0546], Vanga Prashanth [14E31A0555] in partial fulfilment for the award of the Degree of BACHELOR OF TECHNOLOGY in COMPUTER SCIENCE AND ENGINEERING of JAWAHARLAL NEHRU TECHNOLOGICAL UNIVERSITY, is a record of the bona fide work carried out by them under our guidance and supervision.

MS.D.Anusha Reddy  
Assistant Professor

Dr.M.Suresh  
Head Of the Department

External Examiner

Dr. K. S. S. S. N. Reddy  
Principal

PRINCIPAL  
MAHAVEER  
INSTITUTE OF SCIENCE & TECHNOLOGY  
Bandlaguda, Hyd-500 005.

# MAHAVEER INSTITUTE OF SCIENCE AND TECHNOLOGY

(Affiliated to JNTU Hyderabad, Approved by AICTE)  
Vyasapuri, Bandlaguda, Post: Keshavagiri, Hyderabad-500005



## CERTIFICATE

This is to certify that the industry oriented major project work report entitled "AN EFFICIENT AND FINE-GRAINED BIG-DATA ACCESS CONTROL SCHEME WITH PRIVACY PRESERVING POLICY" which is being submitted by S.Sruthi[14E31A0551] S.Yogesh [14E31A0552] T.Chandrika [14E31A0553] in partial fulfilment for the award of the Degree of BACHELOR OF TECHNOLOGY in COMPUTER SCIENCE AND ENGINEERING of JAWAHARLAL NEHRU TECHNOLOGICAL UNIVERSITY, is a record of the bonafide work carried out by them under our guidance and supervision.

  
Mr. E. Rajesh

  
Prof. Dr. M. Suresh

HEAD OF THE DEPARTMENT

  
External Examiner

  
Dr. K. S. S. S. N. REDDY  
Principle

**PRINCIPAL**  
**MAHAVEER**  
INSTITUTE OF SCIENCE & TECHNOLOGY  
Bandlaguda, Hyd-500 005.



# MAHAVEER INSTITUTE OF SCIENCE AND TECHNOLOGY

(Affiliated to JNTU Hyderabad, Approved by AICTE)  
Vyasapuri, Bandlaguda, Post: Keshavgiri, Hyderabad-500005



## CERTIFICATE

This is to certify that the industry oriented mini project work report entitled **“FILTERING OUT INFREQUENT BEHAVIOUR FROM BUSINESS PROCESS EVENT LOGS”** which is being submitted by **G.Karuna Sagar [14E31A0518], KhushbhuDongare[14E31A0526], M.Shivajyothi[14E31A0535], P. Santosh Kumar[14E31A0542]** in partial fulfilment for the award of the Degree of **BACHELOR OF TECHNOLOGY** in **COMPUTER SCIENCE AND ENGINEERING** of **JAWAHARLAL NEHRU TECHNOLOGICAL UNIVERSITY**, is a record of the bona fide work carried out by them under our guidance and supervision.

**Mrs. P. Vigneshwari**

Assistant Professor

External examiner

  
**Prof.M.SURESH**

[ Head of the department ]

PRINCIPAL

DR.K.S.S.S.N.REDDY

PRINCIPAL  
MAHAVEER  
INSTITUTE OF SCIENCE & TECHNOLOGY  
Bandlaguda, Hyd-500 005.

# MAHAVEER INSTITUTE OF SCIENCE & TECHNOLOGY

(Affiliated to JNTU Hyderabad, Approved by AICTE)

Vyasapuri, Bandlaguda, Post: Keshavgiri, Hyderabad-500005



## CERTIFICATE

This is to certify that the major project report entitled “**Enabling Cloud Storage Auditing With Verifiable Outsourcing of Key Updates**” which is being submitted by **Amir sohail [14E31A0505]** **Rahul Kumar [14E31A0544]**, **V.Sairam [14E31A0557]**, **Saleha Begum [14E31A0548]** in partial fulfilment for the award of the Degree of **BACHELOR OF TECHNOLOGY** in **COMPUTER SCIENCE & ENGINEERING** of **JAWAHARLAL NEHRU TECHNOLOGICAL UNIVERSITY**, is a record of the bona fide work carried out by them under our guidance and supervision.

Mrs.D.Srilatha Reddy

Assist. prof, CSE Dept

Dr .M.Suresh

Head of the Department

External Examiner

Dr. K. S. S. S. N. Reddy  
Principal

PRINCIPAL  
MAHAVEER  
INSTITUTE OF SCIENCE & TECHNOLOGY  
Bandlaguda, Hyd-500 005.



# MAHAVEER INSTITUTE OF SCIENCE & TECHNOLOGY

(Affiliated to JNTU Hyderabad, Approved by AICTE)  
Vyasapuri, Bandlaguda, Post: Keshavgi, Hyderabad-500005

2017-2018

# MAHAVEER INSTITUTE OF SCIENCE & TECHNOLOGY

(Affiliated to JNTU Hyderabad, Approved by AICTE)  
Vyasapuri, Bandlaguda, Post: Keshavgi, Hyderabad-500005



## CERTIFICATE

This is to certify that the industry oriented mini project work report entitled "User Vitality Ranking and Prediction in Social Networking Services: A Dynamic Network Perspective" which is being submitted by GILLA RAJESH [14E31A0520], G SAI NISHANTH REDDY [14E31A0522], I KISHOR NAYAK [14E31A0524], G SRINIVAS [14E31A0517] in partial fulfilment for the award of the Degree of BACHELOR OF TECHNOLOGY in COMPUTER SCIENCE AND ENGINEERING of JAWAHARLAL NEHRU TECHNOLOGICAL UNIVERSITY, is a record of the bonafide work carried out by them under our guidance and supervision.

  
Mr. A. SHIVA KUMAR  
Asst. Professor

  
Dr. M Suresh  
Head of the Department

  
External Examiner

**PRINCIPAL**  
**MAHAVEER**  
INSTITUTE OF SCIENCE & TECHNOLOGY  
Bandlaguda, Hyd-500 005.

  
Dr. K. S. S. S. N. REDDY  
Principal

**MAHAVEER INSTITUTE OF SCIENCE & TECHNOLOGY**  
(Affiliated to JNTU Hyderabad, Approved by AICTE)  
Vyasapuri, Bandlaguda, Post: Keshavgi, Hyderabad-500005



**CERTIFICATE**

This is to certify that the major project report entitled “Towards Real-Time, Country-Level Location Classification of Worldwide Tweets” which is being submitted by E.Anupriya [14E31A0514] M.Nithin [14E31A0533], T.Anusha [14E31A0554], V. Sreekanth [14E31A0556] in partial fulfilment for the award of the Degree of BACHELOR OF TECHNOLOGY in COMPUTER SCIENCE & ENGINEERING of JAWAHARLAL NEHRU TECHNOLOGICAL UNIVERSITY, is a record of the bona fide work carried out by them under our guidance and supervision.

  
Mr. M. Sreenivas Reddy  
Assist. prof, CSE Dept

  
External Examiner

  
Dr. M. Suresh  
Head of the Department

  
Dr. K. S. S. N. Reddy  
Principal

**PRINCIPAL**  
**MAHAVEER**  
INSTITUTE OF SCIENCE & TECHNOLOGY  
Bandlaguda, Hyd-500 005.



**MAHAVEER INSTITUTE OF SCIENCE & TECHNOLOGY**

(Affiliated to JNTU Hyderabad, Approved by AICTE)

Vyasapuri, Bandlaguda, Post: Keshavgiri, Hyderabad-500005

2017-2018



**CERTIFICATE**

This is to certify that the major project work report entitled "EFFICIENT CACHE SUPPORTED PATH PLANNING ON ROADS" which is being submitted by A.V ABHISHEK [14E31A0507], G.DHRUVA MANASA [14E31A0519], Y.SAHITHI [14E31A0521], M.MANISHA [14E31A0536] in partial fulfilment for the award of the Degree of BACHELOR OF TECHNOLOGY in COMPUTER SCIENCE & ENGINEERING of JAWAHARLAL NEHRU TECHNOLOGICAL UNIVERSITY, is a record of the bonafide work carried out by them under our guidance and supervision.

Mr. T.R SRINIVAS

ASSOCIATE PROFESSOR

GUIDE

Dr. M. SURESH

HEAD OF DEPARTMENT

EXTERNAL EXAMINAR

Dr. K. S. S. N. REDDY

PRINCIPAL

**PRINCIPAL  
MAHAVEER  
INSTITUTE OF SCIENCE & TECHNOLOGY  
Bandlaguda, Hyd-500 005.**

# MAHAVEER INSTITUTE OF SCIENCE & TECHNOLOGY

(Affiliated to JNTU Hyderabad, Approved by AICTE)  
Vyasapuri, Bandlaguda, Post: Keshavgiri, Hyderabad-500005



## CERTIFICATE

This is to certify that the industry oriented mini project work report entitled "FOLLOW BUT NO TRACK PRIVACY PRESERVED PROFILE PUBLISHING IN CYBER PHYSICAL SOCIAL SYSTEM" which is being submitted by A.VISHNU PREETH REDDY [14E31A0501], A.RASAGNYA REDDY [14E31A0502], N.PAVAN [14E31A0537], P.RAMYA [14E31A0541] in partial fulfilment for the award of the Degree of BACHELOR OF TECHNOLOGY in COMPUTER SCIENCE AND ENGINEERING of JAWAHARLAL NEHRU TECHNOLOGICAL UNIVERSITY, is a record of the bona fide work carried out by them under our guidance and supervision.

  
Mr. K.T.SRINIVASA RAO  
Professor

  
External Examiner

  
Dr. M.SURESH  
HEAD OF THE DEPARTMENT

  
Dr. K. S. S. S. REDDY  
PRINCIPAL

PRINCIPAL  
**MAHAVEER**  
INSTITUTE OF SCIENCE & TECHNOLOGY  
Bandlaguda, Hyd-500 005.



# MAHAVEER INSTITUTE OF SCIENCE AND TECHNOLOGY

(Affiliated to JNTU Hyderabad, Approved by AICTE)  
Vyasapuri, Bandlaguda, Post: Keshavgiri, Hyderabad-500005



## CERTIFICATE

This is to certify that the industry oriented major project work report entitled “**Inference Attack on Browsing History of Twitter Users using Public Click Analytics and Twitter Metadata**” which is being submitted by **V.Kranthi Kumar [14E31A05B3], P. Sai Amruth Raj [14E31A0599], K.Ninusha [14E31A0585], M.Sai Kiran Goud [14E31A05A4]** in partial fulfilment for the award of the Degree of **BACHELOR OF TECHNOLOGY** in **COMPUTER SCIENCE AND ENGINEERING** of **JAWAHARLAL NEHRU TECHNOLOGICAL UNIVERSITY**, is a record of the bonafide work carried out by them under our guidance and supervision.

  
Mrs.J.Madhavi

PROJECT GUIDE



DR.M.SURESH

HEAD OF THE DEPARTMENT

  
External Examiner

  
Dr. K. S. S. S. N. REDDY  
PRINCIPAL

PRINCIPAL  
MAHAVEER  
INSTITUTE OF SCIENCE & TECHNOLOGY  
Bandlaguda, Hyd-500 005.



# MAHAVEER INSTITUTE OF SCIENCE AND TECHNOLOGY

(Affiliated to JNTU Hyderabad, Approved by AICTE)

Vyasapuri, Bandlaguda, Post: Keshavgiri, Hyderabad-500005



## CERTIFICATE

This is to certify that project work report entitled "Rapere: A GENERIC STRATEGY FOR COLD-START RATING PREDICTION PROBLEM" which is being submitted by D.Vishal Reddy [14E31A0572], B.Shruthi, [14E31A0568], U. Santosh [14E31A05B2], in partial fulfilment of the requirements for the award of the Degree of BACHELOR OF TECHNOLOGY in COMPUTER SCIENCE AND ENGINEERING of JAWAHARLAL NEHRU TECHNOLOGICAL UNIVERSITY, is a record of the bonafide work carried out by them under our guidance and supervision.

  
Mr.P.Solmon

Project Guide

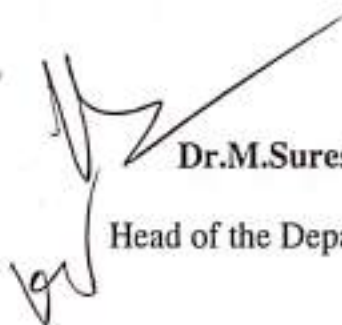
  
Dr.M.Suresh  
Head of the Department

  
External Examiner

  
Dr. K. S. S. S.N. Reddy

PRINCIPAL  
MAHAVEER  
INSTITUTE OF SCIENCE & TECHNOLOGY  
Bandlaguda, Hyd-500 999:

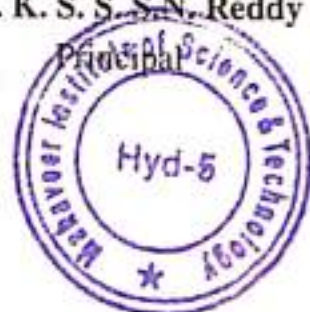



# MAHAVEER INSTITUTE OF SCIENCE & TECHNOLOGY

(Affiliated to JNTU Hyderabad, Approved by AICTE)  
Vyasapuri, Bandlaguda, Post: Keshavgi, Hyderabad-500005



## CERTIFICATE

This is to certify that the industry oriented major project work report entitled "COLLABORATIVE FILTERING-BASED RECOMMENDATION OF ONLINE SOCIAL VOTING" which is being submitted by **A.David [14E31A0563]**, **E.Manasa [14E31A0575]**, **G.RachelChristabell [14E31A0578]**, **G.Anil Kumar [14E31A05B6]** in partial fulfilment for the award of the Degree of **BACHELOR OF TECHNOLOGY** in **COMPUTER SCIENCE AND ENGINEERING** of **JAWAHARLAL NEHRU TECHNOLOGICAL UNIVERSITY**, is a record of the bona fide work carried out by them under our guidance and supervision.

Mr.B.SevaNaik

PROJECT GUIDE

Dr.M.SURESH

HEAD OF THE DEPARTMENT

External Examiner

Dr. K. S. S. N. REDDY

PRINCIPAL  
MAHAVEER  
INSTITUTE OF SCIENCE & TECHNOLOGY  
Bandlaguda, Hyd-500 005.



# MAHAVEER INSTITUTE OF SCIENCE & TECHNOLOGY

(Affiliated to JNTU Hyderabad, Approved by AICTE)  
Vyasapuri, Bandlaguda, Post: Keshavgi, Hyderabad-500005



## CERTIFICATE

This is to certify that the industry oriented mini project work report entitled “Social Q&A:An online social network based question and answer system” which is being submitted by

|            |              |
|------------|--------------|
| S.DIVYA    | [14E31A05B8] |
| A.LIKHITHA | [14E31A0564] |
| M.SUBHAVAN | [14UJ1A0519] |
| M.HARISH   | [14E31A0589] |

in partial fulfilment for the award of the Degree of **BACHELOR OF TECHNOLOGY** in **COMPUTER SCIENCE AND ENGINEERING** of **JAWAHARLAL NEHRU TECHNOLOGICAL UNIVERSITY**, is a record of the bonafide work carried out by them under our guidance and supervision.

  
Mr. MUNEER AHMED  
Associate Professor

  
External Examiner

PRINCIPAL  
MAHAVEER  
INSTITUTE OF SCIENCE & TECHNOLOGY  
Bandlaguda, Hyd-500 005.

  
DR. M. SURESH  
Head of the Department

  
Dr. K. S. S. S. N. REDDY  
PRINCIPAL





# MAHAVEER INSTITUTE OF SCIENCE AND TECHNOLOGY

(Affiliated to JNTU Hyderabad, Approved by AICTE)  
Vyasapuri, Bandlaguda, Post: Keshavgiri, Hyderabad-500005



## CERTIFICATE

This is to certify that the project report entitled "IPATH-PATH INFERENCE IN WIRELESS SENSOR NETWORKS" which is being submitted by D.Amar [14E31A0573], P.Abhishek Reddy [14E31A05A1], T.Alekya [14E31A05B1], B.Sai Krishna [13E31A05C3] in partial fulfilment for the award of the Degree of BACHELOR OF TECHNOLOGY in COMPUTER SCIENCE AND ENGINEERING of JAWAHARLAL NEHRU TECHNOLOGICAL UNIVERSITY, is a record of the bonafide work carried out by them under our guidance and supervision.

  
Mrs.M.Sarojini Rani  
PROJECT GUIDE

  
Prof. DR. M. SURESH  
HEAD OF THE DEPARTMENT

  
External Examiner

PRINCIPAL  
**MAHAVEER**  
INSTITUTE OF SCIENCE & TECHNOLOGY  
Bandlaguda, Hyd-500 005.

  
Dr. K. S. S. S. N. REDDY  
PRINCIPAL

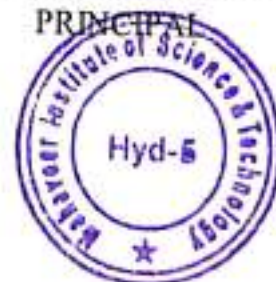

# MAHAVEER INSTITUTE OF SCIENCE AND TECHNOLOGY

(Affiliated to JNTU Hyderabad, Approved by AICTE)  
Vyasapuri, Bandlaguda, Post: Keshavgi, Hyderabad-500005



## CERTIFICATE

This is to certify that the major project work report entitled "A PROXY BASED COLLABORATION SYSTEM TO MINIMIZE CONTENT DOWNLOAD TIME AND ENERGY CONSUMPTION EXPLANATION " which is being submitted by M.Sirilesh kumar [14E31A0590], M.P.Akhil [14E31A0596], P.Kalyan reddy [14E31A05A0], K.Bhargavi [14E31A0586] in partial fulfilment for the award of the Degree of BACHELOR OF TECHNOLOGY in COMPUTER SCIENCE AND ENGINEERING of JAWAHARLAL NEHRU TECHNOLOGICAL UNIVERSITY, is a record of the bonafide work carried out by them under our guidance and supervision.

**Mrs. RAJINI PARIMALA**  
Project guide

**Dr.M. Suresh**  
HEAD OF THE DEPARTMENT

PRINCIPAL  
MAHAVEER  
INSTITUTE OF SCIENCE & TECHNOLOGY  
Bandlaguda, Hyd-500 005.

**External Examiner**

**Dr. K. S. S. S.N. REDDY**  
PRINCIPAL





# MAHAVEER INSTITUTE OF SCIENCE AND TECHNOLOGY

(Affiliated to JNTU Hyderabad, Approved by AICTE)  
Vyasapuri, Bandlaguda, Post: Keshavgi, Hyderabad-500005



## CERTIFICATE

This is to certify that the industry oriented major project work report entitled "ATTRIBUTE BASED STORAGE SUPPORTING SECURE DE-DUPLICATION OF ENCRYPTED DATA IN CLOUD" which is being submitted by S.Sirisowmya (14E31A05A6), D. Shravan Goud (14E31A0574) G. Sai Kishore (14E31A0582), S. Hari Kumar (14E31A05A8) in partial fulfilment for the award of the Degree of BACHELOR OF TECHNOLOGY in COMPUTER SCIENCE AND ENGINEERING of JAWAHARLAL NEHRU TECHNOLOGICAL UNIVERSITY, is a record of the bonafide work carried out by them under our guidance and supervision.

  
Dr. M. Suresh

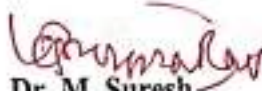
  
Dr. M. Suresh  
HEAD OF THE DEPARTMENT

  
External Examiner

PRINCIPAL  
MAHAVEER  
INSTITUTE OF SCIENCE & TECHNOLOGY  
Bandlaguda, Hyd-500 005.

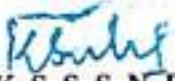
  
Dr. K. S. S. N. REDDY



# MAHAVEER INSTITUTE OF SCIENCE AND TECHNOLOGY

(Affiliated to JNTU Hyderabad, Approved by AICTE)  
Vyasapuri, Bandlaguda, Post: Keshavgi, Hyderabad-500005



## CERTIFICATE

This is to certify that the industry oriented major project work report entitled "Search Rank Fraud and Malware Detection in Google Play" which is being submitted by A.Anirudh Reddy [14E31A0562], M.Raghavendra [14E31A0591], N.Mounika [14E31A0577], R.Manisha [14E31A05A3] in partial fulfilment for the award of the Degree of BACHELOR OF TECHNOLOGY in COMPUTER SCIENCE AND ENGINEERING of JAWAHARLAL NEHRU TECHNOLOGICAL UNIVERSITY, is a record of the bonafide work carried out by them under our guidance and supervision.

  
Mr. K. Giti Babu

PROJECT GUIDE

  
DR. M. SURESH

  
HEAD OF THE DEPARTMENT

  
External Examiner

  
Dr. K. S. S. N. REDDY

PRINCIPAL

PRINCIPAL  
MAHAVEER  
INSTITUTE OF SCIENCE & TECHNOLOGY  
Bandlaguda, Hyd-500 005.





# MAHAVEER INSTITUTE OF SCIENCE AND TECHNOLOGY

(Affiliated to JNTU Hyderabad, Approved by AICTE)  
Vyasapuri, Bandlaguda, Post: Keshavgiri, Hyderabad-500005



## CERTIFICATE

This is to certify that the major project work report entitled "SWEET: SERVING the WEB by EXPLOITING EMAIL TUNNELS" which is being submitted by Shradha Ojha [14E31A05A7], Syeda Sadiyah Tasneem [14E31A05B0], E.Vamshidhar [14E31A0576], G.Sai Chakradhar [14E31A0580] in partial fulfilment for the award of the Degree of BACHELOR OF TECHNOLOGY in COMPUTER SCIENCE AND ENGINEERING of JAWAHARLAL NEHRU TECHNOLOGICAL UNIVERSITY, is a record of the bonafide work carried out by them under our guidance and supervision.

  
Mrs. Manasa  
Project guide

  
Dr. M. Suresh  
HEAD OF THE DEPARTMENT

  
External Examiner

  
Dr. K. S. S. S. N. REDDY

PRINCIPAL  
MAHAVEER  
INSTITUTE OF SCIENCE & TECHNOLOGY  
Bandlaguda, Hyd-500 005.





## CERTIFICATE

This is to certify that this project report entitled "A Distributed Publisher-Driven Secure Data Sharing Scheme for Information-Centric IoT" which is submitted by Munazza Fatima [14E31A0595], Syed Waseem [14E31A05A9], Shreya Mayuri [14E31A05B7], CH.Sai Vamshi Krishna [13E31A0515] in partial fulfillment for the award of Bachelor of Technology Degree in Computer Science and Engineering department of Mahaveer Institute of Science and Technology, affiliated to Jawaharlal Nehru Technological University, Hyderabad and is a bonafide record of work carried out by them under our guidance during 2017-2018.

Signature of Project Guide  
Mr. K. Sudhakar

Signature of Head of Department  
Dr. M. Suresh

External Examiner

Dr.K.S.S.S.N. REDDY  
(Principal)

PRINCIPAL  
MAHAVEER  
INSTITUTE OF SCIENCE & TECHNOLOGY  
Sundaraguda, Hyd-500 005..





# MAHAVEER INSTITUTE OF SCIENCE & TECHNOLOGY

(Affiliated to JNTU Hyderabad, Approved by AICTE)

Vyasapuri, Bandlaguda, Post - Keshavgiri, Hyderabad-  
500005



## CERTIFICATE

This is to certify that the Industry Oriented Main Project work report entitled  
"Securing Cloud Data Under key Exposure" which is being submitted  
by **Ayesha Begum [14E31A0565], B. Rajesh [14E31A0566], B. Srikanth [14E31A0569]** in partial fulfilment for the award of the Degree of **BACHELOR OF TECHNOLOGY in COMPUTER SCIENCE AND ENGINEERING** of **JAWAHARLAL NEHRU TECHNOLOGICAL UNIVERSITY HYDERABAD**, is a record of the bonafide work carried out by them under our guidance and supervision.

**Mr. B. Kishore**

Asst. Professor

**Dr. M. Suresh**

Head Of the Department

**Dr. K. S. S. S. Reddy**

**External Examiner**

**PRINCIPAL  
MAHAVEER  
INSTITUTE OF SCIENCE & TECHNOLOGY  
Bandlaguda, Hyd-500 005.**



# MAHAVEER INSTITUTE OF SCIENCE AND TECHNOLOGY

(Affiliated to JNTU Hyderabad, Approved by AICTE)

Vyasapuri, Bandlaguda, Post: Keshavgiri, Hyderabad-500005



## CERTIFICATE

This is to certify that the industry oriented mini project work report entitled "Net Spam: A Network-Based Spam Detection Framework for Reviews in Online Social Media" which is being submitted by **B.Srujan [14E31A0567]**, **Fawaz Ahmed [14E31A0577]**, **L.Sai Teja [14E31A0583]**, **Ch.Sai Teja [14E31A05B5]** in partial fulfilment for the award of the Degree of **BACHELOR OF TECHNOLOGY** in **COMPUTER SCIENCE AND ENGINEERING** of **JAWAHARLAL NEHRU TECHNOLOGICAL UNIVERSITY**, is a record of the bonafide work carried out by them under our guidance and supervision.

Mrs.M.Vijayalaxmi

PROJECT GUIDE

Prof. DR.M.SURESH

HEAD OF THE DEPARTMENT

External Examiner

Dr. K. S. S. S.N. REDDY

PRINCIPAL

PRINCIPAL  
MAHAVEER  
INSTITUTE OF SCIENCE & TECHNOLOGY  
Bandlaguda, Hyd-500 005.







## DEPARTMENT OF AERONAUTICAL ENGINEERING

### PROJECT BATCH LIST (2016-17)

| S.NO |   | H.T.NUMBER |                       | MAJOR PROJECT TITLE                                       |                  |
|------|---|------------|-----------------------|---|------------------|
| 1    | 1 | 13E31A2103 | M shirisha shree      | CFD Investigations On Supercritical & Supersonic Airfoils | Ch vijay chander |
| 2    |   | 13E31A2108 | N ananth kumar        |   |                  |
| 3    | 2 | 13E31A2111 | Syed mohd shuja uddin | Design and Analysis of Scramjet Engine Inlet              | M sravani        |
|      |   | 13E31A2107 | Mohd ussama ahmer     |   |                  |
| 4    |   | 13E31A2112 | K sai sunil kumar     |   |                  |
| 5    | 3 | 13E31A2105 | Mohd abdul raouf      | Design and analysis of fuselage structure                 | M THIRUPATHI     |
| 6    |   | 13E31A2106 | Mohd Abrar            |   |                  |
| 7    | 4 | 13E31A2109 | O prashanth           | Modal Analysis Of A Multi-Section Variable Wing           | Y raghuveer      |

|    |   |            |               |                                     |                |
|----|---|------------|---------------|-------------------------------------|----------------|
| 8  |   | 13E31A2110 | Romil palli   |                                     |                |
| 9  | 5 | 13E31A2102 | G manoj kumar | CFD ANALYSIS ON SPIROID<br>WINGLETS | G rajesh kumar |
| 10 |   | 12WJ1A2119 | Junaid pasha  |                                     |                |

  
 PRINCIPAL  
 M HAVEN  
 INSTITUTE OF SCIENCE & TECHNOLOGY  
 Gandhinagar, Hyd-500 095

  
 HOD



**DEPARTMENT OF AERONAUTICAL ENGINEERING**

Vysapuri, Bandlaguda Post: Koshavgirl,  
Hyderabad-500 005, AP INDIA  
Tel: 040-20020772, 20020773, Fax: 040-24455003  
E-mail: e3hod.aero1@gmail.com  
Website: www.mist.ac.in,

**MAHAVEER**

Approved by AICTE, Affiliated to JNTUH,Hyd.



**CERTIFICATE**

This is to certify that this is the bonafide record of the project titled "CFD INVESTIGATION ON SUPERSONIC AND SUPERCRITICAL AIRFOILS" is submitted by M Shirisha shree, 13E31A2103 and N Anantha Kumar,13E31A2108 of B.Tech in the partial fulfillment of the requirements for the degree of Bachelor of Technology in Aeronautical Engineering, Dept. of Aeronautical Engineering during the year 2016-2017. The results embodied in this project report have not been submitted to any other university or institute for the award of any degree or diploma.

*Ch. Vijay Chander*

Ch Vijay Chander  
M.Tech.(Assistant Professor)  
INTERNAL GUIDE

*M. Arun Kumar*  
Prof. A.RANGA REIDY

M.Tech  
HEAD OF THE DEPARTMENT

*P. Govardhan*  
EXTERNAL EXAMINER

*msl*  
PRINCIPAL  
MAHAVEER  
\*INSTITUTE OF SCIENCE & TECHNOLOGY  
Bandlaguda, Hyderabad



**DEPARTMENT OF AERONAUTICAL ENGINEERING**

aspuri, Bandlaguda Post:Keshavpuram,  
Warangal-500 005, AP INDIA  
Phone: 040-20020772, 20020773, Fax: 040-24455003  
Email: e3hod.aero1@gmail.com  
Website: www.miet.ac.in

**MAHAVEER**

INSTITUTE OF SCIENCE & TECHNOLOGY

Approved by AICTE, Affiliated to JNTUH, Hyd.



**CERTIFICATE**

This is to certify that this is the bonafide record of the main project titled "DESIGN AND ANALYSIS OF SCRAMJET ENGINE INLET RAMP" is submitted by Mohd Ussama Ahmer, Syed Mohd Shuja Uddin And K Sai Sunil Kumar - Roll No 13e31a2107 , 13e31a2111 And 13e31a2112 of B.Tech in the partial fulfillment of the requirements for the degree of Bachelor of Technology in Aeronautical Engineering, Dept. of Aeronautical Engineering during the year 2016-2017. The results embodied in this project report have not been submitted to any other university or institute for the award of any degree or diploma.

  
Mrs. R. SRAWANTHI  
M.Tech.  
INTERNAL GUIDE

  
Mr. Prof. A. RANGA REDDY  
M.Tech.  
HEAD OF THE DEPARTMENT

  
EXTERNAL EXAMINER

  
PRINCIPAL  
MAHAVEER  
INSTITUTE OF SCIENCE & TECHNOLOGY  
Warangal, Hyd-500 005





**DEPARTMENT OF AERONAUTICAL ENGINEERING**

Vysapuri, Bandlaguda Post: Keshavgirl,  
Hyderabad-500 005, AP INDIA  
Tel: 040-20020772, 20020773, Fax: 040-24455003  
E-mail: e3hod.aero1@gmail.com  
Website: www.mist.ac.in,

**MAHAVEER**

INSTITUTE OF SCIENCE & TECHNOLOGY

Approved by AICTE, Affiliated to JNTUH,Hyd.



**CERTIFICATE**

This is to certify that is the bonafide record of the project titled "CFD ANALYSIS ON SPIROID WINGLET" is submitted by MOHAMMED JUNAID PASHA, 12WJIA2119 and G.MANOJ KUMAR, 13E31A2102 of B.Tech in the partial fulfillment of the requirements for the degree of Bachelor of Technology in Aeronautical Engineering, Dept. of Aeronautical Engineering during the year 2016-2017. The results embodied in this technical report have not been submitted to any other university or institute for the award of any degree or diploma.

R. RAJENDHER  
M.Tech.(Assistant Professor)  
INTERNAL GUIDE

Prof. A. RANGA REDDY  
M.Tech  
HEAD OF THE DEPARTMENT

EXTERNAL EXAMINER

*Handwritten signature*  
PRINCIPAL  
MAHAVEER  
INSTITUTE OF SCIENCE & TECHNOLOGY  
BANDLAGUDA POST, VYSAVURI, HYD-500005



**DEPARTMENT OF AERONAUTICAL ENGINEERING**

Vysapuri, Bandlaguda Post: Keshavgi,  
Hyderabad-500 005, AP INDIA  
Tel: 040-20020772, 20020773, Fax: 040-24455003  
E-mail: e3hod.aero1@gmail.com  
Website: www.mist.ac.in,

**MAHAVEER**

INSTITUTE OF SCIENCE & TECHNOLOGY  
Approved by AICTE, Affiliated to JNTUH,Hyd.



**CERTIFICATE**

This is to certify that is the bonafide record of the project titled "DESIGN AND ANALYSIS OF MULTI SECTION VARIABLE WING" is submitted by PRASHANTH.O,13E3A2109 ROMIL PALLI V, 13E31A2110 of B.Tech in the partial fulfillment of the requirements for the degree of Bachelor of Technology in Aeronautical Engineering, Dept. of Aeronautical Engineering during the year 2016-2017. The results embodied in this technical report have not been submitted to any other university or institute for the award of any degree or diploma.



Y.RAGUVEER  
M.Tech.(Assistant Professor)  
INTERNAL GUIDE



Prof. A.RANGA REDDY  
M.Tech  
HEAD OF THE DEPARTMENT



EXTERNAL EXAMINER

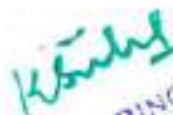

PRINCIPAL  
MAHAVEER  
INSTITUTE OF SCIENCE & TECHNOLOGY  
Bandlaguda, Hyd-500 005





DEPARTMENT OF AERONAUTICAL  
ENGINEERING  
Vyasapuri, Bandlaguda Post: Keshavgi,  
Hyderabad-500 005, AP INDIA  
Tel: 040-20020772, 20020773, Fax: 040-24455003  
E-mail: e3hod.acrol@gmail.com  
Website: www.mist.ac.in,

**MAHAVEER**

INSTITUTE OF SCIENCE & TECHNOLOGY

Approved by AICTE, Affiliated to JNTUH, Hyd.



## CERTIFICATE

This is to certify that this is the bonafide record of the project titled "Design and analysis of fuselage" is submitted by -MOHD ABDUL RAOOF Roll no 13E31A2105 and MOHAMMED ABRAR - Roll no 13E31A2106 of B.Tech in the partial fulfillment of the requirements for the degree of Bachelor of Technology in Aeronautical Engineering, Department of Aeronautical Engineering during the year 2016-2017. The results embodied in this project report have not been submitted to any other university or institute for the award of any degree or diploma.

*f Chivvy chander*  
(CH. VISHY CHANDER)

Mr. M. THIRUPATHI  
M.Tech-(Asst prof)

INTERNAL GUIDE

*A. Ranga Reddy*  
Prof. A.RANGA REDDY  
M.Tech

HEAD OF THE DEPARTMENT

*P. Govindhan*  
EXTERNAL EXAMINER

*Kishu*  
PRINCIPAL  
MAHAVEER  
INSTITUTE OF SCIENCE & TECHNOLOGY  
BANDLAGUDA POST, HYDERABAD





## CERTIFICATION

This is to certify that the project report titled "NON PERFORMING ASSETS" submitted in partial fulfilment for the award of **MASTER OF BUSINESS ADMINISTRATION** by "A.ANUSHA" roll number (15E31E0001) to the **DEPARTMENT OF MANAGEMENT STUDIES, MAHAVEER INSTITUTE OF SCIENCE AND TECHNOLOGY**, affiliated to **JNTU, Hyderabad**, has been carried out under the guidance of "K.RADHIKA" assistant professor, Department of Management studies, MIST.

This project report has not been submitted to any other university or institution for the award of any degree/diploma.

  
(K.RADHIKA)

**INTERNAL GUIDE**

  
(DR. K.KIRAN KUMAR)

**HEAD OF THE DEPARTMENT**



PRINCIPAL

MAHAVEER

INSTITUTE OF SCIENCE & TECHNOLOGY

Bandlaguda, Hyd-500 005.

  
**EXTERNAL GUIDE**







### CERTIFICATION

This is to certify that the project titled "A STUDY ON PERFORMANCE OF MUTUAL FUNDS" at ADITYA BIRLA submitted in partial fulfillment for the award of MASTER OF BUSINESS ADMINISTRATION by AKKAPALLY MADHU BABU Roll No: 15E31E0004 to the Department of Management Studies, Mahaveer Institute of Science and Technology, affiliated to JNTU, Hyderabad, has been carried out under the guidance of DR.K.KIRAN KUMAR, Department of Management Studies, MIST.

This Project report has not been submitted to any other University of Institution for the award of any Degree/Diploma.

(DR. K.KIRAN KUMAR)

INTERNAL GUIDE

(DR. K.KIRAN KUMAR)

HEAD OF DEPARTMENT

*K.K. Kiran Kumar*  
PRINCIPAL  
MAHAVEER  
INSTITUTE OF SCIENCE & TECHNOLOGY  
Bandlaguda, Hyd-500 005.  
*K. Akkapally Madhu Babu*  
EXTERNAL





## CERTIFICATION

This is to certify that the project report titled "CAPITAL STRUCTURE" submitted in partial fulfillment for the award of **MASTER OF BUSINESS ADMINISTRATION** by "A.SHILPA" roll number (15E31E0005) to the **DEPARTMENT OF MANAGEMENT STUDIES, MAHAVEER INSTITUTE OF SCIENCE AND TECHNOLOGY**, affiliated to **JNTU, Hyderabad**, has been carried out under the guidance of "CH.RAGHUNATH REDDY" assistant professor, Department of Management studies, MIST.

This project report has not been submitted to any other university or institution for the award of any degree/diploma.

(CH.RAGHUNATH REDDY)

**INTERNAL GUIDE**

(DR. K.KIRAN KUMAR)

**HEAD OF THE DEPARTMENT**

**MAHAVEER**  
INSTITUTE OF SCIENCE & TECHNOLOGY  
Bandlaguda, Hyd-500 005

**EXTERNAL GUIDE**







## CERTIFICATION

This is to certify that the project titled **“CASH MANAGEMENT”** submitted in partial fulfillment for the award of **MASTER OF BUSINESS ADMINISTRATION** by **AYESHA FATIMA** bearing Roll No: 15E31E0006 to the **Department of Management Studies, Mahaveer Institute of Science and Technology**, affiliated to JNTU, Hyderabad, has been carried out under the guidance of **Ms.K.RADHIKA** Assist. Professor, Department of Management Studies, MIST.

This Project report has not been submitted to any other University of Institution for the award of any Degree/Diploma.

(Ms. K.RADHIKA)

**INTERNAL GUIDE**

(DR. K.KIRAN KUMAR)

PRINCIPAL

MAHAVEER

INSTITUTE OF SCIENCE & TECHNOLOGY

Bandlaguda, Hyderabad - 500 005.

**EXTERNAL**





## CERTIFICATION

This is to certify that the project titled **“RECRUITMENT AND SELECTION”** submitted in partial fulfillment for the award of **MASTER OF BUSINESS ADMINISTRATION** by **BERI MOUNIKA** Roll No: 15E31E0008 to the **Department of Management Studies, Mahaveer Institute of Science and Technology**, affiliated to JNTU, Hyderabad, has been carried out under the guidance of **Mrs.K.VISALI** Assist. Professor, Department of Management Studies, MIST.

This Project report has not been submitted to any other University of Institution for the award of any Degree/Diploma.

  
(Mrs.K. VISALI)

**INTERNAL GUIDE**

  
(DR. K.KIRAN KUMAR)

**HEAD OF DEPARTMENT**

  
PRINCIPAL  
MAHAVEER  
INSTITUTE OF SCIENCE & TECHNOLOGY  
Bandlaguda, Hyd-500 005.

  
**EXTERNAL**







## CERTIFICATION

This is to certify that the project report titled "**FOREIGN EXCHANGE AND ITS RISK MANAGEMENT**" submitted in partial fulfilment for the award of Masters in Business Administration by "**DAMAGALLA SANGEETHA**" roll number (15E31E0010) to the **DEPARTMENT OF MANAGEMENT STUDIES, MAHAVEER INSTITUTE OF SCIENCE AND TECHNOLOGY**, affiliated to **JNTU, Hyderabad**, has been carried out under the guidance of "**CH.RAGHUNATH REDDY**" assistant professor, Department of Management studies, MIST.

This project report has not been submitted to any other university or institution for the award of any degree/diploma.

(C.H.RAGHUNATH REDDY)

INTERNAL GUIDE

(DR. K.KIRAN KUMAR)

HEAD OF THE DEPARTMENT

PRINCIPAL  
MAHAVEER  
INSTITUTE OF SCIENCE & TECHNOLOGY  
Bandlaguda, Hyd-500 005

EXTERNAL GUIDE





## CERTIFICATION

This is to certify that the project report titled "SECURITY ANALYSIS AND PORTFOLIO MANAGEMENT" submitted in partial fulfilment for the award of MASTER OF BUSINESS ADMINISTRATION by "DEVULAPALLY SRAVANTHI" roll number (15E31E0012) to the DEPARTMENT OF MANAGEMENT STUDIES, MAHAVEER INSTITUTE OF SCIENCE AND TECHNOLOGY, affiliated to JNTU, Hyderabad, has been carried out under the guidance of "CH.RAGHUNATH REDDY" assistant professor, Department of Management studies, MIST.

This project report has not been submitted to any other university or institution for the award of any degree/diploma.

(C.H.RAGHUNATH REDDY)

INTERNAL GUIDE

PRINCIPAL  
MAHAVEER  
INSTITUTE OF SCIENCE & TECHNOLOGY  
Bandlaguda, Hyderabad-500 005.

(DR. K.KIRAN KUMAR)

HEAD OF THE DEPARTMENT

EXTERNAL GUIDE







## CERTIFICATION

This is to certify that the project report titled "INVESTMENT OPPORTUNITY IN STOCK MARKET WITH SPECIAL FOCUS ON INFORMATION TECHNOLOGY SECTOR" submitted in partial fulfilment for the award of **MASTER OF BUSINESS ADMINISTRATION** by "DIVYANI SINGH" roll number (15E31E0013) to the **DEPARTMENT OF MANAGEMENT STUDIES, MAHAVEER INSTITUTE OF SCIENCE AND TECHNOLOGY**, affiliated to JNTU, Hyderabad, has been carried out under the guidance of "CH.RAGHUNATH REDDY" assistant professor, Department of Management studies, MIST.

This project report has not been submitted to any other university or institution for the award of any degree/diploma.

(CH.RAGHUNATH REDDY)

INTERNAL GUIDE

(DR. K.KIRAN KUMAR)

HEAD OF THE DEPARTMENT

  
PRINCIPAL  
MAHAVEER  
INSTITUTE OF SCIENCE & TECHNOLOGY  
Bandlaguda, Hyd-500 005.

EXTERNAL GUIDE

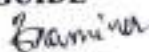





### CERTIFICATION

This is to certify that the project report titled "SYSTEMATIC INVESTMENT PLAN" at Karvy Stock Broking Ltd submitted in partial fulfilment for the award of MASTER OF BUSINESS ADMINISTRATION by "GOLLA SUDHAKAR" roll number (15E31E0015) to the DEPARTMENT OF MANAGEMENT STUDIES, MAHAVEER INSTITUTE OF SCIENCE AND TECHNOLOGY, affiliated to JNTU, Hyderabad, has been carried out under the guidance of "A.V.L.Brinda" assistant professor, Department of Management studies, MIST.

This project report has not been submitted to any other university or institution for the award of any degree/diploma.

(A.V.L.Brinda)

INTERNAL GUIDE

(DR. K.KIRAN KUMAR)

HEAD OF THE DEPARTMENT

*Kavya*  
PRINCIPAL  
MAHAVEER  
INSTITUTE OF SCIENCE & TECHNOLOGY  
Bandlaguda, Hyd-500 005.

*Erani*  
EXTERNAL GUIDE







## CERTIFICATION

This is to certify that the project titled “**JOB SATISFACTION**” submitted in partial fulfillment for the award of **MASTER OF BUSINESS ADMINISTRATION** by G.ANUSHA Roll No: 15E31E0016 to the **Department of Management Studies, Mahaveer Institute of Science and Technology**, affiliated to JNTU, Hyderabad, has been carried out under the guidance of Mrs.K.S. ARCHANA Assist. Professor, Department of Management Studies, MIST.

This Project report has not been submitted to any other University of Institution for the award of any Degree/Diploma.

(Mrs. K.S.ARCHANA)

(DR. K.KIRAN KUMAR)

**INTERNAL GUIDE**

PRINCIPAL  
MAHAVEER  
INSTITUTE OF SCIENCE & TECHNOLOGY  
Bandlaguda, Hyd-500 005.

**HEAD OF DEPARTMENT**

**SIGNATURE OF EXTERNAL EXAMINAR**





## CERTIFICATION

This is to certify that the project report titled "STRESS MANAGEMENT" submitted in partial fulfilment for the award of **MASTER OF BUSINESS ADMINISTRATION** by "K.PRATHYUSHA" roll number (15E31E0018) to the **DEPARTMENT OF MANAGEMENT STUDIES, MAHAVEER INSTITUTE OF SCIENCE AND TECHNOLOGY**, affiliated to JNTU, Hyderabad, has been carried out under the guidance of "Mrs.KS.Archana" assistant professor, Department of management studies, MIST.

This project report has not been submitted to any other university or institution for the award of any degree/diploma.

(Mrs.KS.Archana)

**INTERNAL GUIDE**

PRINCIPAL  
**MAHAVEER**  
INSTITUTE OF SCIENCE & TECHNOLOGY  
Bandlaguda, Hyd-500 005.

(DR. K.KIRAN KUMAR)

**HEAD OF THE DEPARTMENT**

**EXTERNAL GUIDE**





### CERTIFICATION

This is to certify that the project report titled "EQUITY ANALYSIS" GEOJIT TECHNOLOGIES PRIVATE LIMITED submitted in partial fulfilment for the award of MASTER OF BUSINESS ADMINISTRATION by "K.SREENU" roll number (15E31E0020) to the DEPARTMENT OF MANAGEMENT STUDIES, MAHAVEER INSTITUTE OF SCIENCE AND TECHNOLOGY, affiliated to JNTU, Hyderabad, has been carried out under the guidance of "Mrs. K.RADHIKHA" assistant professor, Department of Management studies, MIST.



This project report has not been submitted to any other university or institution for the award of any degree/diploma.

  
(Mrs. K.RADHIKHA)

INTERNAL GUIDE

  
(DR. K.KIRAN KUMAR)

HEAD OF THE DEPARTMENT

  
PRINCIPAL  
MAHAVEER  
INSTITUTE OF SCIENCE & TECHNOLOGY  
Bandlaguda, Hyderabad - 500 005  
  
EXTERNAL GUIDE





## CERTIFICATION

This is to certify that the project titled "**JOB SATISFACTION**" submitted in partial fulfillment for the award of **MASTER OF BUSINESS ADMINISTRATION** by **NAJMA TANVEER** bearing Roll No: 15E31E0025 to the **Department of Management Studies, Mahaveer Institute of Science and Technology**, affiliated to JNTU, Hyderabad, has been carried out under the guidance of Mrs.K.S. ARCHANA Assist. Professor, Department of Management Studies, MIST.

This Project report has not been submitted to any other University of Institution for the award of any Degree/Diploma.

(Mrs K.S.ARCHANA)

(DR. K.KIRAN KUMAR)

INTERNAL GUIDE

PRINCIPAL  
MAHAVEER

INSTITUTE OF SCIENCE & TECHNOLOGY  
Bandlaguda, Hyd-500 005.

30/1/18

SIGNATURE OF EXTERNAL EXAMINAR







## CERTIFICATION

This is to certify that the project report titled “**INVESTOR PREFERENCE TOWARDS CAPITAL MARKET**” submitted in partial fulfilment for the award of **MASTER OF BUSINESS ADMINISTRATION** by “**NARGIS NISHAT**” roll number (15E31E0026) to the **DEPARTMENT OF MANAGEMENT STUDIES, MAHAVEER INSTITUTE OF SCIENCE AND TECHNOLOGY**, affiliated to **JNTU, Hyderabad**, has been carried out under the guidance of “**CH.RAGHUNATH REDDY**” assistant professor, Department of Management studies, MIST.

This project report has not been submitted to any other university or institution for the award of any degree/diploma.

(CH. RAGHUNATH REDDY)

(DR. K.KIRAN KUMAR)

INTERNAL GUIDE

HEAD OF THE DEPARTMENT

*K. Srinivas*  
PRINCIPAL  
MAHAVEER  
INSTITUTE OF SCIENCE & TECHNOLOGY  
Bandlaguda, Hyd-500 005  
*Srinivas*

*Srinivas*  
EXTERNAL GUIDE



### CERTIFICATION

This is to certify that the project report titled "**CAPITAL BUDGETING TECHNIQUES**" submitted in partial fulfilment for the award of **MASTER OF BUSINESS ADMINISTRATION** by "**N.VANDANA**" roll number (15E31E0027) to the **DEPARTMENT OF MANAGEMENT STUDIES, MAHAVEER INSTITUTE OF SCIENCE AND TECHNOLOGY**, affiliated to **JNTU, Hyderabad**, has been carried out under the guidance of "**Mrs.K.Radhika**" assistant professor, Department of Management studies, MIST.

This project report has not been submitted to any other university or institution for the award of any degree/diploma.

  
(Mrs. K. Radhika)

**INTERNAL GUIDE**

  
(DR. K.KIRAN KUMAR)

**HEAD OF THE DEPARTMENT**

  
**PRINCIPAL**  
**MAHAVEER**  
**INSTITUTE OF SCIENCE & TECHNOLOGY**  
Handwritten signature of External Guide  
**EXTERNAL GUIDE**

Financial







### CERTIFICATION

This is to certify that the project report titled "VALUATION OF EQUITY SHARES WITH RESPECT TO NETWORTH COMPANY" submitted in partial fulfilment for the award of **MASTER OF BUSINESS ADMINISTRATION** by "P.PRAKASH REDDY" roll number (15E31E0028) to the **DEPARTMENT OF MANAGEMENT STUDIES, MAHAVEER INSTITUTE OF SCIENCE AND TECHNOLOGY**, affiliated to **JNTU, Hyderabad**, has been carried out under the guidance of "MISS.FOUZIA SHAREEF" assistant professor, Department of Management studies, MIST.

This project report has not been submitted to any other university or institution for the award of any degree/diploma.

(MISS.FOUZIA SHAREEF)

**INTERNAL GUIDE**

(DR. K.KIRAN KUMAR)

**HEAD OF THE DEPARTMENT**

**PRINCIPAL  
MAHAVEER  
INSTITUTE OF SCIENCE & TECHNOLOGY  
Bandlaguda, Hyderabad.**

**EXTERNAL GUIDE**





### CERTIFICATION

This is to certify that the project report titled "PORTFOLIO MANAGEMENT" submitted in partial fulfilment for the award of **MASTER OF BUSINESS ADMINISTRATION** by "P.SOWMIKA REDDY" roll number (15E31E0030) to the **DEPARTMENT OF MANAGEMENT STUDIES, MAHAVEER INSTITUTE OF SCIENCE AND TECHNOLOGY**, affiliated to **JNTU, Hyderabad**, has been carried out under the guidance of "MD.FOUZIA SHAREEF" assistant professor, Department of Management studies, MIST.

This project report has not been submitted to any other university or institution for the award of any degree/diploma.

(MD.FOUZIA SHAREEF)

**INTERNAL GUIDE**

**PRINCIPAL**  
**MAHAVEER**  
**INSTITUTE OF SCIENCE & TECHNOLOGY**  
Bandlaguda, Hyderabad-500 005.

**EXTERNAL GUIDE**

(DR. K.KIRAN KUMAR)

**HEAD OF THE DEPARTMENT**







## CERTIFICATION

This is to certify that the project report titled "NON PERFORMING ASSETS" submitted in partial fulfilment for the award of **MASTER OF BUSINESS ADMINISTRATION** by "POOJA BAGAL" roll number (15E31E0031) to the **DEPARTMENT OF MANAGEMENT STUDIES, MAHAVEER INSTITUTE OF SCIENCE AND TECHNOLOGY**, affiliated to JNTU, Hyderabad, has been carried out under the guidance of "G. KISHORE KUMAR" assistant professor, Department of Management studies, MIST.

This project report has not been submitted to any other university or institution for the award of any degree/diploma.

  
(G.KISHORE KUMAR)

INTERNAL GUIDE

  
(DR. K.KIRAN KUMAR)

HEAD OF THE DEPARTMENT

  
PRINCIPAL  
MAHAVEER  
INSTITUTE OF SCIENCE & TECHNOLOGY  
Bandlaguda, Hyderabad - 500 035.  
EXTERNAL GUIDE





## CERTIFICATION

This is to certify that the project report titled "DEBTORS MANAGEMENT" submitted in partial fulfilment for the award of **MASTER OF BUSINESS ADMINISTRATION** by "A.PREETHI" roll number (15E31E0032) to the **DEPARTMENT OF MANAGEMENT STUDIES, MAHAVEER INSTITUTE OF SCIENCE AND TECHNOLOGY**, affiliated to **JNTU, Hyderabad**, has been carried out under the guidance of "CH.RAGHUNATH REDDY" assistant professor, Department of Management studies, MIST.

This project report has not been submitted to any other university or institution for the award of any degree/diploma.

(CH.RAGHUNATH REDDY)

INTERNAL GUIDE

(DR. K.KIRAN KUMAR)

HEAD OF THE DEPARTMENT

PRINCIPAL  
MAHAVEER  
INSTITUTE OF SCIENCE & TECHNOLOGY  
Bandlaguda, Hyd-500 005.

EXTERNAL GUIDE







## CERTIFICATE

This is to certify that this is a bonafide record of the project carried out by ,  
**R.GEETHA DEVI (15E31E0033)** of the final year MBA (FINANCE), Project  
title on “A Comparative Risk Return Analysis Of Balance And Growth  
Fund” during the academic year 2015-2017 in partial fulfilment of the  
requirements for the award of degree of Master of Business Administration.

**Signature of the H.O.D**  
**Dr.K.Kiran kumar**

**Signature of the Guide**  
**O.Lakshmi narayana**

PRINCIPAL  
MAHAVEER  
INSTITUTE OF SCIENCE & TECHNOLOGY  
Bandlaguda, Hyd-500 005.  
20/1/18  
**Signature of the EXAMINER**





## CERTIFICATION

This is to certify that the project titled **"PROFITABILITY ANALYSIS"** submitted in partial fulfillment for the award of **MASTER OF BUSINESS ADMINISTRATION** by S.DIVYA Roll No: 15E31E0035 to the **Department of Management Studies, Mahaveer Institute of Science and Technology**, affiliated to JNTU, Hyderabad, has been carried out under the guidance of CH RAGHUNATH REDDY Assist. Professor, Department of Management Studies, MIST.

This Project report has not been submitted to any other University of Institution for the award of any Degree/Diploma.

(CH RAGHUNATH REDDY)

**INTERNAL GUIDE**

(DR. K.KIRAN KUMAR)

**HEAD OF DEPARTMENT**

PRINCIPAL  
MAHAVEER  
INSTITUTE OF SCIENCE & TECHNOLOGY  
BANDLAGUDA, HYDRABAD - 500 005.

**SIGNATURE OF EXTERNAL EXAMINAR**





# MAHAVIR INSTITUTE OF SCIENCE AND TECHNOLOGY

(Approved by AICTE, Affiliated to JNTUH - Hyderabad)

(Vengal Rao Nagar, Hanamalguda Post, Keshavnagar, Hyderabad, Andhra Pradesh, India-500 005)  
Ph.no: 91 - 98499 44111. Fax 040-24455003. www.mist.ac.in



## CERTIFICATE

This is to certify that the project work entitled "PERFORMANCE OF HVDC TRANSMISSION LINES WITH FACTS CONTROLLERS FOR POWER SYSTEM STABILIZATION" is the bonafide work carried out and submitted by **KALUPUGULLA ARUN KUMAR** bearing Roll No: 15E31D6401 to Jawaharlal Nehru Technological University, Hyderabad in partial fulfillment of the requirements for the award of the degree of **MASTER OF TECHNOLOGY** in **POWER ENGINEERING AND ENERGY SYSTEMS** during the academic year 2020-21.

**PROJECT GUIDE:**

*A. Mahesh Kumar*  
**A.MAHESH KUMAR**

Assistant professor  
Dept. Of EEE

*Dr. Rajendar Reddy*  
**EXTERNAL EXAMINER**

*Dr. Rajendar Reddy*  
**Dr.RAJENDAR REDDY**

HOD  
Dept. Of EEE

*Kalyan*  
**MEMBER**  
MAHAVIR INSTITUTE OF SCIENCE & TECHNOLOGY  
Vengal Rao Nagar, Hyderabad-500 005

Vysapuri, Bandlaguda Post-Keshavnagar,  
Hyderabad-500 005, Telangana INDIA  
Tel: 040-64596979, 20020773. Fax: 040-24455003  
E-mail: [principal.mahaveer@gmail.com](mailto:principal.mahaveer@gmail.com),  
Website: [www.mist.ac.in](http://www.mist.ac.in),

**MAHAVEER**

INSTITUTE OF SCIENCE & TECHNOLOGY  
Approved by AICTE, Affiliated to JNTUHHyd



**DEPARTMENT OF MECHANICAL ENGINEERING**  
**M.TECH-AMS-MAIN PROJECT LIST (2016-2017)**

| S.NO | NAME OF THE STUDENT | HALL TICKET NO | TITLE OF THE PROJECT   |
|------|---------------------|----------------|--|
| 1    | P.V.SRIRAM          | 15E31D3304     | INVESTIGATING OPTIMUM PROCESS PARAMETERS IN WIRE EDM OF ALUMINUM                 |
| 2    | T.PRANAT KANTH      | 15E31D3306     | INVESTIGATION ON FRICTION STIR WELDING OF ALUMINUM ALLOY                         |
| 3    | K.JAI BHARAT        | 15E31D3307     | OPTIMIZATION PROCESS PARAMETERS ON DIESEINKER EDM PROCESS MACHINING OF P20 STEEL |
| 4    | K.RAVI              | 15E31D3309     | OPTIMIZATION OF PARAMETERS IN SPOT WELDING PROCESS FOR DISIMILAR MATERIALS       |

*K. Srinivas*  
PRINCIPAL  
MAHAVEER  
INSTITUTE OF SCIENCE & TECHNOLOGY  
Bandlaguda, Hyd-500 005.

*Dr. S. Murali*

Dr.S.Murali

DEPARTMENT OF MECHANICAL ENGINEERING



ESTD : 2001

### CERTIFICATE

This is to certify that the project report with title 'INVESTIGATING OPTIMUM PROCESS PARAMETERS IN WIRE CUT EDM OF ALUMINIUM' which is being submitted by P V SRIRAM (15E31D3304) in the partial fulfillment for the award of Master of Technology Degree with specialization in ADVANCED MANUFACTURING SYSTEMS in Mechanical Engineering Department of Mahaveer Institute of Science and Technology, affiliated to Jawaharlal Nehru Technological University Hyderabad.

  
Dr. R. BARI

Professor (Guide)

Dept of Mechanical  
Engineering

  
Dr. S. MURALI

Professor & HOD

Dept of Mechanical  
Engineering

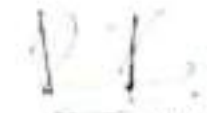

  
PRINCIPAL  
MAHAVEER  
INSTITUTE OF SCIENCE & TECHNOLOGY  
Gandlaguda, Hyderabad-500 005.

  
EXTERNAL EXAMINER





CERTIFICATE

This is to certify that the project report entitled "INVESTIGATION ON FRICTION STIR WELDING OF ALLUMINIUM ALLOY" submitted by T.PRANAY KANTH bearing H.T NO: 15E31D3306 in Partial fulfillment for the award of degree of MASTER OF TECHNOLOGY in ADVANCED MANUFACTURING SYSTEMS to JAWAHARLAL NEHRU TECHNOLOGICAL UNIVERSITY, HYDERABAD as a bonafide work carried out by him under my guidance and supervision.

  
D. SANTOSH KUMAR

Assistant Professor (Project Guide)

DEPARTMENT OF  
MECHANICAL ENGINEERING



Dr. S. MURALI

Professor & Head

DEPARTMENT OF  
MECHANICAL ENGINEERING

  
MAHAVEER  
In-charge, Research  
Cell  
JNTU, Hyderabad-500027

  
EXTERNAL EXAMINER



ESTD 2001

### CERTIFICATE

This is to certify that the project report entitled "OPTIMIZATION PROCESS PARAMETERS IN DIESINKER EDM PROCESS MACHINING OF P20 STEEL" submitted by K.JAI BHARATH, bearing H.T NO 15E31D330" in Partial fulfillment for the award of degree of MASTER OF TECHNOLOGY in ADVANCED MANUFACTURING SYSTEMS to JAWAHARLAL NEHRU TECHNOLOGICAL UNIVERSITY, HYDERABAD as a bonafide work carried out by him under my guidance and supervision.

**D. SANTHOSH KUMAR**

Assistant Professor (Project Guide)

DEPARTMENT OF  
MECHANICAL ENGINEERING

**Dr. S. MURALI**

Professor & Head

DEPARTMENT OF  
MECHANICAL ENGINEERING

**EXTERNAL EXAMINER**

**Principal**  
**MAHAVEER**  
INSTITUTE OF SCIENCE & TECHNOLOGY  
Bandisguda, Hyd-500 005.





ESTD. 2001

## CERTIFICATE

This is to certify that the project report entitled "OPTIMIZATION OF PARAMETERS IN SPOT WELDING PROCESS FOR DISSIMILAR MATERIALS" submitted by K.RAVI bearing H.T NO 15E31D3309 in Partial fulfillment for the award of degree of MASTER OF TECHNOLOGY in ADVANCED MANUFACTURING SYSTEMS to JAWAHARLAL NEHRU TECHNOLOGICAL UNIVERSITY, HYDERABAD as a bonafide work carried out by him under my guidance and supervision.

Dr. B. NAGESHWAR RAO

Professor / Project Guide

DEPARTMENT OF  
MECHANICAL ENGINEERING

Dr. S. MURALI

Professor & Head

DEPARTMENT OF  
MECHANICAL ENGINEERING



PRINCIPAL  
MAHAVEER  
INSTITUTE OF RESEARCH & TECHNOLOGY  
Bangalore, Ind-560 005.

EXTERNAL EXAMINER





# MAHAVEER INSTITUTE OF SCIENCE & TECHNOLOGY

(An ISO 9001 : 2008 Certified Institution)

Vyasapuri, Bandlaguda, Post:Keshavgi, Hyderabad-500 005, AP INDIA

Tel: 040-24455001,002,004 ,Fax: 040-24455003

E-mail: principal.mahaveer@gmail.com Website: www.mist.ac.in

Hyderabad,  
20/07/2016

To,  
The Director,  
CANTER CAD Technologies Pvt. Ltd,  
Hyderabad.

Sub: Recommending the Students for doing IV year B.Tech Internship in You Esteemed Organization  
Respected Sir,

Mahaveer Institute of Science and Technology, a self financed institution located at Bandlaguda near DRDL, was established in the year 2001 and is offering different courses B.Tech & M.Tech with the specialization in CSE, ECE, EEE, IT, CIVIL, AERO& MECHANICAL and other pg courses MBA& MCA

Our IV year B.Tech (CIVIL) student are required to do the internship in your Esteemed Organization

Hence it is requested to give permission to give permission to do her internship in your organization Your cooperation in this regard will be highly appreciated. The details of the student are given below:

| STUDENT NAME: | ROLL NO       |
|---------------|---------------|
| D.DEEKSHA     | (13E31AO114), |
| G.MAHESH      | (13E31AO115), |
| G.SANDEEP     | (13E31AO117), |
| R.VINOD KUMAR | (13E31AO142)  |

Thanking You,

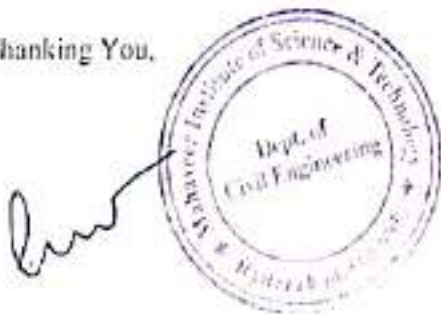

*K. Srinivas*  
PRINCIPAL  
PRINCIPAL  
MAHAVEER  
INSTITUTE OF SCIENCE & TECHNOLOGY  
Bandlaguda, Hyd-500 005.





CAN'FER CIVIL TECHNOLOGIES PVT. LTD.  
 Block 'A' - 4th Floor, Eastwar Tower, above More  
 Supermarket,  
 IS Sodar 'X' Road, Santhoshnagar,  
 Hyderabad - 500 039  
 Ph. + 91 40 6557 3333,  
 Cellr 91 89782 71111  
 Website : www.canfercadd.com



**TO WHOM IT MAY CONCERN**

This is to certify that D.DEEKSHA (13E31AO114), G.MAHESH (13E31AO115), G.SANDEEP (13E31AO117), R.VINOD KUMAR (13E31AO142) Students of B.Tech mini project in CIVIL ENGINEERING at Mahaveer Institute Of Science And Technology has done their project April 2016 to June 2016 for as an in term at CANTER CAD TECHNOLOGIES to accomplish their project "PLANNING OF GATED COMMUNITY" Design and implementation

During the period of the internship with us they were found punctual , hardworking and inquisitive



Corporate Office: JBD, Sri Venkateswara Co-Operative Housing Society, Road No 12, Banjara Hills, Hyderabad - 500 034 India  
 Phone: +91 40 4003 3566 E-mail: info@canfercadd.com Website: www.canfercadd.com

Branch Office: ... .. V.2016.03.23

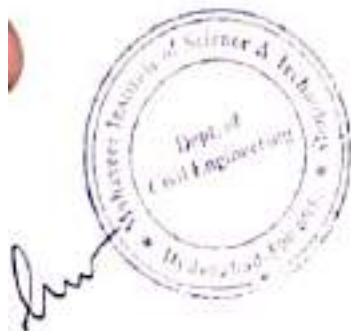

*K. Srinivas*  
 PRINCIPAL  
 MAHAVEER  
 INSTITUTE OF SCIENCE & TECHNOLOGY  
 Bandlaguda, Hyd-500 005



# MAHAVEER INSTITUTE OF SCIENCE & TECHNOLOGY

(An ISO 9001 : 2008 Certified Institution)  
Vyasapuri, Bandlaguda, Post:Keshavpuri, Hyderabad-500 005, AP INDIA  
Tel: 040-24455001,002,004, Fax: 040-24455003  
E-mail: principal.mahaveer@gmail.com Website: [www.mistag.in](http://www.mistag.in)

Hyderabad,  
20/07/2016

To,  
The Director,  
CANTER CAD Technologies Pvt. Ltd,  
Hyderabad.

Sub: Recommending the Students for doing IV year B.Tech Internship in You Esteemed Organization  
Respected Sir,

Mahaveer Institute of Science and Technology, a self financed institution located at Bandlaguda near DRDL, was established in the year 2001 and is offering different courses B.Tech & M.Tech with the specialization in CSE, ECE, EEE, IT, CIVIL, AERO& MECHANICAL and other pg courses MBA& MCA

Our IV year B.Tech (CIVIL) student are required to do the internship in your Esteemed Organization

Hence it is requested to give permission to give permission to do her internship in your organization Your cooperation in this regard will be highly appreciated. The details of the student are given below:

| STUDENT NAME:             | ROLL NO       |
|---------------------------|---------------|
| M.VINOD REDDY             | (13E31AO128), |
| MOHD SHARAZ AHMED         | (13E31AO136), |
| SK SHANAWAZ               | (13E31AO143), |
| AHMED MEHBOOB ALI BUKHARI | (13E31AO148)  |

Thanking You,

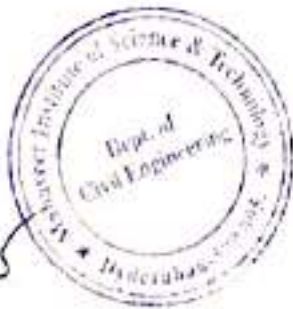

*Kshalya*

PRINCIPAL

FOUNDER  
MAHAVEER  
INSTITUTE OF SCIENCE & TECHNOLOGY  
Bandlaguda, Hyd-500 005.







CAN'FER CADD Technologies Pvt. Ltd  
 Block 'A' - 4th Floor, Eashwar Tower, above More  
 Supermarket,  
 IS Soda 'X' Road, Santhoshnagar,  
 Hyderabad - 500 059  
 Ph. + 91 40 6557 3333,  
 Cell: 91 89782 71111  
 Website: [www.canfercadd.com](http://www.canfercadd.com)



**TO WHOM IT MAY CONCERN**

This is to certify that M.VINOD REDDY (13E31AO128), MOHD SHAROZ AHMED (13E31AO136), SK SHANAWAZ (13E31AO143), AHMED MEHBOOB ALI BUKHARI (13E31AO148) Students of B.Tech mini project in CIVIL ENGINEERING at Mahaveer Institute Of Science And Technology has done their project April 2016 to June 2016 for as an in term at CANTER CAD TECHNOLOGIES to accomplish their project "DESIGN OF PREFABRICATED BUILDING BY USING STAAD PRO VST" Design and implementation

During the period of the internship with us they were found punctual , hardworking and inquisitive



*[Signature]*  
**PRINCIPAL**  
 Corporate Office: 19/31 JBD Sri Venkateswara Co-Operative Housing Society, Road No 12, Banjara Hill, Hyderabad - 500 034 P India  
 Branch: Bandlaguda, Hyderabad  
 Phone: +91 40 4003 3564 E-mail: [info@canfercadd.com](mailto:info@canfercadd.com), [can@canfercadd.com](mailto:can@canfercadd.com), [www@canfercadd.com](mailto:www@canfercadd.com) Website: [www.canfercadd.com](http://www.canfercadd.com)



*[Signature]*  
**PRINCIPAL**  
**MAHAVEER**  
 INSTITUTE OF SCIENCE & TECHNOLOGY  
 Bandlaguda, Hyd-500 005.



# MAHAVEER INSTITUTE OF SCIENCE & TECHNOLOGY

(An ISO 9001 : 2008 Certified Institution)

Vyasapuri, Bandlaguda, Post:Keshavgi, Hyderabad-500 005, AP INDIA

Tel: 040-24455001,002,004 ,Fax: 040-24455003

E-mail: principal.mahaveer@gmail.com Website: www.mist.ac.in

Hyderabad,  
20/07/2016

To,  
The Director,  
CANTER CAD Technologies Pvt. Ltd,  
Hyderabad.

Sub: Recommending the Students for doing IV year B.Tech Internship in Your Esteemed Organization

Respected Sir,

Mahaveer Institute of Science and Technology, a self financed institution located at Bandlaguda near DRDL, was established in the year 2001 and is offering different courses B.Tech & M.Tech with the specialization in CSE, ECE, EEE, IT, CIVIL, AERO& MECHANICAL and other pg courses MBA& MCA

Our IV year B.Tech (CIVIL) student are required to do the internship in your Esteemed Organization

Hence it is requested to give permission to give permission to do her internship in your organization Your cooperation in this regard will be highly appreciated. The details of the student are given below:

STUDENT NAME:

ROLL NO

A.VIJAYA  
CH.KARNAKAR  
G.RAGHAVENDAR  
M.VIJAY

(13E31AO106),  
(13E31AO111),  
(13E31AO118),  
(13E31AO126)

Thanking You,

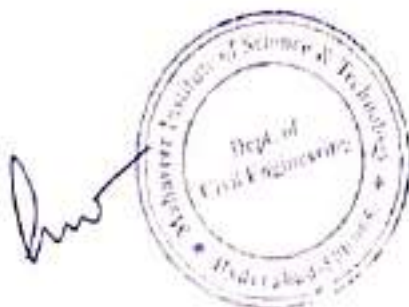

*K. S. S. S.*

PRINCIPAL  
PRINCIPAL  
MAHAVEER  
INSTITUTE OF SCIENCE & TECHNOL. OF  
Bandlaguda, HYD-500 005.





Block 'A'- 4th Floor, Eastwar Tower, above More  
 Supermarket,  
 18 Soda 'X' Road, Santhoshnagar,  
 Hyderabad - 500 059  
 Ph. + 91 40 8551 1133.  
 Cell 91 89782 71111  
 Website - www.cantercadd.com



**TO WHOM IT MAY CONCERN**

This is to certify that A.VIJAYA (13E31AO106), CH.KARNAKAR (13E31AO111), G.RAGHAVENDAR (13E31AO118), M.VIJAY (13E31AO126) Students of B.Tech mini project in CIVIL ENGINEERING at Mahaveer Institute Of Science And Technology has done their project April 2016 to June 2016 for as an in term at CANTER CAD TECHNOLOGIES to accomplish their project "DESIGN AND ANALYSIS OF MULTISTOREY RESIDENTIAL BUILDING (G+5) USING ETABS" Design and implementation

During the period of the internship with us they were found punctual , hardworking and inquisitive



Corporate Office: J80 Sri Venkateswara Co-Operative Housing Society, Road No 12, Banjara Hills, Hyderabad-34 A P India  
 Office: +91 40 4013 3366 E-mail: info@cantercadd.com Website: www.cantercadd.com

Branch: ... ..



*K. Srinivas*  
 PRINCIPAL  
 MAHAVEER  
 INSTITUTE OF SCIENCE & TECHNOLOGY  
 Santhoshnagar, Hyd-500 005.





TRANSMISSION CORPORATION OF TELANGANA LIMITED

## CERTIFICATE

This is to certify that the mini project of B.Tech 4th year EEE student completed at 220/132/33 KV SS CHANDRAYANGUTTA for 15 days from (5-06-2016 to 20-6-2016) and report entitle "STUDY OF SUB-STATION EQUIPMENT" being submitted by MOHD AMANULLAH YASEEN(13E31A0227), in partial fulfillment of the requirements for the award of the degree in Electrical and Electronics Engineering to the MAHAVEER INSTITUTE OF SCIENCE & TECHNOLOGY , vyasapuri, Bandlaguda, post: keshavgirl, hyderabad. Under our guidance and supervision during the above period. The result embodied in this report have not been submitted to any other university of institute for the award of any degree or diploma..

*V. B. Rao*  
Asst. Divisional Engineer  
M/s. 220KV Sub-station,  
TSTRANSCO, Chandrayangutta,  
HYDERABAD-503 097

*Principals*  
PRINCIPAL  
MAHAVEER  
INSTITUTE OF SCIENCE & TECHNOLOGY  
VYASAPURI, BANDLAGUDA, HYDERABAD

*19/6/2016*



भारत भारी इलेक्ट्रिकल्स लिमिटेड  
 भारत हेवी इलेक्ट्रिकल्स लिमिटेड  
 भारी यंत्रण उपकरण निर्माण, रक्षा-उद्योग, डेवरगुड - 500007, आंध्र प्रदेश  
**BHARAT HEAVY ELECTRICALS LIMITED**  
 Heavy Elect. Equipment Plant, Rameswaram, Chennai - 600016, India  
 మానవ వనరుల అభివృద్ధి కేంద్రం / మానవ వనరుల అభివృద్ధి కేంద్రం  
 Human Resources Development Centre



पंजीयन संख्या / Reg. No. 1680

दिनांक / Date 27-06-2016

**परियोजना कार्य प्रशिक्षण प्रमाण पत्र**  
**PROJECT WORK TRAINING CERTIFICATE**

प्रमाणित किया जाता है कि श्री सुधी श्रीमति This is to certify that Mr. / Ms. B. Rama Bathyusha  
 अनुसंधान / Roll No. 13E21A0206 ने Mahaveer Institute of science and technology  
 महाविद्यालय / विश्वविद्यालय / college / university से अध्ययन करते हुए अपना B.Tech  
EEE पाठ्यक्रम में Course परियोजना कार्य / इंटर्नशिप प्रशिक्षण has satisfactorily completed  
 the Project Work / Internship Training from दिनांक Dt. 13-06-2016 से to दिनांक Dt. 27-06-2016 तक  
 सफलतापूर्वक पूर्ण किया है। परियोजना कार्य का शीर्षक / The title of the project is Study of  
Manufacturing Process of Turbo Generator.



*Handwritten signature*  
 INSTITUTE OF SCIENCE & TECHNOLOGY  
 Gundlupeta, Hyd-500 005.

*Handwritten signature*  
 परियोजना प्रशिक्षण प्रभारी  
 Project Training In-Charge  
 के. प्रमिला रानी  
**K. PRAMEELA RANI**  
 वरिष्ठ अभियंता / एच.आर.  
 Sr. Engineer/H



To  
The Head of the Department,  
Electronics & Communication Engineering,  
Mahaveer Institute of Science & Technology,  
Vyasa Puri, Chandrayangutta,  
Hyderabad, Telangana 500005.

## INTERNSHIP CERTIFICATE

### TO WHOMSOEVER IT MAY CONCERN

This is to certify that **Mr.A.Anurag Patel**, Roll Number – **(13E31A0461)**, who is pursuing **Electronics and Communication Engineering**, Department at **Mahaveer Institute of Science & Technology** successfully completed his Internship program at **Conscience Technologies** on **Automatic irrigation for large farms using soil moisture sensor** and has submitted the report.

During the Internship program period, the candidate has shown keen interest and commitment towards learning and his performance was good.

**Duration: 09/05/2016 to 12/07/2016**

Yours truly,

(Project Manager)



*K. Anurag*  
**MAHAVEER**  
INSTITUTE OF SCIENCE & TECHNOLOGY  
Bandlaguda, Hyd-500 005.





To  
The Head of the Department,  
Electronics & Communication Engineering  
Mahaveer Institute of Science & Technology,  
Vyasa Puri, Chandrayangutta,  
Hyderabad, Telangana 500005.

**INTERNSHIP CERTIFICATE**  
**TO WHOMSOEVER IT MAY CONCERN**

This is to certify that **Mr. D.Shashank santhosh**, Roll Number – **(13E31A0474)**, who is pursuing **Electronics and Communication Engineering**, Department at **Mahaveer Institute of Science & Technology** successfully completed his Internship program at; **Conscience Technologies** on **Real Time heartbeat monitoring & Alerting system through GSM** and has submitted the report.

During the Internship program period, the candidate has shown keen interest and commitment towards learning and his performance was good.

**Duration: 09/05/2016 to 12/07/2016**

Yours truly,

(Project Manager)



*Khanji*  
PRINCIPAL  
MAHAVEER  
INSTITUTE OF SCIENCE & TECHNOLOGY  
Bandlaguda, HYD-500 005



DATE: 10-07-2015

Date:10-07-2015

## TO WHOM IT MAY CONCERN

This is to certify that Ms.VASAVI (12E31A576) Mr. Vishanu sai (12E31A582) students of Bachelors of Degree major project in COMPUTER SCIENCE AND ENGINEERING) at " MAHAVEER INSTITUTE OF SCIENCE AND TECHNOLOGY",has done their project JAN-2016 to APRIL-2016 for as an intern at CONSCIENCE TECHNOLOGIES to accomplish their project("LOCKER MANAGEMENT SYSTEM") Design and implementation.

During the Period of the internship with us, they were found punctual, hardworking and inquisitive.

**CONSCIENCE TECHNOLOGIES**

Hyderabad

Authorized Signature

Thanking You



PRINCIPAL  
MAHAVEER  
INSTITUTE OF SCIENCE & TECHNOLOGY  
Boridagada, Hyd-500 605





**CONSCIENCE TECHNOLOGIES**

A RIGHT PLATFORM FOR ALL ENGINEERS.....

DATE: 18-06-2015

Date:15-07-2016

### TO WHOM IT MAY CONCERN

This is to certify that MR.SURYATEJA (13E31A589) Mr. Vishal(13E31A589) SAI PRASAD(13E31A596)students of Bachelors of Degree( major project in COMPUTER SCIENCE AND ENGINEERING) at " MAHAVEER INSTITUTE OF SCIENCE AND TECHNOLOGY ",has done their project JAN-2017 to APRIL-2017 for as an intern at CONSCIENCE TECHNOLOGIES to accomplish their project(MALWARE DETECTION IN CLOUD COMPUTING INFRASTRUCTURES) Design and implementation.

During the Period of the internship with us, they were found punctual, hardworking and inquisitive.

**CONSCIENCE TECHNOLOGIES**

Hyderabad

Authorized Signature

Thanking You,



*Kanhu*  
PRINCIPAL  
MAHAVEER  
INSTITUTE OF SCIENCE AND TECHNOLOGY  
Bandlaguda, Hyderabad-500 605.

www.consciencetechnologies.com  
Info@consciencetechnologies.com

Address  
#17-83/2C, 3rd Floor, Opp. Bank of Maharashtra,  
Annapurna Function Hall Lane,  
Dilsukhnagar, Hyderabad-500060.  
☎ : 040-6012 1199





# MAHAVEER INSTITUTE OF SCIENCE & TECHNOLOGY

(An ISO 9001 : 2008 Certified Institution)

Vyasapuri, Bandlaguda, Post:Keshavgi, Hyderabad-500 005, AP INDIA

Tel: 040-24455001,002,004 ,Fax: 040-24455003

E-mail: principal.mahaveer@gmail.com Website: [www.mist.ac.in](http://www.mist.ac.in)

Hyderabad,  
20/07/2016

To,  
The Director,  
CANTER CAD Technologies Pvt. Ltd,  
Hyderabad.

Sub: Recommending the Students for doing IV year B.Tech Internship in You Esteemed Organization  
Respected Sir,

Mahaveer Institute of Science and Technology, a self financed institution located at Bandlaguda near DRDL, was established in the year 2001 and is offering different courses B.Tech & M.Tech with the specialization in CSE, ECE, EEE, IT, CIVIL, AERO& MECHANICAL and other pg courses MBA& MCA

Our IV year B.Tech (CIVIL) student are required to do the internship in your Esteemed Organization

Hence it is requested to give permission to give permission to do her internship in your organization Your cooperation in this regard will be highly appreciated. The details of the student are given below:

| STUDENT NAME: | ROLL NO       |
|---------------|---------------|
| D.DEEKSHA     | (13E31AO114), |
| G.MAHESH      | (13E31AO115), |
| G.SANDEEP     | (13E31AO117), |
| R.VINOD KUMAR | (13E31AO142)  |

Thanking You,

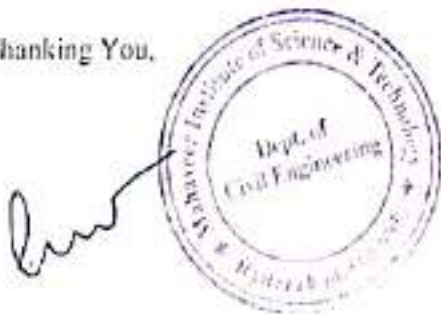

*K. Srinivas*  
PRINCIPAL  
PRINCIPAL  
MAHAVEER  
INSTITUTE OF SCIENCE & TECHNOLOGY  
Bandlaguda, Hyd-500 005.





CAN'FER CIVIL TECHNOLOGIES PVT. LTD.  
 Block 'A' - 4th Floor, Eastwar Tower, above More  
 Supermarket,  
 IS Sodar 'X' Road, Santhoshnagar,  
 Hyderabad - 500 039  
 Ph. + 91 40 6557 3333,  
 Cellr 91 89782 71111  
 Website : www.canfercadd.com



**TO WHOM IT MAY CONCERN**

This is to certify that D.DEEKSHA (13E31AO114), G.MAHESH (13E31AO115), G.SANDEEP (13E31AO117), R.VINOD KUMAR (13E31AO142) Students of B.Tech mini project in CIVIL ENGINEERING at Mahaveer Institute Of Science And Technology has done their project April 2016 to June 2016 for as an in term at CANTER CAD TECHNOLOGIES to accomplish their project "PLANNING OF GATED COMMUNITY" Design and implementation

During the period of the internship with us they were found punctual , hardworking and inquisitive



Corporate [www.cadd.com](http://www.cadd.com) JBD Sri Venkateswara Co-Operative Housing Society, Road No 12, Banjara Hills Hyderabad - 500 034 India  
 of R No +91 40 4003 3566 E-mail \* \* \*, com Website [www.caddtechnologies.com](http://www.caddtechnologies.com)

Branch & V20200323

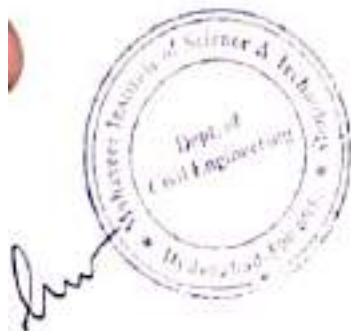

*K. Srinivas*  
 PRINCIPAL  
 MAHAVEER  
 INSTITUTE OF SCIENCE & TECHNOLOGY  
 Bandlaguda, Hyd-500 005



# MAHAVEER INSTITUTE OF SCIENCE & TECHNOLOGY

(An ISO 9001 : 2008 Certified Institution)  
Vyasapuri, Bandlaguda, Post:Keshavgi, Hyderabad-500 005, AP INDIA  
Tel: 040-24455001,002,004, Fax: 040-24455003  
E-mail: principal.mahaveer@gmail.com Website: [www.mistag.in](http://www.mistag.in)

Hyderabad,  
20/07/2016

To,  
The Director,  
CANTER CAD Technologies Pvt. Ltd,  
Hyderabad.

Sub: Recommending the Students for doing IV year B.Tech Internship in You Esteemed Organization  
Respected Sir,

Mahaveer Institute of Science and Technology, a self financed institution located at Bandlaguda near DRDL, was established in the year 2001 and is offering different courses B.Tech & M.Tech with the specialization in CSE, ECE, EEE, IT, CIVIL, AERO& MECHANICAL and other pg courses MBA& MCA

Our IV year B.Tech (CIVIL) student are required to do the internship in your Esteemed Organization

Hence it is requested to give permission to give permission to do her internship in your organization Your cooperation in this regard will be highly appreciated. The details of the student are given below:

| STUDENT NAME:             | ROLL NO       |
|---------------------------|---------------|
| M.VINOD REDDY             | (13E31AO128), |
| MOHD SHARAZ AHMED         | (13E31AO136), |
| SK SHANAWAZ               | (13E31AO143), |
| AHMED MEHBOOB ALI BUKHARI | (13E31AO148)  |

Thanking You,

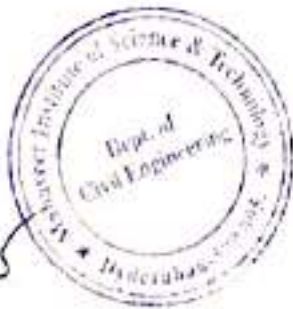

*Kshalya*

PRINCIPAL

FOUNDER  
MAHAVEER  
INSTITUTE OF SCIENCE & TECHNOLOGY  
Bandlaguda, Hyd-500 005.









# MAHAVEER INSTITUTE OF SCIENCE & TECHNOLOGY

(An ISO 9001 : 2008 Certified Institution)

Vyasapuri, Bandlaguda, Post:Keshavgi, Hyderabad-500 005, AP INDIA

Tel: 040-24455001,002,004 ,Fax: 040-24455003

E-mail: principal.mahaveer@gmail.com Website: www.mist.ac.in

Hyderabad,  
20/07/2016

To,  
The Director,  
CANTER CAD Technologies Pvt. Ltd,  
Hyderabad.

Sub: Recommending the Students for doing IV year B.Tech Internship in Your Esteemed Organization

Respected Sir,

Mahaveer Institute of Science and Technology, a self financed institution located at Bandlaguda near DRDL, was established in the year 2001 and is offering different courses B.Tech & M.Tech with the specialization in CSE, ECE, EEE, IT, CIVIL, AERO& MECHANICAL and other pg courses MBA& MCA

Our IV year B.Tech (CIVIL) student are required to do the internship in your Esteemed Organization

Hence it is requested to give permission to give permission to do her internship in your organization Your cooperation in this regard will be highly appreciated. The details of the student are given below:

STUDENT NAME:

ROLL NO

A.VIJAYA  
CH.KARNAKAR  
G.RAGHAVENDAR  
M.VIJAY

(13E31AO106),  
(13E31AO111),  
(13E31AO118),  
(13E31AO126)

Thanking You,

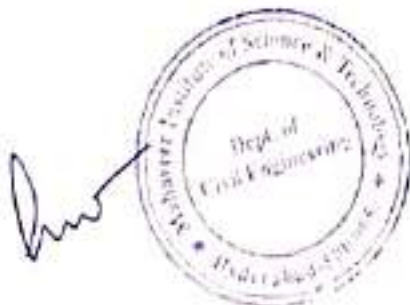

*K. S. S.*

PRINCIPAL  
PRINCIPAL  
MAHAVEER  
INSTITUTE OF SCIENCE & TECHNOL. OF  
BANDLAGUDA, HYD-500 005.





Block 'A'- 4th Floor, Eastwar Tower, above More  
 Supermarket,  
 18 Soda 'X' Road, Sanibeshugur,  
 Hyderabad - 500 059  
 Ph. + 91 40 8551 1133.  
 Cell 91 89782 71111  
 Website - www.cantercadd.com



**TO WHOM IT MAY CONCERN**

This is to certify that A.VIJAYA (13E31AO106), CH.KARNAKAR (13E31AO111), G.RAGHAVENDAR (13E31AO118), M.VIJAY (13E31AO126) Students of B.Tech mini project in CIVIL ENGINEERING at Mahaveer Institute Of Science And Technology has done their project April 2016 to June 2016 for as an in term at CANTER CAD TECHNOLOGIES to accomplish their project "DESIGN AND ANALYSIS OF MULTISTOREY RESIDENTIAL BUILDING (G+5) USING ETABS" Design and implementation

During the period of the internship with us they were found punctual , hardworking and inquisitive



Corporate Office: J80 Sri Venkateswara Co-Operative Housing Society, Road No 12, Banjara Hills, Hyderabad-34 A P India  
 Office: +91 40 4013 3366 E-mail: info@cantercadd.com Website: www.cantercadd.com

Branch: ... ..



*K. Srinivas*  
 PRINCIPAL  
 MAHAVEER  
 INSTITUTE OF SCIENCE & TECHNOLOGY  
 Gandlaguda, Hyd-500 005.





TRANSMISSION CORPORATION OF TELANGANA LIMITED

## CERTIFICATE

This is to certify that the mini project of B.Tech 4th year EEE student completed at 220/132/33 KV SS CHANDRAYANGUTTA for 15 days from (5-06-2016 to 20-6-2016) and report entitle "STUDY OF SUB-STATION EQUIPMENT" being submitted by MOHD AMANULLAH YASEEN(13E31A0227), in partial fulfillment of the requirements for the award of the degree in Electrical and Electronics Engineering to the MAHAVEER INSTITUTE OF SCIENCE & TECHNOLOGY , vyasapuri, Bandlaguda, post: keshavgirl, hyderabad. Under our guidance and supervision during the above period. The result embodied in this report have not been submitted to any other university of institute for the award of any degree or diploma..

*V. B. Rao*  
Asst. Divisional Engineer  
M/s. 220KV Sub-station,  
TSTRANSCO, Chandrayangutta,  
HYDERABAD-503 097

*Principals*  
PRINCIPAL  
MAHAVEER  
INSTITUTE OF SCIENCE & TECHNOLOGY  
VYASAPURI, BANDLAGUDA, HYDERABAD

*19/6/2016*



भारत हेवी इलेक्ट्रिकल्स लिमिटेड  
 भारत हेवी इलेक्ट्रिकल्स लिमिटेड  
 भारी यंत्रण उपकरणों का निर्माण, संधारण, डी.ए.ए.सी. - 200001  
**BHARAT HEAVY ELECTRICALS LIMITED**  
 Heavy Electric Equipment Plant, Ramnagar, Sec 25, Delhi - 110001  
 मानव संसाधन विकास केंद्र / मानव संसाधन विकास केंद्र  
 Human Resources Development Centre



पंजीयन संख्या / Reg. No. 1680

दिनांक / Date 27-06-2016

**परियोजना कार्य प्रशिक्षण प्रमाण पत्र**  
**PROJECT WORK TRAINING CERTIFICATE**

प्रमाणित किया जाता है कि श्री सुधी श्रीमति This is to certify that Mr. / Ms. Mr. B. Rama Bathyusha  
 अनुसंधान / Roll No. 13E21A0206 ने Mahaveer Institute of science and technology  
 महाविद्यालय / विश्वविद्यालय / college / university से अध्ययन करते हुए अपना B.Tech  
EEE पाठ्यक्रम में Course परियोजना कार्य / इंटर्नशिप प्रशिक्षण has satisfactorily completed  
 the Project Work / Internship Training from दिनांक Di 13-06-2016 से to दिनांक Di 27-06-2016 तक  
 सफलतापूर्वक पूर्ण किया है। परियोजना कार्य का शीर्षक / The title of the project is Study of  
Manufacturing Process of Turbo Generator.



*Handwritten signature*  
 INSTITUTE OF SCIENCE & TECHNOLOGY  
 Gundlupeta, Hyd-500 005.

*Handwritten signature*  
 परियोजना प्रशिक्षण प्रभारी  
 Project Training In-Charge  
 के. प्रमिला रानी  
**K. PRAMEELA RANI**  
 वरिष्ठ अभियंता / एच.आर.  
 Sr. Engineer/H



To  
The Head of the Department,  
Electronics & Communication Engineering,  
Mahaveer Institute of Science & Technology,  
Vyasa Puri, Chandrayangutta,  
Hyderabad, Telangana 500005.

## INTERNSHIP CERTIFICATE

### TO WHOMSOEVER IT MAY CONCERN

This is to certify that **Mr.A.Anurag Patel**, Roll Number – **(13E31A0461)**, who is pursuing **Electronics and Communication Engineering**, Department at **Mahaveer Institute of Science & Technology** successfully completed his Internship program at **Conscience Technologies** on **Automatic irrigation for large farms using soil moisture sensor** and has submitted the report.

During the Internship program period, the candidate has shown keen interest and commitment towards learning and his performance was good.

**Duration: 09/05/2016 to 12/07/2016**

Yours truly,

(Project Manager)



*K. Anurag*  
MAHAVEER  
INSTITUTE OF SCIENCE & TECHNOLOGY  
Bandlaguda, Hyd-500 005.





To  
The Head of the Department,  
Electronics & Communication Engineering  
Mahaveer Institute of Science & Technology,  
Vyasa Puri, Chandrayangutta,  
Hyderabad, Telangana 500005.

**INTERNSHIP CERTIFICATE**  
**TO WHOMSOEVER IT MAY CONCERN**

This is to certify that **Mr. D.Shashank santhosh**, Roll Number – **(13E31A0474)**, who is pursuing **Electronics and Communication Engineering**, Department at **Mahaveer Institute of Science & Technology** successfully completed his Internship program at; **Conscience Technologies** on **Real Time heartbeat monitoring & Alerting system through GSM** and has submitted the report.

During the Internship program period, the candidate has shown keen interest and commitment towards learning and his performance was good.

**Duration: 09/05/2016 to 12/07/2016**

Yours truly,

(Project Manager)



*Khanji*  
PRINCIPAL  
MAHAVEER  
INSTITUTE OF SCIENCE & TECHNOLOGY  
Bandlaguda, HYD-500 005



DATE: 10-07-2015

Date:10-07-2015

## TO WHOM IT MAY CONCERN

This is to certify that Ms.VASAVI (12E31A576) Mr. Vishanu sai (12E31A582) students of Bachelors of Degree major project in COMPUTER SCIENCE AND ENGINEERING) at " MAHAVEER INSTITUTE OF SCIENCE AND TECHNOLOGY",has done their project JAN-2016 to APRIL-2016 for as an intern at CONSCIENCE TECHNOLOGIES to accomplish their project("LOCKER MANAGEMENT SYSTEM") Design and implementation.

During the Period of the internship with us, they were found punctual, hardworking and inquisitive.

**CONSCIENCE TECHNOLOGIES**

Hyderabad

Authorized Signature

Thanking You



PRINCIPAL  
MAHAVEER  
INSTITUTE OF SCIENCE & TECHNOLOGY  
Boridagada, Hyd-500 605





**CONSCIENCE TECHNOLOGIES**

A RIGHT PLATFORM FOR ALL ENGINEERS.....

DATE: 18-06-2015

Date:15-07-2016

### TO WHOM IT MAY CONCERN

This is to certify that MR.SURYATEJA (13E31A589) Mr. Vishal(13E31A589) SAI PRASAD(13E31A596)students of Bachelors of Degree( major project in COMPUTER SCIENCE AND ENGINEERING) at " MAHAVEER INSTITUTE OF SCIENCE AND TECHNOLOGY ",has done their project JAN-2017 to APRIL-2017 for as an intern at CONSCIENCE TECHNOLOGIES to accomplish their project(MALWARE DETECTION IN CLOUD COMPUTING INFRASTRUCTURES) Design and implementation.

During the Period of the internship with us, they were found punctual, hardworking and inquisitive.

**CONSCIENCE TECHNOLOGIES**

Hyderabad

Authorized Signature

Thanking You,



*Kanhu*  
PRINCIPAL  
MAHAVEER  
INSTITUTE OF SCIENCE AND TECHNOLOGY  
Bandlaguda, Hyderabad-500 605.

www.consciencetechnologies.com  
Info@consciencetechnologies.com

Address  
#17-83/2C, 3rd Floor, Opp. Bank of Maharashtra,  
Annapurna Function Hall Lane,  
Dilsukhnagar, Hyderabad-500060.  
☎ : 040-6012 1199



Vysapuri, Bandlaguda Post:Keshavnrl,  
Hyderabad-500 005, Telangana INDIA  
Tel: 040-64596979,20020773, Fax: 040-24455003  
E-mail: [principal.mahaveer@gmail.com](mailto:principal.mahaveer@gmail.com),  
Website: [www.mist.ac.in](http://www.mist.ac.in),

**MAHAVEER**  
INSTITUTE OF SCIENCE & TECHNOLOGY  
Approved by AICTE, Affiliated to JNTUH,Hyd.



## PROPOSAL LETTER

Hyderabad,

27/07/2016.

To,

The principal,

MIST,

Hyderabad.

Sub: Proposal for two weeks workshop on AUTO CAD-Reg,

Dear Sir,

We are working as asst professor in the department of CIVIL ENGINEERING. Sir, we are going to conduct two weeks workshop on AUTO CAD. We require your approval to go head for further proceeding and hope to get an opportunity to serve you the best .

With thanks and Regards

From,

Civil Department

Mist,

Bandlaguda,

Hyderabad.



*Kanish*  
PRINCIPAL  
MAHAVEER  
INSTITUTE OF SCIENCE & TECHNOLOGY  
Bandlaguda, Hyd-500 005.



Date: 28.07.2016

## CIRCULAR

Technical Training for II B. Tech students are starting from 1st Aug, 2016 onwards. All HODs and Placements coordinators have to manage the trainings and ensure 95% attendance all through the sessions.

All Mentors need to send the compiled feedback report to CH Swethamber, HOD at [e3hod.civil@gmail.com](mailto:e3hod.civil@gmail.com) daily.

Agenda: 1. Introduction to AUTOCAD.

Designed by: B RAMANA KUMAR



Ch. Swethamber  
HOD

  
PRINCIPAL  
MAHAVEER  
INSTITUTE OF SCIENCE & TECHNOLOGY  
Bandlaguda, Hyd-500



## Auto CAD SYLLABUS

### 1: Getting Started with AutoCAD

- Opening and Creating Drawings
- Exploring the AutoCAD interface
- Zooming and Panning

### 2: Basic Drawing & Editing Commands

- Using the Mouse, Keyboard, and Enter Key to work quickly and efficiently in AutoCAD
- Lines
- Circles
- Rectangles

### 3: Projects - Creating a Simple Drawing

- Creating Simple Drawings
- Using Object Snap Tracking to extrapolate a projected top view
- Using Modify tools to arrange an office layout

### 4: Drawing Precision In AutoCAD

- Polar and Ortho Tracking
- Entering Coordinates and Angles
- Object Snaps and Tracking

### 5: Making Changes in Your Drawing

- Move
- Copy
- Rotate
- Mirror
- Scale
- Using the reference option with the Scale Tool

### 7: Organizing Your Drawing with Layers

- Layer States
- Properties by Layer
- Layer Tools

### B: Advanced Object Types



*Mahaveer*

PRINCIPAL  
MAHAVEER  
INSTITUTE OF SCIENCE & TECHNOLOGY  
Hyderabad, Telangana, India



- Polylines
- Arcs
- Polygons
- Ellipses

#### 9: Advanced Editing Commands

- Trim and Extend
- Fillet and Chamfer
- Polyline Edit and Spline
- Offset and Explode
- Join

#### 10: Inserting Blocks

- The Insert Block Command
- Inserting Blocks with Tool Palettes
- Dynamic Blocs
- Migrating Blocks and other Elements between Drawings with Design Center

#### 11: Text

- The Multiline Text Tool
- The Single Line Text Tool
- Editing Text
- Text in Model Space vs. Paper Space
- The Multileader Tool

#### 12: Hatching

- The Hatch Command
- The Hatch Editor Ribbon Tab
- Saving and Applying Hatches with Tool Palettes

#### 13: Adding Dimensions

- Using Dimensioning Tools
- Dimensioning in a Layout Tab vs. the Model Tab
- Using Dimension Styles
- Editing Dimensions

#### 14. Projects - Annotating Your Drawing

- Dimensioning a Mechanical Drawing



*Kishu*  
 PRINCIPAL  
 MAHAVEER  
 INSTITUTE OF SCIENCE & TECHNOLOGY  
 Bandlaguda, Hyd-500 005.

Vysapuri, Bandlaguda Post:Keshavpuri,  
Hyderabad-500 005, Telangana INDIA  
Tel: 040-64596979,20020773, Fax: 040-24455003  
E-mail: [principal.mahaveer@gmail.com](mailto:principal.mahaveer@gmail.com)  
Website: [www.mst.ac.in](http://www.mst.ac.in)

**MAHAVEER**  
INSTITUTE OF SCIENCE & TECHNOLOGY  
Approved by AICTE. Affiliated to JNTUH.Hyd.



**Department of Civil Engineering**  
**Auto CAD Technical Training student attendance list 2016-17**

| S.No | Hall Ticket No | Name of the Candidate   | Year |
|------|----------------|-------------------------|------|
| 1    | 15E31A010<br>1 | A DIVISHA               | II   |
| 2    | 15E31A010<br>3 | BAGUROTHU SAJUJWALA     | II   |
| 3    | 15E31A010<br>8 | CHANDA VENKATESH        | II   |
| 4    | 15E31A010<br>9 | DIHADI VIJAY            | II   |
| 5    | 15E31A011<br>1 | ELISHETTY TEJASWINI     | II   |
| 6    | 15E31A011<br>2 | ERUKULLA SRIKANTH       | II   |
| 7    | 15E31A011<br>3 | G ABHILASH              | II   |
| 8    | 15E31A011<br>5 | GOPI PRANAY             | II   |
| 9    | 15E31A011<br>7 | LOKASANI SURENDER REDDY | II   |
| 10   | 15E31A011<br>8 | M AVINASH               | II   |
| 11   | 15E31A011<br>9 | MADIRE NARESH           | II   |
| 12   | 15E31A012<br>0 | MD ABDUL MUNAM          | II   |
| 13   | 15E31A012<br>1 | MD SALMAN CHOUDHARY     | II   |
| 14   | 15E31A012<br>2 | MOHAMMED ETHESHAM       | II   |
| 15   | 15E31A012      | MOHD AHMED              | II   |



*Kanish*  
PRINCIPAL  
MAHAVEER  
INSTITUTE OF SCIENCE & TECHNOLOGY  
Bandlaguda, Hyderabad-500 005.

|    |                |                        |    |
|----|----------------|------------------------|----|
|    | 3              |                        | II |
| 16 | 15E31A012<br>4 | MUBARAK AL DAYANI      | II |
| 17 | 15E31A012<br>5 | NENAVATH SANTHOSH      | II |
| 18 | 15E31A013<br>0 | PITTALA RAJESH KUMAR   | II |
| 19 | 15E31A013<br>1 | SABIR ALIE             | II |
| 20 | 15E31A013<br>3 | SHEELAM PRAMOD KUMAR   | II |
| 21 | 15E31A013<br>4 | SIDDINI CHANDU         | II |
| 22 | 15E31A013<br>6 | SRIRANGAM CHARISHMA    | II |
| 23 | 15E31A014<br>0 | VADLA SHRAVAN KUMAR    | II |
| 24 | 15E31A014<br>1 | Y SAIKIRAN             | II |
| 25 | 15E31A014<br>2 | ZEESHAN ASHRAF         | II |
| 26 | 15E31A014<br>3 | M A KHADER ANSARI      | II |
| 27 | 15E31A014<br>4 | PALOJU SRICHAITHANYA   | II |
| 28 | 15E31A014<br>5 | GOLLA VISHNU YADAV     | II |
| 29 | 16E35A010<br>1 | GADDAM CHARAN          | II |
| 30 | 16E35A010<br>2 | GUNDALA MANISH         | II |
| 31 | 16E35A010<br>3 | JANAPATI RAVI          | II |
| 32 | 16E35A010<br>4 | M PRASHANTH            | II |
| 33 | 16E35A010<br>5 | M. RANJITHA            | II |
| 34 | 16E35A010<br>6 | M SIARADA              | II |
| 35 | 16E35A010<br>7 | P.PRAVALIKA            | II |
| 36 | 16E35A010<br>8 | POGAKU KEERTHI MADHURI | II |
| 37 | 16E35A010<br>9 | REDAPAKA MAHESHWARI    | II |



*K. Sankar*  
**PRINCIPAL**  
**MAHAVEER**  
 INSTITUTE OF SCIENCE & TECHNOLOGY  
 Bandlaguda, Hyd-500 005.





| MAHAVEER INSTITUTE OF SCIENCE & TECHNOLOGY, HYDERABAD        |                         |   |   |   |   |   |   |   |   |   |    |
|--|-------------------------|---|---|---|---|---|---|---|---|---|----|
| CIVIL ENGINEERING STUDENTS ATTENDANCE                        |                         |   |   |   |   |   |   |   |   |   |    |
| BATCH YEAR SEM 2016-2017 B.A.TCH Date: 1-8-2016 to 11-8-2016 |                         |   |   |   |   |   |   |   |   |   |    |
| Hall Ticket No   | Name of the Candidate   | 1 | 2 | 3 | 4 | 5 | 6 | 7 | 8 | 9 | 10 |
| 15131A0101   | V DIVINSHA              | P | P | P | A | P | P | P | P | P | P  |
| 15131A0105   | BAGI RODRIGS SAJIDWALIA | P | P | P | P | P | P | P | P | P | P  |
| 15131A0108   | CHANDAVANKA HESHI       | P | P | P | P | P | P | P | P | P | P  |
| 15131A0109   | DHAIDEVYAY              | P | P | P | P | P | P | P | P | P | P  |
| 15131A0111   | ELISHETTY TEJASWINI     | P | P | P | P | P | P | P | P | P | P  |
| 15131A0112   | ERIKUTLA SRIKANTHI      | P | P | P | P | P | P | P | P | P | P  |
| 15131A0113   | G ARBHASI               | P | P | P | P | P | P | P | P | P | P  |
| 15131A0115   | GOOPURANAY              | P | P | P | P | P | P | P | P | P | P  |
| 15131A0117   | HOKASANI SURENDER REDDY | P | P | P | P | P | P | P | P | P | P  |
| 15131A0118   | M AVINASHI              | A | P | P | P | P | P | P | P | P | P  |
| 15131A0119   | MADIRE NARISHI          | P | P | P | P | P | P | P | P | P | P  |
| 15131A0120   | MID ARZUL MUNAM         | P | P | P | P | P | P | P | P | P | P  |
| 15131A0121   | MID SAMAN CHOUDHARY     | P | P | P | P | P | P | P | P | P | P  |
| 15131A0122   | MUHAMMED ETHESHAM       | P | P | P | P | P | P | P | P | P | P  |
| 15131A0123   | MUHAMMED AINAF          | P | P | P | P | P | P | P | P | P | P  |
| 15131A0124   | MU BAREK AL DAYANI      | P | P | P | P | P | P | P | P | P | P  |
| 15131A0125   | NENAVATH SANTHOSH       | P | P | P | P | P | P | P | P | P | P  |
| 15131A0130   | PIJILALA RAMESH KUMAR   | P | P | P | P | P | P | P | P | P | P  |
| 15131A0131   | SABIR ALI               | A | P | P | P | P | P | P | P | P | P  |
| 15131A0133   | SHEETAM PRAMOD KUMAR    | A | P | P | P | P | P | P | P | P | P  |
| 15131A0134   | SIDDHICHANDU            | P | P | P | P | P | P | P | P | P | P  |
| 15131A0136   | SRI PANGANI CHAIRISHIMA | P | P | P | P | P | P | P | P | P | P  |
| 15131A0140   | S ADVA SRIKAVAN KUMAR   | P | P | P | P | P | P | P | P | P | P  |
| 15131A0141   | S SAKRAN                | P | P | P | P | P | P | P | P | P | P  |
| 15131A0142   | ZELSIHAN ASHRAF         | P | P | P | P | P | P | P | P | P | P  |
| 15131A0143   | M A KHADER ANSARI       | P | P | P | P | P | P | P | P | P | P  |
| 15131A0144   | PALOHU SRICHATHAN YA    | P | P | P | P | P | P | P | P | P | P  |
| 15131A0145   | GOLLA VEENU YADAV       | P | P | P | P | P | P | P | P | P | P  |
| 16135A0101   | GADDAM CHARAN           | P | P | P | P | P | P | P | P | P | P  |
| 16135A0102   | GUNDALA MANISHI         | P | P | P | P | P | P | P | P | P | P  |
| 16135A0103   | JANAPALLI RAVI          | P | P | P | P | P | P | P | P | P | P  |
| 16135A0104   | M PRANSHANTHI           | P | P | P | P | P | P | P | P | P | P  |
| 16135A0105   | M RANITHA               | P | P | P | P | P | P | P | P | P | P  |
| 16135A0106   | M SHARADA               | P | P | P | P | P | P | P | P | P | P  |
| 16135A0107   | P PRAVATHA              | P | P | P | P | P | P | P | P | P | P  |
| 16135A0108   | P RAKH KEERTHI MADHURI  | P | P | P | P | P | P | P | P | P | P  |
| 16135A0109   | TEJAPAKA NATH SUWARI    | P | P | P | P | P | P | P | P | P | P  |

PRINCIPAL  
**M. H. VEER**  
 INSTITUTE OF SCIENCE & TECHNOLOGY  
 Hyderabad, India, Ph: 01-500 005.

Vysapuri, Bandlaguda Post, Keshavnagar,  
Hyderabad-500 005, Telangana INDIA  
Tel: 040-64596979, 20020773, Fax: 040-24455003  
E-mail: [principal.mahaveer@gmail.com](mailto:principal.mahaveer@gmail.com),  
Website: [www.mist.ac.in](http://www.mist.ac.in),

**MAHAVEER**  
INSTITUTE OF SCIENCE & TECHNOLOGY  
Approved by AICTE, Affiliated to JNTUH, Hyd.



Technical Training Exam on Auto CAD Software  
(A.Y-2016-17)

2x10=20 Marks

Answer All the Questions

1. Draw the given 2D model by using AutoCad



*K. Srinivas*  
PRINCIPAL  
MAHAVEER  
INSTITUTE OF SCIENCE & TECHNOLOGY  
Bandlaguda, Hyderabad

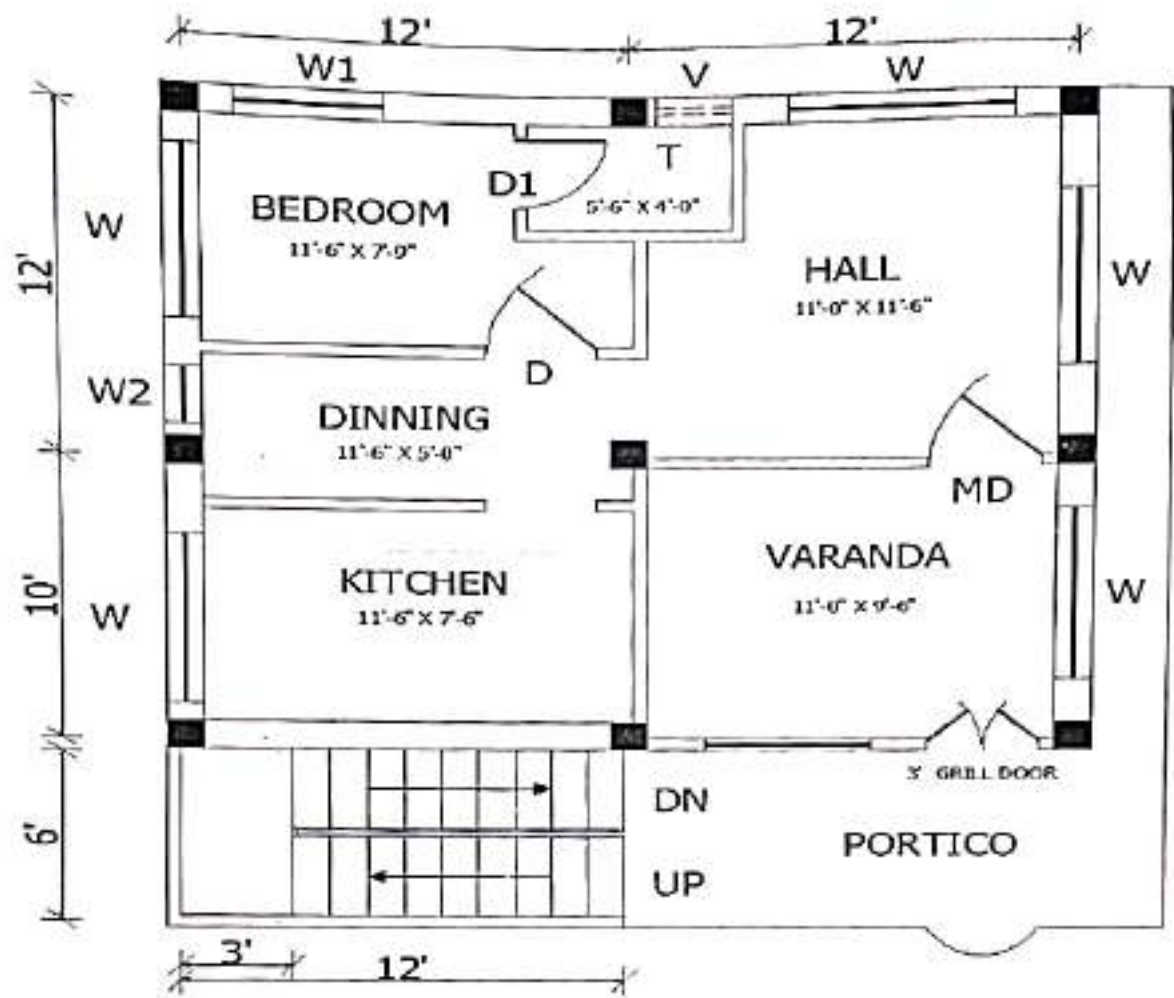

2. (a) Draw the following using any CAD software and add dimensioning.
- (b) List the commands in sequence and also write the procedure
- (c) Add title box containing Student PIN, name and college name



*K. S. Mahaveer*  
**PRINCIPAL**  
**MAHAVEER**  
 INSTITUTE OF SCIENCE & TECH  
 BHARATPUR



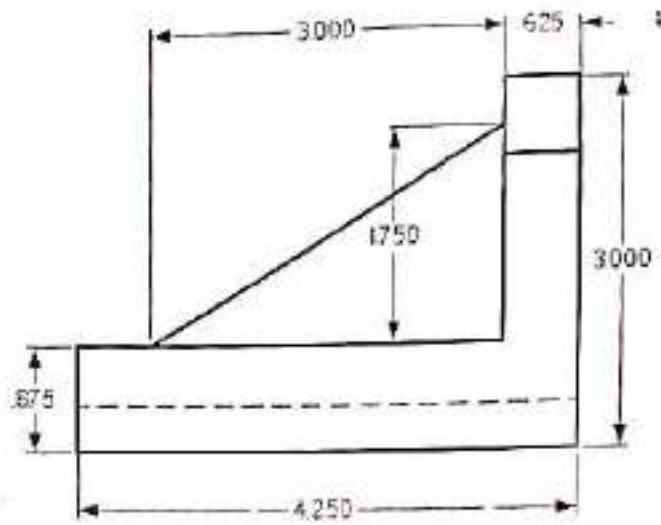
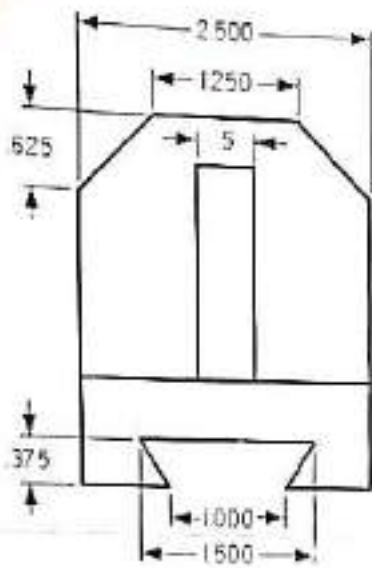

*Handwritten signature*  
**PRINCIPAL**  
**MAHAVEER**  
 INSTITUTE OF SCIENCE & TECHNOLOGY  
 Wardha, Maharashtra

**Department of Civil Engineering**  
**Auto CAD Technical Training student attendance list 2016-17**

| S.No | Hall Ticket No | Name of the Candidate      | Year | Marks | Pass/Fail |
|------|----------------|----------------------------|------|-------|-----------|
| 1    | 15E31A010<br>1 | A DIVISHA                  | II   | 15    | Pass      |
| 2    | 15E31A010<br>3 | BAGUROTHU SAIJWALA         | II   | 16    | Pass      |
| 3    | 15E31A010<br>8 | CHANDA VENKATESH           | II   | 15    | Pass      |
| 4    | 15E31A010<br>9 | DHADI VIJAY                | II   | 15    | Pass      |
| 5    | 15E31A011<br>1 | ELISHETTY TEJASWINI        | II   | 17    | Pass      |
| 6    | 15E31A011<br>2 | ERUKULLA SRIKANTH          | II   | 16    | Pass      |
| 7    | 15E31A011<br>3 | G ABHILASH                 | II   | 16    | Pass      |
| 8    | 15E31A011<br>5 | GOPI PRANAY                | II   | 17    | Pass      |
| 9    | 15E31A011<br>7 | LOKASANI SURENDER<br>REDDY | II   | 15    | Pass      |
| 10   | 15E31A011<br>8 | M AVINASH                  | II   | 15    | Pass      |
| 11   | 15E31A011<br>9 | MADIRE NARESH              | II   | 16    | Pass      |
| 12   | 15E31A012<br>0 | MD ABDUL MUNAM             | II   | 15    | Pass      |
| 13   | 15E31A012<br>1 | MD SALMAN<br>CHOUDHARY     | II   | 18    | Pass      |
| 14   | 15E31A012<br>2 | MOHAMMED ETHESHAM          | II   | 18    | Pass      |
| 15   | 15E31A012<br>3 | MOHD AHMED                 | II   | 13    | Pass      |
| 16   | 15E31A012<br>4 | MUBARAK AL DAYANI          | II   | 14    | Pass      |
| 17   | 15E31A012<br>5 | NENAVATH SANTHOSH          | II   | 15    | Pass      |
| 18   | 15E31A013      | PITTALA RAJESH KUMAR       | II   | 15    | Pass      |



*K. Mahaveer*  
**PRINCIPAL**  
**MAHAVEER**  
 INSTITUTE OF SCIENCE & TECHNOLOGY  
 Bandlaguda, Hyderabad

|    |                |                            |    |    |      |
|----|----------------|----------------------------|----|----|------|
|    | 0              |                            |    |    |      |
| 19 | 15E31A013<br>1 | SABIR ALIE                 | II | 16 | Pass |
| 20 | 15E31A013<br>3 | SHEELAM PRAMOD<br>KUMAR    | II | 16 | Pass |
| 21 | 15E31A013<br>4 | SIDDINI CHANDU             | II | 15 | Pass |
| 22 | 15E31A013<br>6 | SRIRANGAM CHARISHMA        | II | 16 | Pass |
| 23 | 15E31A014<br>0 | VADLA SHRAVAN KUMAR        | II | 17 | Pass |
| 24 | 15E31A014<br>1 | Y SAIKIRAN                 | II | 15 | Pass |
| 25 | 15E31A014<br>2 | ZEESHAN ASHRAF             | II | 15 | Pass |
| 26 | 15E31A014<br>3 | M A KHADER ANSARI          | II | 15 | Pass |
| 27 | 15E31A014<br>4 | PALOJU SRICHAITHANYA       | II | 16 | Pass |
| 28 | 15E31A014<br>5 | GOLLA VISHNU YADAV         | II | 15 | Pass |
| 29 | 16E35A010<br>1 | GADDAM CHARAN              | II | 16 | Pass |
| 30 | 16E35A010<br>2 | GUNDALA MANISH             | II | 16 | Pass |
| 31 | 16E35A010<br>3 | JANAPATI RAVI              | II | 17 | Pass |
| 32 | 16E35A010<br>4 | M PRASHANTH                | II | 18 | Pass |
| 33 | 16E35A010<br>5 | M. RANJITHA                | II | 18 | Pass |
| 34 | 16E35A010<br>6 | M SHARADA                  | II | 16 | Pass |
| 35 | 16E35A010<br>7 | P.PRAVALIKA                | II | 17 | Pass |
| 36 | 16E35A010<br>8 | POGAKU KEERTHI<br>MADIHURI | II | 18 | Pass |
| 37 | 16E35A010<br>9 | REDAPAKA MAHESHWARI        | II | 17 | Pass |



*Mahaveer*  
**PRINCIPAL**  
**MAHAVEER**  
**INSTITUTE OF SCIENCE & TECHNOLOGY**  
 Bandlaguda, Hyd-500 005.



Vysapuri, Bandlaguda Post:Keshavnagar,  
Hyderabad-500 005, Telangana INDIA  
Tel: 040-64596979,20020773, Fax: 040-24455003  
E-mail: [principal.mahaveer@gmail.com](mailto:principal.mahaveer@gmail.com),  
Website: [www.mst.ac.in](http://www.mst.ac.in).

**MAHAVEER**  
INSTITUTE OF SCIENCE & TECHNOLOGY  
Approved by AICTE, Affiliated to JNTUH,Hyd.



**Auto CAD COURSE**  
**Summery**

**Department of Civil Engineering**

- Use AutoCAD for daily working process.
- Navigate throughout AutoCAD using major navigating tools.
- Understand the concept and techniques to draw.
- Create multiple designs using several of tools.
- Create layers to control the objects' visibility.
- Explain drawing using annotations.
- Plot or print the drawing by scale.



*H. Mahaveer*  
PRINCIPAL  
MAHAVEER  
INSTITUTE OF SCIENCE & TECHNOLOGY  
Bandlaguda, Hyd-502 005.

Vysapuri, Bandlaguda Post:Keshavgiri,  
Hyderabad-500 005, Telangana INDIA  
Tel: 040-64596979,20020773, Fax: 040-24455003  
E-mail: [principal.mahaveer@gmail.com](mailto:principal.mahaveer@gmail.com),  
Website: [www.mist.ac.in](http://www.mist.ac.in),

**MAHAVEER**

INSTITUTE OF SCIENCE & TECHNOLOGY

Approved by AICTE, Affiliated to JNTUH,Hyd.



## CERTIFICATE OF COURSE COMPLETION

This certificate is presented to \_\_\_\_\_ of MIST, who has successfully completed technical training course on "Auto CAD" held from \_\_\_\_\_ to \_\_\_\_\_ and found the student performance to be excellent.



ESTD : 2001

*K. Swethamber*  
PRINCIPAL  
MAHAVEER  
INSTITUTE OF SCIENCE & TECHNOLOGY  
Bandlaguda, Hyderabad-500 005.

Ch. Swethamber

HOD

Civil Department



Vysapuri, Bandlaguda Post:Keshargiri,  
Hyderabad-500 025, Telangana INDIA  
Tel: 040-64596979,20020773, Fax: 040-24455003  
E-mail: [principal.mahaveer@gmail.com](mailto:principal.mahaveer@gmail.com),  
Website: [www.mist.ac.in](http://www.mist.ac.in),

**MAHAVEER**

Approved by AICTE, Affiliated to JNTUH,Hyd



**DEPARTMENT OF CIVIL ENGINEERING**

**PROPOSAL LETTER**

Hyderabad,

16/04/2016.

To,  
The principal,  
MIST,  
Hyderabad.

Sub: Proposal for three weeks workshop on REVIT-Reg.

Dear Sir,

We are working as asst professor in the department of CIVIL ENGINEERING. Sir, we are going to conduct three weeks workshop on REVIT. We require your approval to go head for further proceeding and hope to get an opportunity to serve you the best .

With thanks and Regards



*K. S. S. S.*  
**PRINCIPAL**  
**MAHAVEER**  
INSTITUTE OF SCIENCE & TECHNOLOGY  
Bandlaguda, Hyderabad-500025

From,  
Civil Department  
Mist,  
Bandlaguda,



Vysapuri, Bandlaguda Post:Koshavgirl,  
Hyderabad-500 005, Telangana INDIA  
Tel: 040-64596979,20020773, Fax: 040-24455003  
E-mail: [principal.mahaveer@gmail.com](mailto:principal.mahaveer@gmail.com)  
Website: [www.mist.ac.in](http://www.mist.ac.in),

# MAHAVEER

INSTITUTE OF SCIENCE & TECHNOLOGY  
Approved by AICTE, Affiliated to JNTUH,Hyd.



Date: 02.05.2016

## CIRCULAR

Technical Training for B. Tech students are starting from 2nd MAY, 2016 onwards. All HODs and Placements coordinators have to manage the trainings and ensure 95% attendance all through the sessions.

All Mentors need to send the compiled feedback report to CH.Swethamber, HOD at [c3hod.civil@gmail.com](mailto:c3hod.civil@gmail.com) daily.

Agenda: 1. Introduction to Revit.

Designed by :M.SARITHA

K.MAHESH

CH.SWETHAMBER

HOD



*K. Mahesh*

PRINCIPAL  
MAHAVEER  
INSTITUTE OF SCIENCE & TECHNOLOGY  
Bandlaguda, Hyd-500 005.



**REVIT SYLLABUS**

| DAY    | SUBJECT  | KEYWORD  |
|--------|--|--|
| Day-1  | Introduction to BIM & Autodesk Revit               | 1. Introduction to BIM & Revit<br>2. Version of Revit<br>3. Starting Projects<br>4. User Interface   |
| Day-2  | Setting up Levels & wall, adding components        | 1. Making Levels<br>2. wall setup<br>3. 3D Components (Interior & Exterior)                          |
| Day-3  | Working with basic tools                           | 1. Basic modify tools<br>Moving, Copying, Mirror, Trim.<br>2. Working with addition/modify tools     |
| Day-4  | Modelling Floors, Roofs, Stairs, Railings, Ceiling | 1. Making floor & roof<br>2. Creating & Modifying stairs<br>3. Creating Railing<br>4. Adding Ceiling |
| Day-5  | Working with Grid & Column                         | 1. Creating & modify the Grid<br>2. Adding Column  |
| Day-6  | Working with Materials                             | 1. Setting of Materials<br>2. Apply Texture & Colour   |
| Day-7  | Creating Construction Documents                    | 1. Making Sheetfile<br>2. Adding planes, elevations, section, 3D views                               |
| Day-8  | Making Walkthrough                                 | 1. Use of camera<br>2. Making Animation  |
| Day-9  | Introduction to Revit Structure                    | 1. Starting Projects<br>2. Overview of the interface   |
| Day-10 | Starting structural project & basic modify tools   | 1. Setting of Levels & Grids<br>2. working with basic tools (Move, Rotate, Copy, Mirror)             |
| Day-11 | Working with views                                 | 1. Setting the view display<br>2. Creating Elevation & section                                       |
| Day-12 | Structural Grids & Columns                         | 1. Adding Grids<br>2. Placing Columns  |
| Day-13 | Foundation   | 1. Modelling walls<br>2. Adding wall footing<br>3. Adding isolated footing                           |
| Day-14 | Adding Structural Slab                             | 1. Creating & modify Slab  |
| Day-15 | Structural Reinforcement                           | 1. Structural Reinforcement<br>2. Adding Rebar<br>3. Modify Rebar<br>4. Reinforcing Slabs            |

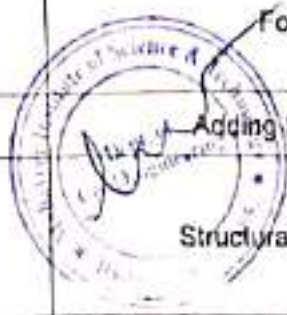

PRINCIPAL  
**MAHAVEER**  
INSTITUTE OF SCIENCE & TECHNOLOGY  
Bandlaguda, Hyd. 500 005



Vysapuri, Bandlaguda Post, Kothavaram,  
Hyderabad-500 005, Telangana INDIA  
Tel: 040-64596979, 20020773, Fax: 040-24455003  
E-mail: [principal.mahaveer@gmail.com](mailto:principal.mahaveer@gmail.com),  
Website: [www.mist.ac.in](http://www.mist.ac.in),

# MAHAVEER

INSTITUTE OF SCIENCE & TECHNOLOGY

Approved by AICTE, Affiliated to JNTUH, Hyd



## Department of Civil Engineering Revit Technical Training student attendance list 2016-2017

| SL.NO. | ROLL NO.   | NAME OF THE STUDENT     | YEAR |
|--------|------------|-------------------------|------|
| 1      | 15E31A0101 | A DIVISHA               | II   |
| 2      | 15E31A0103 | BAGUROTHU SAIUJWALA     | II   |
| 3      | 15E31A0108 | CHANDA VENKATESH        | II   |
| 4      | 15E31A0109 | DHADI VIJAY             | II   |
| 5      | 15E31A0111 | ELISHETTY TEJASWINI     | II   |
| 6      | 15E31A0112 | ERUKULLA SRIKANTH       | II   |
| 7      | 15E31A0113 | G ABHILASH              | II   |
| 8      | 15E31A0115 | GOPI PRANAY             | II   |
| 9      | 15E31A0117 | LOKASANI SURENDER REDDY | II   |
| 10     | 15E31A0118 | M AVINASH               | II   |
| 11     | 15E31A0119 | MADIRE NARESH           | II   |
| 12     | 15E31A0120 | MD ABDUL MUNAM          | II   |
| 13     | 15E31A0121 | MD SALMAN CHOUDHARY     | II   |
| 14     | 15E31A0122 | MOHAMMED ETHESHAM       | II   |
| 15     | 15E31A0123 | MOHD AHMED              | II   |
| 16     | 15E31A0124 | MUBARAK AL DAYANI       | II   |
| 17     | 15E31A0125 | NENAVATH SANTHOSH       | II   |
| 18     | 15E31A0130 | PITTALA RAJESH KUMAR    | II   |
| 19     | 15E31A0131 | SABIR ALI               | II   |
| 20     | 15E31A0133 | SHEELAM PRAMOD KUMAR    | II   |



|    |            |                        |  |
|----|------------|------------------------|--|
| 21 | 15E31A0134 | SIDDINI CHANDU         |  |
| 22 | 15E31A0136 | SRIRANGAM CHARISHMA    |  |
| 23 | 15E31A0140 | VADLA SHRAVAN KUMAR    |  |
| 24 | 15E31A0141 | Y SAIKIRAN             |  |
| 25 | 15E31A0142 | ZEESHAN ASHRAF         |  |
| 26 | 15E31A0143 | M A KHADER ANSARI      |  |
| 27 | 15E31A0144 | PALOJU SRICHAITHANYA   |  |
| 28 | 15E31A0145 | GOLLA VISHNU YADAV     |  |
| 29 | 16E35A0101 | GADDAM CHARAN          |  |
| 30 | 16E35A0102 | GUNDALA MANISH         |  |
| 31 | 16E35A0103 | JANAPATI RAVI          |  |
| 32 | 16E35A0104 | M PRASHANTH            |  |
| 33 | 16E35A0105 | M. RANJITHA            |  |
| 34 | 16E35A0107 | P. PRAVALIKA           |  |
| 35 | 16E35A0108 | POGAKU KEERTHI MADHURI |  |
| 36 | 16E35A0109 | REDAPAKA MAHESHWARI    |  |



*K. S. S. S.*

PRINCIPAL  
**MAHA VEER**  
 INSTITUTE OF SCIENCE & TECHNOLOGY  
 Bandlaguda, Hyd-500 005.











## Technical Training Exam on Revit Software (A.Y-2016-17)

2x10=20 Marks

Answer All the Questions

1. Draw the given 2D model into 3D model by using Revit

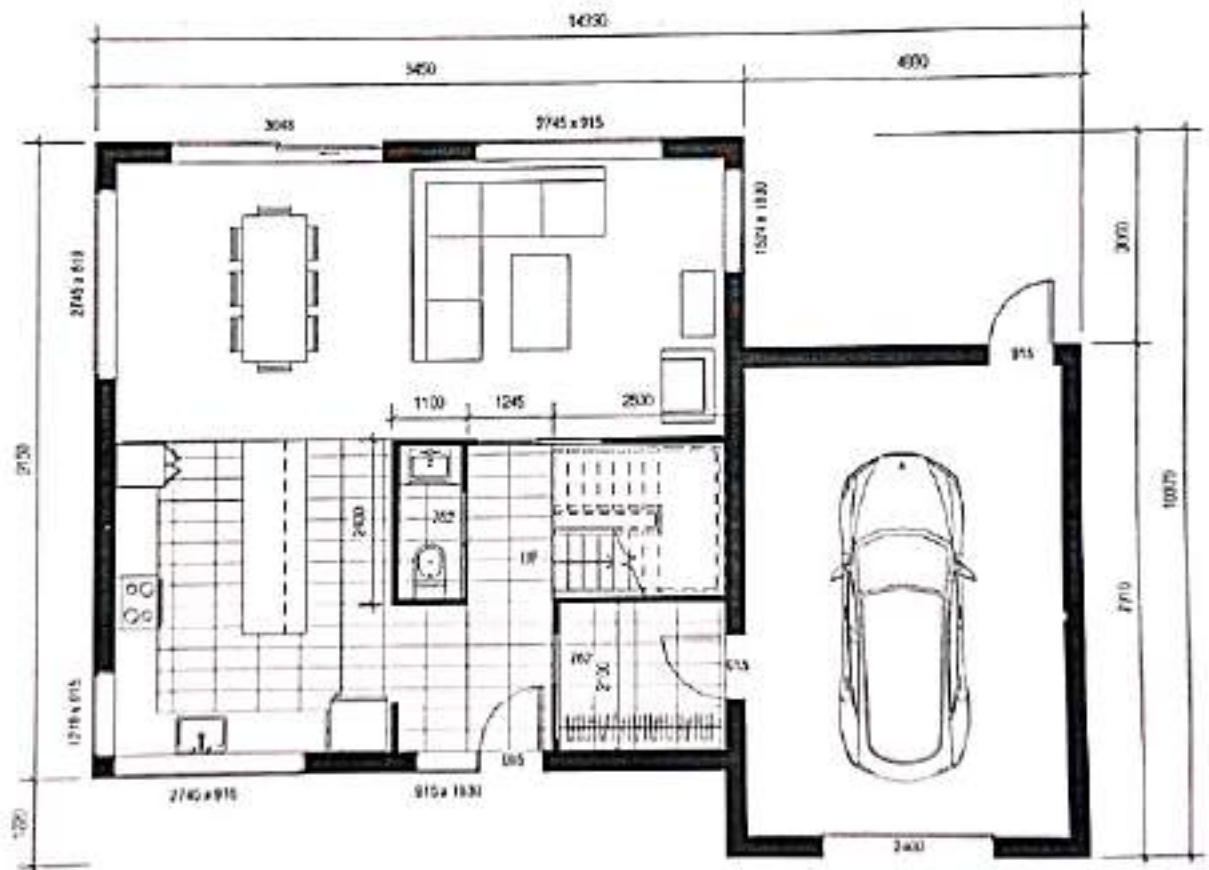

*Principal*

PRINCIPAL  
MAHAVEER  
INSTITUTE OF SCIENCE & TECHNOLOGY  
Bandlaguda, Hyd-500 005.

2. Draw the given centre to centre floor plan into 3D model by using Revit software.

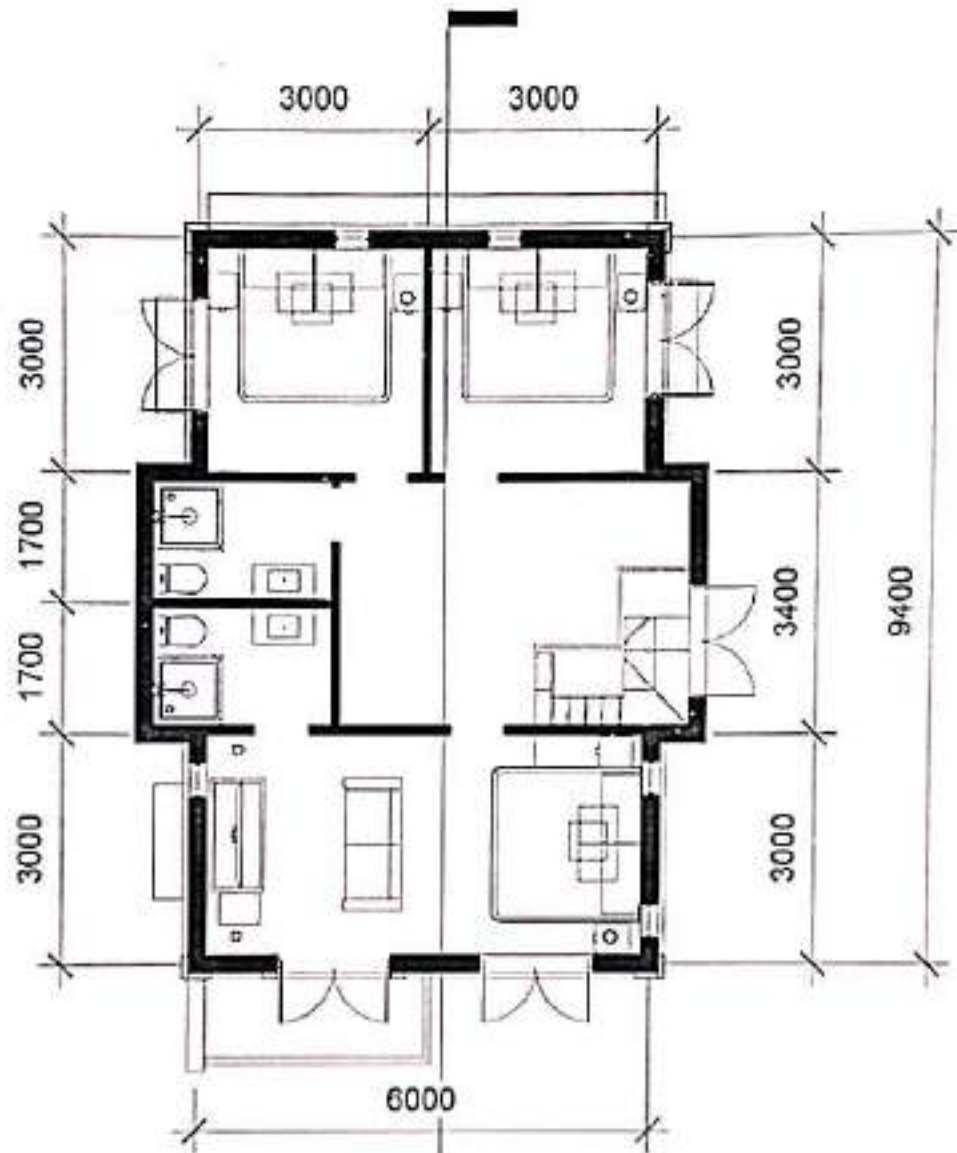

2  
A104



*K. V. S. R.*

PRINCIPAL  
MANAVEER  
INSTITUTE OF SCIENCE & TECHNOLOGY  
Bandlaguda, Hyd-500 005.

Vysapuri, Bandlaguda Post:Keshavnagar,  
Hyderabad-500 005, Telangana INDIA  
Tel: 040-64596979,20020773, Fax: 040-24465003  
E-mail: [principal.mahaveer@gmail.com](mailto:principal.mahaveer@gmail.com),  
Website: [www.mist.ac.in](http://www.mist.ac.in),

**MAHAVEER**

INSTITUTE OF SCIENCE & TECHNOLOGY  
Approved by AICTE, Affiliated to JNTUH,Hyd.



**Department of Civil Engineering  
Revit Technical Training student Marks list 2016-17**

| Sl.NO | Roll No    | Name of the student     | YEAR | MARKS | PASS/FAIL |
|-------|------------|-------------------------|------|-------|-----------|
| 1     | 15E31A0101 | A DIVISHA               | II   | 16    | PASS      |
| 2     | 15E31A0103 | BAGUROTHU SAIUJWALA     | II   | 16    | PASS      |
| 3     | 15E31A0108 | CHANDA VENKATESH        | II   | 12    | PASS      |
| 4     | 15E31A0109 | DHADI VIJAY             | II   | 12    | PASS      |
| 5     | 15E31A0111 | ELISHETTY TEJASWINI     | II   | 16    | PASS      |
| 6     | 15E31A0112 | ERUKULLA SRIKANTH       | II   | 16    | PASS      |
| 7     | 15E31A0113 | G ABHILASH              | II   | 16    | PASS      |
| 8     | 15E31A0115 | GOPI PRANAY             | II   | 16    | PASS      |
| 9     | 15E31A0117 | LOKASANI SURENDER REDDY | II   | 16    | PASS      |
| 10    | 15E31A0118 | M AVINASH               | II   | 16    | PASS      |
| 11    | 15E31A0119 | MADIRE NARESH           | II   | 16    | PASS      |
| 12    | 15E31A0120 | MD ABDUL MUNAM          | II   | 16    | PASS      |
| 13    | 15E31A0121 | MD SALMAN CHOUDHARY     | II   | 16    | PASS      |
| 14    | 15E31A0122 | MOHAMMED ETHESHAM       | II   | 16    | PASS      |
| 15    | 15E31A0123 | MOHD AHMED              | II   | 16    | PASS      |
| 16    | 15E31A0124 | MUBARAK AL DAYANI       | II   | 16    | PASS      |
| 17    | 15E31A0125 | NENAVATH SANTHOSH       | II   | 16    | PASS      |
| 18    | 15E31A0130 | PITTALA RAJESH KUMAR    | II   | 16    | PASS      |
| 19    | 15E31A0131 | SABIR ALI               | II   | 15    | PASS      |
| 20    | 15E31A0133 | SHEELAM PRAMOD KUMAR    | II   | 16    | PASS      |
| 21    | 15E31A0134 | SIDDINI CHANDU          | II   | 16    | PASS      |



*Kanish*

PRINCIPAL  
MAHAVEER

INSTITUTE OF SCIENCE & TECHNOLOGY  
Bandlaguda, Hyd-500 005.



|    |            |                        |    |    |      |
|----|------------|------------------------|----|----|------|
| 22 | 15E31A0136 | SRIRANGAM CHARISHMA    | II | 15 | PASS |
| 23 | 15E31A0140 | VADLA SHRAVAN KUMAR    | II | 16 | PASS |
| 24 | 15E31A0141 | Y SAIKIRAN             | II | 14 | PASS |
| 25 | 15E31A0142 | ZEESHAN ASHRAF         | II | 15 | PASS |
| 26 | 15E31A0143 | M A KHADER ANSARI      | II | 15 | PASS |
| 27 | 15E31A0144 | PALOJU SRICHAITHANYA   | II | 16 | PASS |
| 28 | 15E31A0145 | GOLLA VISHNU YADAV     | II | 14 | PASS |
| 29 | 16E35A0101 | GADDAM CHARAN          | II | 16 | PASS |
| 30 | 16E35A0102 | GUNDALA MANISH         | II | 15 | PASS |
| 31 | 16E35A0103 | JANAPATI RAVI          | II | 14 | PASS |
| 32 | 16E35A0104 | M PRASHANTH            | II | 18 | PASS |
| 33 | 16E35A0105 | M. RANJITHA            | II | 15 | PASS |
| 34 | 16E35A0107 | P.PRAVALIKA            | II | 16 | PASS |
| 35 | 16E35A0108 | POGAKU KEERTHI MADHURI | II | 15 | PASS |
| 36 | 16E35A0109 | REDAPAKA MAHESHWARI    | II | 16 | PASS |



*K. S. S. S.*  
**PRINCIPAL**  
**MAHAVEER**  
 INSTITUTE OF SCIENCE & TECHNOLOGY  
 Bandlaguda, Hyd-500 005.

Vysapuri, Bandlaguda Post: Keshavnagar,  
Hyderabad-500 005, Telangana INDIA  
Tel: 040-84696979, 20020773, Fax: 040-24455003  
E-mail: [principal.mahaveer@gmail.com](mailto:principal.mahaveer@gmail.com),  
Website: [www.mst.ac.in](http://www.mst.ac.in).

**MAHAVEER**

INSTITUTE OF SCIENCE & TECHNOLOGY

Approved by AICTE, Affiliated to JNTUH, Hyd.



**Revit COURSE**  
**Summary**

**Department of Civil Engineering**

- Use Revit for daily working process.
- Navigate throughout Revit using major navigating tools.
- Understand the concept and techniques to draw.
- Create multiple designs using several of tools.
- Create layers to control the objects' visibility.
- Explain drawing using annotations.
- Plot or print the drawing by scale.
- To use constraint for certain design.



*K. S. S. S.*  
PRINCIPAL  
MAHAVEER  
INSTITUTE OF SCIENCE & TECHNOLOGY  
Bandlaguda Post, Keshavnagar, Hyderabad-500 005.

Vysapuri, Bandlaguda Post:Keshavnagar,  
Hyderabad-500 006, Telangana INDIA  
Tel: 040-64596079,20020773, Fax: 040-24455003  
E-mail: [principal.mahaveer@gmail.com](mailto:principal.mahaveer@gmail.com),  
Website: [www.mist.ac.in](http://www.mist.ac.in),

**MAHAVEER**  
INSTITUTE OF SCIENCE & TECHNOLOGY  
Approved by AICTE. Affiliated to JNTUH,Hyd.



## CERTIFICATE OF COURSE COMPLETION

This certificate is presented to \_\_\_\_\_ of MIST, who has successfully completed technical training course on "Revit" held from \_\_\_\_\_ to \_\_\_\_\_ and found the student performance to be excellent.



ESTD : 2001

CH.SWETHAMBER  
HOD

Civil Department



*K. S. S. S.*  
PRINCIPAL  
MAHAVEER  
INSTITUTE OF SCIENCE & TECHNOLOGY  
HYDERABAD



Vysapuri, Bandlaguda Post:Keshavgiri,  
Hyderabad-500 005, Telangana INDIA  
Tel: 040-64596379,20020773, Fax: 040-24455003  
E-mail: [principal.mahaveer@gmail.com](mailto:principal.mahaveer@gmail.com),  
Website: [www.mist.ac.in](http://www.mist.ac.in),

**MAHAVEER**  
INSTITUTE OF SCIENCE & TECHNOLOGY  
Approved by AICTE, Affiliated to JNTUJH,Hyd.



**DEPARTMENT OF CIVIL ENGINEERING**  
**PROPOSAL LETTER**

Hyderabad,

10/08/2016.

To,  
The principal,  
MIST,  
Hyderabad.

Sub: Proposal for three weeks workshop on ETABS-Reg,

Dear Sir,

We are working as asst professor in the department of CIVIL ENGINEERING. Sir, we are going to conduct three weeks workshop on ETABS. We require your approval to go head for further proceeding and hope to get an opportunity to serve you the best .

With thanks and Regards



*Kishor*  
PRINCIPAL  
MAHAVEER  
INSTITUTE OF SCIENCE & TECHNOLOGY  
Bandlaguda, Hyderabad.

From,  
Civil Department  
Mist,  
Bandlaguda,

Vysapuri, Bandlaguda Post:Keshavgiri,  
Hyderabad-500 005, Telangana INDIA  
Tel: 040-64596979,20020773, Fax: 040-24455003  
E-mail: [principal.mahaveer@gmail.com](mailto:principal.mahaveer@gmail.com),  
Website: [www.mist.ac.in](http://www.mist.ac.in),

**MAHAVEER**  
INSTITUTE OF SCIENCE & TECHNOLOGY  
Approved by AICTE, Affiliated to JNTUH,Hyd.



**DEPARTMENT OF CIVIL ENGINEERING**

Hyderabad.

**Date: 12.08.2016**

**CIRCULAR**

Technical Training for III B. Tech students are starting from 12 -08- 2016 onwards. All HODs and Placements coordinators have to manage the trainings and ensure 95% attendance all through the sessions.

All Mentors need to send the compiled feedback report to Ch.Swethamber, HOD at [c3hod.civil@gmail.com](mailto:c3hod.civil@gmail.com) daily.

Agenda: 1. Introduction to ETABS.

CH.SWETHAMBER  
HOD

Design by : B.BRAMANA KUMAR

M.SARITHA

*K. S. Saritha*  
PRINCIPAL  
MAHAVEER  
INSTITUTE OF SCIENCE & TECHNOLOGY  
Bandlaguda, Hyderabad





## DEPARTMENT OF CIVIL ENGINEERING

### ETABS SYLLABUS

- 1: The knowledge about specialized software such as ETABS, SAFE to model and analyze for buildings.
- 2: Be able to model, analyze, and solve structural models on Specialized software and access analysis results such as force, Displacement and another parameter for structural design.
- 3: Be able to communicate and work in the group flexibly and Efficiently.
- 4: Explaining concepts, terminology and rules used in ETABS, SAFE software.
- 5: Modeling and analyzing type of simple and complex structural Systems.
- 6: Analyzing and determining the values of internal forces, Displacements and other parameters for structural design.
- 7: Working in the group to solve the problems relates to using Software ETABS, SAFE.
- 8: Choosing appreciable communication skills such as speech, Text, images, graphics, when expressing personal views.



*K. S. S. S.*  
PRINCIPAL  
MAHAVEER  
INSTITUTE OF SCIENCE & TECHNOLOGY  
HYD.



Vysapuri, Bandlaguda Post:Keshavgi,  
Hyderabad-500 005, Telangana INDIA  
Tel: 040-64596979,20020773, Fax: 040-24455003  
E-mail: [principal.mahaveer@gmail.com](mailto:principal.mahaveer@gmail.com)  
Website: [www.mist.ac.in](http://www.mist.ac.in)

# MAHAVEER

INSTITUTE OF SCIENCE & TECHNOLOGY  
Approved by AICTE, Affiliated to JNTUH, Hvd.



## DEPARTMENT OF CIVIL ENGINEERING ETABS Technical Training student list 2016-17

| SL.NO. | Hall Ticket No | Name of the Candidate       | YEAR |
|--------|----------------|-----------------------------|------|
| 1      | 14E31A0101     | A SRIKANTH                  | III  |
| 2      | 14E31A0102     | ABDUR RAHEEM MUNAWWAR       | III  |
| 3      | 14E31A0103     | AMBATI NEELIMA              | III  |
| 4      | 14E31A0104     | ANKITH KUMAR TIWARI         | III  |
| 5      | 14E31A0105     | AREF ABDUR RAHMAN AL KASERI | III  |
| 6      | 14E31A0106     | AVULA AJAYA LAKSHMI         | III  |
| 7      | 14E31A0107     | BATHARAJU ARUN KUMAR        | III  |
| 8      | 14E31A0108     | BATTHINI VINAY              | III  |
| 9      | 14E31A0109     | BEJJURI PRASHANTH           | III  |
| 10     | 14E31A0111     | BOINPELLI SHRUTHI           | III  |
| 11     | 14E31A0112     | BUDUGULA KIRAN KUMAR        | III  |
| 12     | 14E31A0113     | CHITIKESHI OMPRAKASH        | III  |
| 13     | 14E31A0114     | EPPA OMPRAKASH              | III  |
| 14     | 14E31A0115     | FAIZAN BAIG                 | III  |
| 15     | 14E31A0116     | GADDAVARI SHIVA KRISHNA     | III  |
| 16     | 14E31A0117     | GANDLA SUHRUDH              | III  |
| 17     | 14E31A0118     | GORLA SHRAVANI              | III  |
| 18     | 14E31A0119     | GOTTE TEJASWEI              | III  |
| 19     | 14E31A0120     | ISLAVATH PAVANKUMAR         | III  |
| 20     | 14E31A0121     | JADHAV SAI KRISHNA          | III  |
| 21     | 14E31A0122     | KONUGANTI NIKHIL REDDY      | III  |



*Konuganti Nikhil Reddy*  
PRINCIPAL  
MAHAVEER

INST: 2016/17

Vysapuri, Bandlaguda Post:Keshavnigri,  
Hyderabad-500 005, Telangana INDIA  
Tel: 040-64596979,20020773, Fax: 040-24455003  
E-mail: [principal.mahaveer@gmail.com](mailto:principal.mahaveer@gmail.com),  
Website: [www.mist.ac.in](http://www.mist.ac.in),

# MAHAVEER

INSTITUTE OF SCIENCE & TECHNOLOGY  
Approved by AICTE, Affiliated to JNTU,Hyd.



|    |            |                                |     |
|----|------------|--------------------------------|-----|
| 22 | 14E31A0123 | MAJJARI CHANDRA SHEKHAR        | III |
| 23 | 14E31A0124 | MASARATH JAHAN                 | III |
| 24 | 14E31A0125 | MEKAPOTHULA SANDEEP            | III |
| 25 | 14E31A0126 | MIR SIDDIQ MUQTADIR ALI HASHMI | III |
| 26 | 14E31A0127 | MOGIJI LIKHITHA                | III |
| 27 | 14E31A0128 | MOGULAM ROHITH                 | III |
| 28 | 14E31A0129 | MOHAMMED AIRAJ MOHIUDDIN       | III |
| 29 | 14E31A0130 | MOHAMMED ASIM SULEMAN          | III |
| 30 | 14E31A0131 | MOHAMMED JAWAD UDDIN           | III |
| 31 | 14E31A0133 | MOHD ABDUL ALI FUZAIL          | III |
| 32 | 14E31A0134 | MOHD ABDUL RAOOF               | III |
| 33 | 14E31A0136 | MOHD IBRAHIMA FARUQE           | III |
| 34 | 14E31A0137 | MOHD MOHIUDDIN FAIZ            | III |
| 35 | 14E31A0139 | NAARSING AISHWARYA             | III |
| 36 | 14E31A0140 | NIMMALA THIRUPATHI             | III |
| 37 | 14E31A0141 | PALAM SRIKANTH REDDY           | III |
| 38 | 14E31A0142 | PERAPOGU SHASHI KIRAN          | III |
| 39 | 14E31A0144 | RAVINTHALA NARENDRA BABU       | III |
| 40 | 14E31A0145 | SAYYAD SOHEL                   | III |
| 41 | 14E31A0147 | SHAIK RAHIL FARAZ              | III |
| 42 | 14E31A0148 | SILUVERI MADHUKAR              | III |
| 43 | 14E31A0149 | SOMA SRILATHA                  | III |
| 44 | 14E31A0150 | SYED ISMAIL                    | III |
| 45 | 14E31A0151 | SYED KALEEM ULLAH QUADRI       | III |
| 46 | 14E31A0152 | SYED MOHAMMED FIRDOUSE         | III |
| 47 | 14E31A0153 | SYED MUSTAFA ALI               | III |



*K. S. S. S.*  
PRINCIPAL  
MAHAVEER



Vysapuri, Bandlaguda Post-Keshavpur,  
Hyderabad-500 005, Telangana INDIA  
Tel: 040-64556379, 20020773, Fax: 040-24455003  
E-mail: [principal.mahaveer@gmail.com](mailto:principal.mahaveer@gmail.com)  
Website: [www.mist.ac.in](http://www.mist.ac.in)

# MAHAVEER

INSTITUTE OF SCIENCE & TECHNOLOGY  
Approved by AICTE, Affiliated to JNTUH, Hyd.



|    |            |                                  |     |
|----|------------|----------------------------------|-----|
| 48 | 14E31A0154 | SYED NUMAN                       | III |
| 49 | 14E31A0155 | SYED SAAD SHAREEF                | III |
| 50 | 14E31A0156 | TINGILKAR VISHAL                 | III |
| 51 | 14E31A0157 | VAISHNAVI UPADHYAY               | III |
| 52 | 14E31A0158 | VANAPARTHI SANTHOSH VARMA        | III |
| 53 | 14E31A0159 | VEMULA AVINASH                   | III |
| 54 | 13E31A0102 | ABDUL RAHMAN BIN HASSAN AL YAFAI | III |
| 55 | 15E35A0101 | ALTAF AHMED                      | III |
| 56 | 15E35A0102 | B SAI KRISHNA                    | III |
| 57 | 15E35A0103 | BORRA RAGHU RAM                  | III |
| 58 | 15E35A0104 | GANGULA RATHNA KUMAR             | III |
| 59 | 15E35A0105 | KASTHOORI VENKATAKRISHNA         | III |
| 60 | 15E35A0106 | MD JUNED                         | III |
| 61 | 15E35A0107 | METHUKU SAGAR REDDY              | III |
| 62 | 15E35A0108 | MOHAMMED NADEEMUDDIN             | III |
| 63 | 15E35A0109 | NALLA SHESHU VARDHAN REDDY       | III |
| 64 | 15E35A0110 | NALLAPU VEERA HANUMANATHA RAO    | III |
| 65 | 15E35A0111 | VANKUNAVATH PRAVEEN              | III |
| 66 | 15E35A0112 | V KAVITHA                        | III |
| 67 | 13E31A0105 | AMBALA RAJKUMAR                  | III |



*K. S. S.*  
PRINCIPAL  
MAHAVEER  
INSTITUTE OF SCIENCE & TECHNOLOGY  
Bandlaguda, Hyd. 500 005



MAHAVEER INSTITUTE OF SCIENCE & TECHNOLOGY, HYDERABAD

CIVIL ENGINEERING STUDENTS ATTENDANCE

B.TECH I YEAR I SEM 2016-2017 BATCH (Date: 12-8-2016 to 24-08-2016)

| S.No | Hall Ticket No | Name of the Candidate           | 1 | 2 | 3 | 4 | 5 | 6 | 7 | 8 | 9 | 10 |
|------|----------------|---------------------------------|---|---|---|---|---|---|---|---|---|----|
| 1    | 14E31A0101     | A SRIKANTH                      | P | P | P | P | P | A | P | P | P | P  |
| 2    | 14E31A0102     | ABDUR RAHEEM MUNAWWAR           | P | P | P | A | P | P | P | P | P | P  |
| 3    | 14E31A0103     | AMBATTI NEELIMA                 | A | P | P | P | P | P | P | P | P | P  |
| 4    | 14E31A0104     | ANNITH KUMAR TIWARI             | P | P | P | P | A | P | P | P | P | P  |
| 5    | 14E31A0105     | AREF ABDUR RAHMAN AL KASERI     | A | P | P | P | P | P | P | P | P | P  |
| 6    | 14E31A0106     | AVULA AJAYA LAKSHMI             | P | P | A | P | P | P | P | P | P | P  |
| 7    | 14E31A0107     | BATHARAJU ARUN KUMAR            | P | P | P | P | P | P | A | P | P | P  |
| 8    | 14E31A0108     | BATTHINI VINAY                  | A | P | P | P | P | P | P | P | P | P  |
| 9    | 14E31A0109     | BEJJURI PRASHANTH               | P | A | P | P | P | P | P | P | P | P  |
| 10   | 14E31A0111     | BOINPELLI SHRUTHI               | P | P | A | P | P | P | P | P | P | P  |
| 11   | 14E31A0112     | BUDUGULA KIRAN KUMAR            | P | P | P | P | P | P | P | P | P | P  |
| 12   | 14E31A0113     | CHITIKESHI OMPRAKASH            | A | P | P | A | P | P | P | P | P | P  |
| 13   | 14E31A0114     | EPPA OMPRAKASH                  | P | P | P | P | P | P | P | P | P | P  |
| 14   | 14E31A0115     | FAIZAN BAIG                     | P | A | P | P | P | A | P | P | P | P  |
| 15   | 14E31A0116     | GADDAVARI SHIVA KRISHNA         | P | P | P | P | P | P | P | P | P | P  |
| 16   | 14E31A0117     | GANDLA SUHRUDH                  | P | P | P | P | P | A | P | P | P | P  |
| 17   | 14E31A0118     | GORLA SHRAVANI                  | P | P | P | P | P | P | P | A | P | P  |
| 18   | 14E31A0119     | GOTTE TEJASWEI                  | P | P | P | P | A | P | P | P | P | P  |
| 19   | 14E31A0120     | ISLAVATH PAVANKUMAR             | P | A | P | P | P | P | P | P | P | P  |
| 20   | 14E31A0121     | JADHAV SAI KRISHNA              | P | P | P | P | A | P | P | P | P | P  |
| 21   | 14E31A0122     | KONUGANTI NIKHIL REDDY          | P | P | P | P | P | P | P | P | P | P  |
| 22   | 14E31A0123     | MAJARI CHANDRA SHEKHAR          | P | A | P | P | P | P | P | P | P | P  |
| 23   | 14E31A0124     | MASARATH JAHAN                  | A | P | P | P | P | P | A | P | P | P  |
| 24   | 14E31A0125     | MEKAPOTHULA SANDEEP             | P | P | P | P | P | P | P | P | P | P  |
| 25   | 14E31A0126     | MIR SIDDIQ MUQTADIR ALI HASHIMI | P | P | P | P | P | P | A | P | P | P  |
| 26   | 14E31A0127     | MOGILI UKHITHA                  | P | P | P | P | P | P | P | P | A | P  |



MAHAVEER INSTITUTE OF SCIENCE & TECHNOLOGY  
HYDERABAD  
Date: 12-8-2016











**DEPARTMENT OF CIVIL ENGINEERING**

Technical Training Exam on Etabs Software  
(A.Y-2016-17)

2x10=20 Marks

Answer All the Questions

1) Design of composite steel using etabs

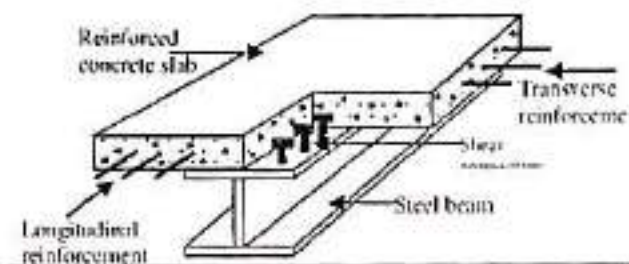

2) composite column using etabs

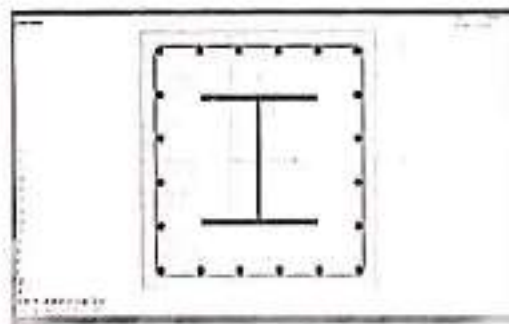

*K. Mahaveer*  
PRINCIPAL  
MAHAVEER  
INSTITUTE OF SCIENCE & TECHNOLOGY  
Bandlaguda, Hyderabad



## DEPARTMENT OF CIVIL ENGINEERING ETABS Technical Training student Marks list 2016-17

| Sl.NO | Hall Ticket No | Name of the Candidate       | YEAR | MARKS | PASS/FAI |
|-------|----------------|-----------------------------|------|-------|----------|
| 1     | 14E31A0101     | A SRIKANTH                  | III  | 16    | PASS     |
| 2     | 14E31A0102     | ABDUR RAHEEM MUNAWWAR       | III  | 16    | PASS     |
| 3     | 14E31A0103     | AMBATI NEELIMA              | III  | 12    | PASS     |
| 4     | 14E31A0104     | ANKITH KUMAR TIWARI         | III  | 12    | PASS     |
| 5     | 14E31A0105     | AREF ABDUR RAHMAN AL KASERI | III  | 16    | PASS     |
| 6     | 14E31A0106     | AVULA AJAYA LAKSHMI         | III  | 16    | PASS     |
| 7     | 14E31A0107     | BATHARAJU ARUN KUMAR        | III  | 16    | PASS     |
| 8     | 14E31A0108     | BATTHINI VINAY              | III  | 16    | PASS     |
| 9     | 14E31A0109     | BEJJURI PRASHANTH           | III  | 16    | PASS     |
| 10    | 14E31A0111     | BOINPELLI SHRUTHI           | III  | 16    | PASS     |
| 11    | 14E31A0112     | BUDUGULA KIRAN KUMAR        | III  | 16    | PASS     |
| 12    | 14E31A0113     | CHITIKESHI OMPRAKASH        | III  | 16    | PASS     |
| 13    | 14E31A0114     | EPPA OMPRAKASH              | III  | 16    | PASS     |
| 14    | 14E31A0115     | FAIZAN BAIG                 | III  | 16    | PASS     |
| 15    | 14E31A0116     | GADDAVARI SHIVA KRISHNA     | III  | 16    | PASS     |
| 16    | 14E31A0117     | GANDLA SUHRUDH              | III  | 16    | PASS     |
| 17    | 14E31A0118     | GORLA SHRAVANI              | III  | 16    | PASS     |
| 18    | 14E31A0119     | GOTTE TEJASWEI              | III  | 16    | PASS     |
| 19    | 14E31A0120     | ISLAVATH PAVANKUMAR         | III  | 15    | PASS     |
| 20    | 14E31A0121     | JADHAV SAI KRISHNA          | III  | 16    | PASS     |
| 21    | 14E31A0122     | KONUGANTI NIKHIL REDDY      | III  | 16    | PASS     |
| 22    | 14E31A0123     | MAJJARI CHANDRA SHEKHAR     | III  | 15    | PASS     |



*K. S. S. S.*  
PRINCIPAL  
MAHAVEER  
INSTITUTE OF SCIENCE & TECHNOLOGY  
Bandlaguda, Hyd-500 005.

Vysapuri, Bandlaguda Post:Keshavgiri,  
Hyderabad-500 005, Telangana INDIA  
Tel: 040-64596979,20020773, Fax: 040-24455003  
E-mail: [principal.mahaveer@gmail.com](mailto:principal.mahaveer@gmail.com),  
Website: [www.mist.ac.in](http://www.mist.ac.in),

# MAHAVEER

INSTITUTE OF SCIENCE & TECHNOLOGY  
Approved by AICTE, Affiliated to JNTUH,Hyd.



|    |            |                                |     |    |      |
|----|------------|--------------------------------|-----|----|------|
| 23 | 14E31A0124 | MASARATH JAHAN                 | III | 16 | PASS |
| 24 | 14E31A0125 | MEKAPOTHULA SANDEEP            | III | 14 | PASS |
| 25 | 14E31A0126 | MIR SIDDIQ MUQTADIR ALI HASHMI | III | 15 | PASS |
| 26 | 14E31A0127 | MOGILI LIKHITHA                | III | 15 | PASS |
| 27 | 14E31A0128 | MOGULAM ROHITH                 | III | 16 | PASS |
| 28 | 14E31A0129 | MOHAMMED AIRAJ MOHIUDDIN       | III | 14 | PASS |
| 29 | 14E31A0130 | MOHAMMED ASIM SULEMAN          | III | 16 | PASS |
| 30 | 14E31A0131 | MOHAMMED JAWAD UDDIN           | III | 15 | PASS |
| 31 | 14E31A0133 | MOHD ABDUL ALI FUZAIL          | III | 14 | PASS |
| 32 | 14E31A0134 | MOHD ABDUL RAOOF               | III | 18 | PASS |
| 33 | 14E31A0136 | MOHD IBRAHIMA FARUQE           | III | 15 | PASS |
| 34 | 14E31A0137 | MOHD MOHIUDDIN FAIZ            | III | 16 | PASS |
| 35 | 14E31A0139 | NAARSING AISHWARYA             | III | 15 | PASS |
| 36 | 14E31A0140 | NIMMALA THIRUPATHI             | III | 16 | PASS |
| 37 | 14E31A0141 | PALAM SRIKANTH REDDY           | III | 16 | PASS |
| 38 | 14E31A0142 | PERAPOGU SHASHI KIRAN          | III | 15 | PASS |
| 39 | 14E31A0144 | RAVINOHALA NARENDRA BABU       | III | 16 | PASS |
| 40 | 14E31A0145 | SAYYAD SOHEL                   | III | 16 | PASS |
| 41 | 14E31A0147 | SHAIK RAHIL FARAZ              | III | 15 | PASS |
| 42 | 14E31A0148 | SILUVERI MADHUKAR              | III | 16 | PASS |
| 43 | 14E31A0149 | SOMA SRILATHA                  | III | 14 | PASS |
| 44 | 14E31A0150 | SYED ISMAIL                    | III | 15 | PASS |
| 45 | 14E31A0151 | SYED KALEEM ULLAH QUADRI       | III | 15 | PASS |
| 46 | 14E31A0152 | SYED MOHAMMED FIRDOUSE         | III | 16 | PASS |
| 47 | 14E31A0153 | SYED MUSTAFA ALI               | III | 14 | PASS |
| 48 | 14E31A0154 | SYED NUMAN                     | III | 16 | PASS |



*K. Subh*  
PRINCIPAL  
MAHAVEER  
INSTITUTE OF SCIENCE & TECHNOLOGY  
Bandlaguda, Hyd-500 005.



Vysapuri, Bandlaguda Post:Keshavgiri,  
Hyderabad-500 005, Telangana INDIA  
Tel: 040-64596979,20020773, Fax: 040-24455003  
E-mail: [principal.mahaveer@gmail.com](mailto:principal.mahaveer@gmail.com),  
Website: [www.mist.ac.in](http://www.mist.ac.in),

# MAHAVEER

INSTITUTE OF SCIENCE & TECHNOLOGY

Approved by AICTE, Affiliated to JNTUH,Hyd.



|    |            |                                  |     |    |      |
|----|------------|----------------------------------|-----|----|------|
| 49 | 14E31A0155 | SYED SAAD SHAREEF                | III | 15 | PASS |
| 50 | 14E31A0156 | TINGILKAR VISHAL                 | III | 14 | PASS |
| 51 | 14E31A0157 | VAISHNAVI UPADHYAY               | III | 18 | PASS |
| 52 | 14E31A0158 | VANAPARTHI SANTHOSH VARMA        | III | 15 | PASS |
| 53 | 14E31A0159 | VEMULA AVINASH                   | III | 16 | PASS |
| 54 | 13E31A0102 | ABDUL RAHMAN BIN HASSAN AL YAFAI | III | 15 | PASS |
| 55 | 15E35A0101 | ALTAf AHMED                      | III | 15 | PASS |
| 56 | 15E35A0102 | B SAI KRISHNA                    | III | 18 | PASS |
| 57 | 15E35A0103 | BORRA RAGHU RAM                  | III | 15 | PASS |
| 58 | 15E35A0104 | GANGULA RATHNA KUMAR             | III | 16 | PASS |
| 59 | 15E35A0105 | KASTHOORI VENKATAKRISHNA         | III | 15 | PASS |
| 60 | 15E35A0106 | MD JUNED                         | III | 16 | PASS |
| 61 | 15E35A0107 | METHUKU SAGAR REDDY              | III | 15 | PASS |
| 62 | 15E35A0108 | MOHAMMED NADEEMUDDIN             | III | 16 | PASS |
| 63 | 15E35A0109 | NALLA SHESHU VARDHAN REDDY       | III | 15 | PASS |
| 64 | 15E35A0110 | NALLAPU VEERA HANUMANATHA RAO    | III | 14 | PASS |
| 65 | 15E35A0111 | VANKUNAVATH PRAVEEN              | III | 18 | PASS |
| 66 | 15E35A0112 | V KAVITHA                        | III | 15 | PASS |
| 67 | 13E31A0105 | AMBALA RAJKUMAR                  | III | 16 | PASS |



*K. Srinivas*  
PRINCIPAL  
MAHAVEER  
INSTITUTE OF SCIENCE & TECHNOLOGY  
Bandlaguda, Hyd-500 005.

Vysapuri, Bandlaguda Post:Kashavpuri,  
Hyderabad-500 005, Telangana INDIA  
Tel: 040-64566979,20020773, Fax: 040-24455003  
E-mail: [principal.mahaveer@gmail.com](mailto:principal.mahaveer@gmail.com),  
Website: [www.mist.ac.in](http://www.mist.ac.in),

**MAHAVEER**

INSTITUTE OF SCIENCE & TECHNOLOGY

Approved by AICTE, Affiliated to JNTUH, Hyd.



Etabs course  
Summary

Department of Civil Engineering

- Use ETABS for daily working process.
- Navigate throughout ETABS using major navigating tools.
- Understand the concept and techniques to draw.
- Create multiple designs using several of tools.
- Create layers to control the objects' visibility.
- Explain drawing using annotations.
- To use constraint for certain design.

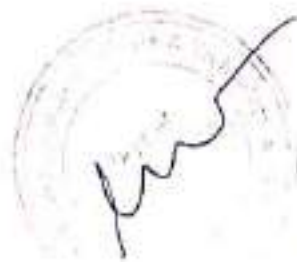

*K. Srinivas*  
PRINCIPAL  
MAHAVEER  
INSTITUTE OF SCIENCE & TECHNOLOGY  
Bandlaguda, Hyderabad.

Vysapuri, Bandlaguda Post:Keshavgi,  
Hyderabad-500 005, Telangana INDIA  
Tel: 040-64596979,20020773,,Fax: 040-24455003  
E-mail: [principal.mahaveer@gmail.com](mailto:principal.mahaveer@gmail.com),  
Website: [www.mist.ac.in](http://www.mist.ac.in),

**MAHAVEER**

INSTITUTE OF SCIENCE & TECHNOLOGY

Approved by AICTE, Affiliated to JNTUH,Hyd.



## CERTIFICATE OF COURSE COMPLETION

This certificate is presented to \_\_\_\_\_ of MIST,who  
has successfully completed technical training course on “ETABS”  
held from \_\_\_\_\_ to \_\_\_\_\_ and found the student  
performance to be excellent.



ESTD : 2001

CH.SWETHAMBER

HOD

Civil Department

*Kishor*  
PRINCIPAL  
MAHAVEER  
INSTITUTE OF SCIENCE & TECHNOLOGY  
Bandlaguda, Hyderabad-500 005.





Vysapuri, Bandlaguda Post: Keshavpet,  
Hyderabad-500 015, Telangana INDIA  
Tel: 040-64596978, 20020773, Fax: 040-24458003  
E-mail: [principal.mahaveer@gmail.com](mailto:principal.mahaveer@gmail.com)  
Website: [www.mist.ac.in](http://www.mist.ac.in)

**MAHAVEER**  
INSTITUTE OF SCIENCE & TECHNOLOGY  
Approved by AICTE, Affiliated to JNTUH, Hyd.



## PROPOSAL LETTER

Hyderabad,

20/07/2016.

To,  
The principal,  
MIST,  
Hyderabad.

Sub: Proposal for three weeks workshop on GEO5-Reg.

Dear Sir,

We are working as asst professor in the department of CIVIL ENGINEERING. Sir, we are going to conduct three weeks workshop on GEO5. We require your approval to go head for further proceeding and hope to get an opportunity to serve you the best .

With thanks and Regards



*Ashty*

PRINCIPAL  
"MAHAVEER"  
INSTITUTE OF SCIENCE & T  
Bandlaguda, Hyd-500 015

From,  
Civil Department  
Mist,  
Bandlaguda,  
Hyderabad.

Vysapuri, Bandlaguda Post:Keshavgiri,  
Hyderabad-500 005, Telangana INDIA  
Tel: 040-64556979,20020773, Fax: 040-24455003  
E-mail: [principal.mahaveer@gmail.com](mailto:principal.mahaveer@gmail.com),  
Website: [www.mist.ac.in](http://www.mist.ac.in),

**MAHAVEER**  
INSTITUTE OF SCIENCE & TECHNOLOGY  
Approved by AICTE, Affiliated to JNTUH,Hyd.



Date: 01.08.2016

**CIRCULAR**

Technical Training for IV B. Tech students are starting from 20<sup>TH</sup> AUG, 2016 onwards. All HODs and Placements coordinators have to manage the trainings and ensure 95% attendance all through the sessions,

All Mentors need to send the compiled feedback report to CH. Swethamber , HOD at [e3hod.civil@gmail.com](mailto:e3hod.civil@gmail.com) daily.

Agenda: 1. Introduction to GEOS SOFTWARE.

CH.SWETHAMBER  
HOD

Design by: B.RAMANA KUMAR  
K.MAHESH KUMAR



*Kishu*  
PRINCIPAL  
MAHAVEER  
INSTITUTE OF SCIENCE & TECHNOLOGY  
Bandlaguda, Hyderabad

Vysapuri, Bandlaguda Post:Kashavgiri,  
Hyderabad-500 005, Telangana INDIA  
Tel: 040-64506979,20020773, Fax: 040-24455003  
Email: [principal.mahaveer@gmail.com](mailto:principal.mahaveer@gmail.com),  
Website: [www.mist.ac.in](http://www.mist.ac.in),

**MAHAVEER**  
INSTITUTE OF SCIENCE & TECHNOLOGY  
Approved by AICTE, Affiliated to JNTUH,Hyd.



## GEO5 SOFTWARE

### 1: Getting Started with GEO5

- 1) Design of a cantilever wall
- 2) Verification of a gravity wall
- 3) Design of a non-anchored retaining wall
- 4) Design of an anchored retaining wall
- 5) Verification of a multi anchored wall
- 6) Slope stability analysis
- 7) Design of the geometry of a spread footing
- 8) Settlement of a spread footing
- 9) Analysis of a consolidation under embankment
- 10) Pile foundations-introduction



*Kishu*

PRINCIPAL  
**MAHAVEER**

INSTITUTE OF SCIENCE & TECHNOLOGY  
Bandlaguda, Hyderabad



Vysapuri, Bandlaguda Post:Keshavgi,  
Hyderabad-506 005, Telangana INDIA  
Tel: 040-64598979,20020773, Fax: 040-24455003  
E-mail: [principal.mahaveer@gmail.com](mailto:principal.mahaveer@gmail.com),  
Website: [www.mist.ac.in](http://www.mist.ac.in),

**MAHAVEER**

INSTITUTE OF SCIENCE & TECHNOLOGY  
Approved by AICTE, Affiliated to JNTUH,Hyd.



| GEO5 SOFTWARE COURSE<br>CIVIL ENGINEERING |                 |                            |      |
|---|-----------------|----------------------------|------|
| B.TECH IV YEAR I SEM 2016-17 BATCH        |                 |                            | YEAR |
| S.No                                      | Hall Ticket No. | Name of the Candidate      | IV   |
| 1   | 13E31A0101      | A AAKASH GOUD              | IV   |
| 2   | 13E31A0103      | AKKINAPPELLY ARAVIND       | IV   |
| 3   | 13E31A0104      | ALE SANATHI KUMAR          | IV   |
| 4   | 13E31A0106      | ANDRALA VIJAYA             | IV   |
| 5   | 13E31A0107      | B SRIVANI                  | IV   |
| 6   | 13E31A0108      | BATTHULA VINAY             | IV   |
| 7   | 13E31A0109      | BEKKAM SHARAN KUMAR        | IV   |
| 8   | 13E31A0110      | CHIENNADI KAVYASREE        | IV   |
| 9   | 13E31A0111      | CHITYALA KARNAKAR          | IV   |
| 10  | 13E31A0112      | CHUKKA RANJITHKUMAR        | IV   |
| 11  | 13E31A0113      | DABBA ROHITHI              | IV   |
| 12  | 13E31A0114      | DIVITI DEEKSHA             | IV   |
| 13  | 13E31A0115      | G. MAHESH KUMAR            | IV   |
| 14  | 13E31A0116      | GOLI SANDEEP SHAHLI        | IV   |
| 15  | 13E31A0117      | GOPIREDDY SOMASHEKAR REDDY | IV   |
| 16  | 13E31A0118      | GURRAM RAGHAVENDHAR        | IV   |
| 17  | 13E31A0119      | IRFAN AHMED KHAN           | IV   |
| 18  | 13E31A0120      | MD FAIYAZ                  | IV   |



*K. S. S. S.*  
PRINCIPAL  
**MAHAVEER**  
INSTITUTE OF SCIENCE & TECH  
Bandlaguda, Hyd-506 005.

|    |            |                          |    |
|----|------------|--------------------------|----|
| 19 | 13E31A0121 | KARUMANCHI VAMSI KRISHNA | IV |
| 20 | 13E31A0122 | KASTURI RAKESH           | IV |
| 21 | 13E31A0123 | KONDABATHULA RAJESH      | IV |
| 22 | 13E31A0124 | KOUSALYA                 | IV |
| 23 | 13E31A0125 | MADHAVI KISHORE KUMAR    | IV |
| 24 | 13E31A0126 | MADDOORI VIJAY           | IV |
| 25 | 13E31A0127 | MD MASROOR ALAM          | IV |
| 26 | 13E31A0128 | MEDIPELLY VINOD REDDY    | IV |
| 27 | 13E31A0129 | MEGHAVATHI RENUKA        | IV |
| 28 | 13E31A0130 | MENDE SUSHANTH ENOCH     | IV |
| 29 | 13E31A0131 | MENGA NAVEEN KUMAR       | IV |
| 30 | 13E31A0132 | MIRZA MOHAMMED ALI BAIG  | IV |
| 31 | 13E31A0133 | MOHAMMED ILYASUDDIN      | IV |
| 32 | 13E31A0134 | MOHAMMED MOUAZZAM        | IV |
| 33 | 13E31A0135 | MOHD ANAS RAFEEQ         | IV |
| 34 | 13E31A0136 | MOHD SHARAZ AHMED        | IV |
| 35 | 13E31A0137 | MUJGELA VISHWATEJA       | IV |
| 36 | 13E31A0138 | MUSKU SANTOSHI           | IV |
| 37 | 13E31A0139 | NALUVALA NAGESH KUMAR    | IV |
| 38 | 13E31A0140 | PERIKA KRISHINA          | IV |
| 39 | 13E31A0141 | PRAKASHI PALLE           | IV |
| 40 | 13E31A0142 | R.VINOD KUMAR            | IV |
| 41 | 13E31A0143 | S K SHANAWAZ             | IV |
| 42 | 13E31A0144 | S SHIVA KUMAR            | IV |
| 43 | 13E31A0145 | SHANEGALA KAPIL KUMAR    | IV |
| 44 | 13E31A0146 | SHIV SHANKER SINGH       | IV |



*K. S. S.*  
**PRINCIPAL**  
**MAHAVEER**  
 INSTITUTE OF SCIENCE & TECH. 751  
 Bandlaguda, Hyd-500 605.

|    |            |                         |    |
|----|------------|-------------------------|----|
| 45 | 13E31A0147 | SHIVARATRI DIVYA        | IV |
| 46 | 13E31A0148 | SYED AHAMED MAIBOOB ALI | IV |
| 47 | 13E31A0150 | ULLI SAI KIRAN          | IV |
| 48 | 13E31A0151 | VEERABOINA SRINIVAS     | IV |
| 49 | 13E31A0152 | VEESAM SUSMITHA         | IV |
| 50 | 14E35A0101 | BIRADHAR ESHWAR RAO     | IV |
| 51 | 14E35A0102 | AKULA MAHESH            | IV |
| 52 | 14E35A0103 | MD. IMTHIYAZ HUSSAIN    | IV |
| 53 | 14E35A0104 | NUNAVATHI MOTHILAL      | IV |
| 54 | 14E35A0105 | BANDHARABOINA RAMESH    | IV |



*K. Mahaveer*  
**PRINCIPAL**  
**MAHAVEER**  
 INSTITUTE OF SCIENCE & TECHNOLOGY  
 Bandlaguda, Hyd-500 005



**MAHAVEER INSTITUTE OF SCIENCE & TECHNOLOGY, HYDERABAD**

**CIVIL ENGINEERING STUDENTS ATTENDANCE**

**B.TECH IV YEAR I SEM 2016-2017 BATCH ( Date :20-8-2016 to 31-8-2016)**

| S.No | Hall Ticket No | Name of the Candidate    | 1 | 2 | 3 | 4 | 5 | 6 | 7 | 8 | 9 | 10 |
|------|----------------|--------------------------|---|---|---|---|---|---|---|---|---|----|
| 1    | 13E31A0101     | A AAKASH GOUD            | P | P | P | P | A | P | P | P | A | P  |
| 2    | 13E31A0103     | AKKINAPPELLY ARAVIND     | P | P | P | P | P | P | P | A | A | P  |
| 3    | 13E31A0104     | ALE SANATH KUMAR         | P | P | P | P | P | P | P | P | P | A  |
| 4    | 13E31A0106     | ANDRALA VIJAYA           | P | P | P | P | P | A | P | P | P | P  |
| 5    | 13E31A0107     | B SRIVANI                | P | P | P | P | P | P | P | P | A | A  |
| 6    | 13E31A0108     | BATTHULA VINAY           | P | P | P | P | P | P | P | P | P | P  |
| 7    | 13E31A0109     | BEKKAM SHARAN KUMAR      | P | P | P | P | P | P | A | P | A | P  |
| 8    | 13E31A0110     | CHENNADI KAVYASREE       | P | P | P | P | P | P | P | P | A | P  |
| 9    | 13E31A0111     | CHITYALA KARNAKAR        | P | P | P | P | P | P | P | A | P | P  |
| 10   | 13E31A0112     | CHUKKA RANJITHKUMAR      | P | P | P | P | P | P | A | P | P | P  |
| 11   | 13E31A0113     | DABBA ROHITH             | P | P | P | P | P | P | P | P | P | P  |
| 12   | 13E31A0114     | DIVITI DEEKSHA           | P | P | P | P | P | P | P | P | P | P  |
| 13   | 13E31A0115     | G. MAHESH KUMAR          | P | P | P | P | P | P | P | P | P | P  |
| 14   | 13E31A0116     | GOLI SANDEEP SHAHIL      | P | P | P | P | P | P | P | P | P | P  |
|      |                | GOPIREDDY SOMASHEKAR     | P | P | P | P | P | P | P | A | P | P  |
| 15   | 13E31A0117     | REDDY                    |   |   |   |   |   |   |   |   |   |    |
| 16   | 13E31A0118     | GURRAM RAGHAVENDIAR      | P | P | P | P | P | P | A | P | P | P  |
| 17   | 13E31A0119     | IRFAN AHMED KHAN         | P | P | P | P | P | P | P | P | A | P  |
| 18   | 13E31A0120     | MD FAIYAZ                | P | P | P | P | P | P | P | P | P | A  |
| 19   | 13E31A0121     | KARUMANCHI VAMSI KRISHNA | P | P | P | P | P | P | A | P | P | P  |
| 20   | 13E31A0122     | KASTURI RAKESH           | P | P | P | P | P | P | P | P | P | P  |
| 21   | 13E31A0123     | KONDABATHULA RAJESH      | P | P | P | P | P | P | P | P | P | P  |
| 22   | 13E31A0124     | KOUSALYA                 | P | P | P | P | P | P | P | A | P | P  |
| 23   | 13E31A0125     | MADHAVI KISHORE KUMAR    | P | P | P | P | P | P | P | P | P | P  |
| 24   | 13E31A0126     | MADDOORI VIJAY           | P | P | P | P | P | P | P | A | P | P  |



**PRINCIPAL**  
**MAHAVEER**  
INSTITUTE OF SCIENCE & TECHNOLOGY  
Bandlaguda, Hyd-500 005.





Vysapuri, Bandlaguda Post:Koshavglri,  
Hyderabad-500 005, Telangana INDIA  
Tel: 040-64595979,20020773, Fax: 040-24455003  
E-mail: [principal.mahaveer@gmail.com](mailto:principal.mahaveer@gmail.com),  
Website: [www.mist.ac.in](http://www.mist.ac.in),

**MAHAVEER**  
INSTITUTE OF SCIENCE & TECHNOLOGY  
Approved by AICTE, Affiliated to JNTUH,Hyd.



Technical Training Exam on GEO5 Software  
(A.Y-2016-17)

2x10=20 Marks

Answer All the Questions

- 1.What is GEO5 SOFTWARE ?
- 2.What are the Uses of The GEO5 SOFTWARE ?.

  
K. S. S. S.  
PRINCIPAL  
MAHAVEER  
INSTITUTE OF SCIENCE & TECHNOLOGY  
Bandlaguda, Hyd-500 005



Vysapuri, Bandlaguda Post:Koshavglri,  
Hyderabad-500 005, Telangana INDIA  
Tel: 040-64596979,20920773, Fax: 040-24455003  
E-mail: [principal.mahaveer@gmail.com](mailto:principal.mahaveer@gmail.com),  
Website: [www.mist.ac.in](http://www.mist.ac.in),

# MAHAVEER

INSTITUTE OF SCIENCE & TECHNOLOGY  
Approved by AICTE, Affiliated to JNTUH,Hyd.



## GEO5 SOFTWARE COURSE CIVIL ENGINEERING

### B.TECH IV YEAR I SEM 2016-17 BATCH

| S.No | Hall Ticket No. | Name of the Candidate      | YEAR | Marks | Pass/F |
|------|-----------------|----------------------------|------|-------|--------|
| 1    | 13E31A0101      | A AAKASH GOUD              | IV   | 16    | Pass   |
| 2    | 13E31A0103      | AKKINAPPELLY ARAVIND       | IV   | 15    | Pass   |
| 3    | 13E31A0104      | ALE SANATH KUMAR           | IV   | 14    | Pass   |
| 4    | 13E31A0106      | ANDRALA VIJAYA             | IV   | 15    | Pass   |
| 5    | 13E31A0107      | B SRIVANI                  | IV   | 12    | Pass   |
| 6    | 13E31A0108      | BATTHULA VINAY             | IV   | 13    | Pass   |
| 7    | 13E31A0109      | BEKKAM SHARAN KUMAR        | IV   | 13    | Pass   |
| 8    | 13E31A0110      | CHENNADI KAVYASREE         | IV   | 14    | Pass   |
| 9    | 13E31A0111      | CHITYALA KARNAKAR          | IV   | 16    | Pass   |
| 10   | 13E31A0112      | CHUKKA RANJITHKUMAR        | IV   | 15    | Pass   |
| 11   | 13E31A0113      | DABBA ROHITH               | IV   | 15    | Pass   |
| 12   | 13E31A0114      | DIVITI DEEKSHA             | IV   | 14    | Pass   |
| 13   | 13E31A0115      | G. MAHESH KUMAR            | IV   | 13    | Pass   |
| 14   | 13E31A0116      | GOLI SANDEEP SHAIKH        | IV   | 14    | Pass   |
| 15   | 13E31A0117      | GOPIREDDY SOMASHEKAR REDDY | IV   | 12    | Pass   |
| 16   | 13E31A0118      | GURRAM RAGHAVENDHAR        | IV   | 15    | Pass   |
| 17   | 13E31A0119      | IRFAN AHMED KHAN           | IV   | 14    | Pass   |
| 18   | 13E31A0120      | MD FAIYAZ                  | IV   | 15    | Pass   |



*K. Srinivas*

PRINCIPAL  
MAHAVEER  
INSTITUTE OF SCIENCE & TECHNOLOGY  
Bandlaguda, Hyd-500 005.

|    |            |                          |    |    |      |
|----|------------|--------------------------|----|----|------|
| 19 | 13E31A0121 | KARUMANCHI VAMSI KRISHNA | IV | 14 | Pass |
| 20 | 13E31A0122 | KASTURI RAKESH           | IV | 12 | Pass |
| 21 | 13E31A0123 | KONDABATHULA RAJESH      | IV | 15 | Pass |
| 22 | 13E31A0124 | KOUSALYA                 | IV | 16 | Pass |
| 23 | 13E31A0125 | MADHAVI KISHORE KUMAR    | IV | 14 | Pass |
| 24 | 13E31A0126 | MADDOORI VIJAY           | IV | 15 | Pass |
| 25 | 13E31A0127 | MD MASROOR ALAM          | IV | 14 | Pass |
| 26 | 13E31A0128 | MEDIPELLY VINOD REDDY    | IV | 15 | Pass |
| 27 | 13E31A0129 | MEGHAVATHI RENUKA        | IV | 16 | Pass |
| 28 | 13E31A0130 | MENDE SUSHANTH ENOCH     | IV | 15 | Pass |
| 29 | 13E31A0131 | MENGA NAVEEN KUMAR       | IV | 14 | Pass |
| 30 | 13E31A0132 | MIRZA MOHAMMED ALI BAIG  | IV | 15 | Pass |
| 31 | 13E31A0133 | MOHAMMED ILYASUDDIN      | IV | 12 | Pass |
| 32 | 13E31A0134 | MOHAMMED MOUAZZAM        | IV | 13 | Pass |
| 33 | 13E31A0135 | MOHD ANAS RAFEEQ         | IV | 14 | Pass |
| 34 | 13E31A0136 | MOHD SHARAZ AHMED        | IV | 12 | Pass |
| 35 | 13E31A0137 | MUJIGELA VISHWATEJA      | IV | 16 | Pass |
| 36 | 13E31A0138 | MUSKU SANTOSH            | IV | 14 | Pass |
| 37 | 13E31A0139 | NALUVALA NAGESH KUMAR    | IV | 15 | Pass |
| 38 | 13E31A0140 | PERIKA KRISHNA           | IV | 13 | Pass |
| 39 | 13E31A0141 | PRAKASHI PALLE           | IV | 12 | Pass |
| 40 | 13E31A0142 | R.VINOD KUMAR            | IV | 13 | Pass |
| 41 | 13E31A0143 | S K SHANAWAZ             | IV | 15 | Pass |
| 42 | 13E31A0144 | S SHIVA KUMAR            | IV | 16 | Pass |
| 43 | 13E31A0145 | SHANEGALA KAPIL KUMAR    | IV | 14 | Pass |
| 44 | 13E31A0146 | SHIV SHANKER SINGH       | IV | 12 | Pass |



*Kanish*  
**PRINCIPAL**  
**MAHAVEER**  
 INSTITUTE OF SCIENCE & TECH: 57  
 Bandlaguda, Hyd-500 005.

|    |            |                         |    |    |      |
|----|------------|-------------------------|----|----|------|
| 45 | 13E31A0147 | SHIVARATRI DIVYA        | IV | 13 | Pass |
| 46 | 13E31A0148 | SYED AHAMED MAHBOOB ALI | IV | 13 | Pass |
| 47 | 13E31A0150 | ULLI SAI KIRAN          | IV | 15 | Pass |
| 48 | 13E31A0151 | VEERABOINA SRINIVAS     | IV | 16 | Pass |
| 49 | 13E31A0152 | VEESAM SUSMITHA         | IV | 14 | Pass |
| 50 | 14E35A0101 | BIRADHAR ESHWAR RAO     | IV | 15 | Pass |
| 51 | 14E35A0102 | AKULA MAHESH            | IV | 13 | Pass |
| 52 | 14E35A0103 | MD. IMTHIYAZ HUSSAIN    | IV | 12 | Pass |
| 53 | 14E35A0104 | NUNAVATH MOTHILAL       | IV | 12 | Pass |
| 54 | 14E35A0105 | BANDHARABOINA RAMESH    | IV | 15 | Pass |



*Mahaveer*  
**PRINCIPAL**  
**MAHAVEER**  
 INSTITUTE OF SCIENCE & TECHNOLOGY  
 Bandlaguda, Hyd-500 005.



Vysapuri, Bandlaguda Post:Keshavgiri,  
Hyderabad-500 005, Telangana INDIA  
Tel: 040-64596979,20020773,, Fax: 040-24455003  
E-mail: [principal.mahaveer@gmail.com](mailto:principal.mahaveer@gmail.com),  
Website: [www.mist.ac.in](http://www.mist.ac.in),

**MAHAVEER**  
INSTITUTE OF SCIENCE & TECHNOLOGY  
Approved by AICTE, Affiliated to JNTUH,Hyd.



## GEO5 COURSE

### Summery

### Department of Civil Engineering

- Use GEO5 for daily working process.
- Navigate throughout GEO5 using major navigating tools.
- Understand the concept and techniques to draw.
- Create multiple designs using several of tools.
- Create layers to control the objects' visibility.
- Explain drawing using annotations.
- Plot or print the drawing by scale.
- To use constraint for certain design.



*Principal*

PRINCIPAL  
**MAHAVEER**  
INSTITUTE OF SCIENCE & TECH  
Bandlaguda, Hyd-500 005

Vysapuri, Bandlaguda Post:Kothavaram,  
Hyderabad-500 005, Telangana INDIA  
Tel: 040-64596979,20020773, Fax: 040-24455003  
E-mail: [principal.mahaveer@gmail.com](mailto:principal.mahaveer@gmail.com),  
Website: [www.mist.ac.in](http://www.mist.ac.in),

**MAHAVEER**  
INSTITUTE OF SCIENCE & TECHNOLOGY  
Approved by AICTE, Affiliated to JNTU,Hyd.



## CERTIFICATE OF COURSE COMPLETION

This certificate is presented to \_\_\_\_\_ of MIST, who has successfully completed technical training course on "GEO5" held from \_\_\_\_\_ to \_\_\_\_\_ and found the student performance to be excellent.



ESTD : 2001

CH.SWETHAMBER

HOD

Civil Department



*K. S. S.*

PRINCIPAL  
MAHAVEER

INSTITUTE OF SCIENCE & TECHNOLOGY  
bandlaguda, Hyd 500 005.

Vysapuri, Bandlaguda Post:Keshavgiri,  
Hyderabad-500 005, Telangana INDIA  
Tel: 040-54596979,20020773, Fax: 040-24455003  
E-mail: [principal\\_mahaveer@gmail.com](mailto:principal_mahaveer@gmail.com),  
Website: [www.mist.ac.in](http://www.mist.ac.in),

**MAHAVEER**  
INSTITUTE OF SCIENCE & TECHNOLOGY  
Approved by AICTE, Affiliated to JNTUH,Hyd.



## PROPOSAL LETTER

Hyderabad,

10/03/2016.

To

The principal,

MIST,

Hyderabad.

Sub: Proposal for three weeks workshop on STADD PROVIS-Reg.

Dear Sir,

We are working as asst professor in the department of CIVIL ENGINEERING. Sir, we are going to conduct three weeks workshop on STADD PROVIS. We require your approval to go head for further proceeding and hope to get an opportunity to serve you the best .

With thanks and Regards

Civil Department,

From,

Mist,  
Bandlaguda,  
Hyderabad.



*Kishor*  
PRINCIPAL  
MAHAVEER  
INSTITUTE OF SCIENCE & TECHNOLOGY  
Bandlaguda, Hyderabad



Vysapuri, Bandlaguda Post; Keshavnagar,  
Hyderabad-500 065, Telangana INDIA  
Tel: 040-64596979, 20020773, Fax: 040-24455003  
E-mail: [principal.mahaveer@gmail.com](mailto:principal.mahaveer@gmail.com),  
Website: [www.mist.ac.in](http://www.mist.ac.in),

**MAHAVEER**  
INSTITUTE OF SCIENCE & TECHNOLOGY  
Approved by AICTE, Affiliated to JNTUH, Hyd.



Date: 14.03.2016

**CIRCULAR**

Technical Training for IV B. Tech students are starting from 14<sup>th</sup> March, 2016 onwards.  
All HODs and Placements coordinators have to manage the trainings and ensure 95% attendance all through the sessions.

All Mentors need to send the compiled feedback report to HOD at [e3hod.civil@gmail.com](mailto:e3hod.civil@gmail.com) daily.

Agenda: 1. Introduction to STAAD .Provi8.

DESIGNED BY

CH. SWETHAMBER  
GARUNA

CH. SWETHAMBER  
HOD

PRINCIPAL  
MAHAVEER  
INSTITUTE OF SCIENCE & TECHNOLOGY  
Bandlaguda, Hyd-500 065.





## STAAD.ProVi8 SYLLABUS

### Chapter 1: Before you start using Bentley STAAD.ProVi8

- Understanding Unit Conversion Tables
- Overview of Structural Design & Analysis
- Stresses and Strains
- Shear Force & Bending Moment Diagrams
- Introduction to Types of Structures
- Overview of Steel, Concrete and Foundation Design
- Introduction to Finite Element Analysis

### Chapter 2: Introduction to STAAD.ProVi8

- About Bentley STAAD.Pro
- Starting STAAD.Pro
- Graphical User Interface
- Starting a New Project
- Working with User Interface:
  - Menu Bars
  - Tool Bars
  - Tabs
  - Snap Node / Beam Window
  - Data Area
  - Main Window
- Opening and Existing Project
- Saving a Project
- Configuring Units
- Keyboard Shortcuts
- Importing Model in STAAD.Pro
- Coordinate Systems

### Chapter 3: Structural Modeling

- Adding Beams using Tools
- Creating Beams (Collinear, Along Axes)
- Creating Plates
- Creating Surfaces
- Creating Solid Elements
- Creating Structure
- Stretching and Intersecting Members
- Merging Members and Nodes
- Renumbering Nodes, Members and Elements
- Splitting and Breaking Beams
- Cutting Sections



*K. Mahaveer*  
PRINCIPAL  
MAHAVEER  
INSTITUTE OF SCIENCE & TECHNOLOGY  
Bandlaguda, Hyderabad-500 005

#### Chapter 4: Material Constants and Section Properties

- a. MaterialConstants
- b. Creating and Editing MaterialProperties
- c. Assigning Materials to theStructure
- d. OrthotropicMaterials
- e. SectionProperties
  - Prismatic Sections
  - TaperedSections
  - Steel Sections
  - Steel Joist and JoistGirders
  - Plate/SurfaceThickness

#### Chapter 5: Member Specifications and Supports

- a. NodeSpecification
- b. MemberSpecifications
  - Release
  - Offset
  - Property Reductionfactors
  - Cable
  - Truss
  - Compression
  - Tension
  - Inactive
- c. PlateSpecifications
  - Release
  - Ignore InplaneRotation
  - PlaneStress
- d. Supports:
  - Fixed
  - Pinned
  - FixedBut
  - Enforced
  - EnforcedBut
  - MultilinearSpring
  - Foundation
  - Inclined
  - Tension/Compression OnlySprings

#### Chapter 6: Loads

- a. Types of Loads: Selfweight, Nodal, Member, Area, Floor, Plate, Surface andSolid,
- b. LoadGeneration
- c. LoadCombinations

#### Chapter 7: Performing Analysis

- a. PreAnalysis
  - ProblemStatistics
  - JointCoordinates
  - MemberInformation
  - MaterialProperties
  - SupportInformation
  - Element & SolidInformation
- b. PerformingAnalysis

#### Chapter 8: Post Processing & Report Creation

- a. Post AnalysisPrint
  - LoadLists
  - JointDisplacement



*Handwritten signature in blue ink.*

PRINCIPAL  
MAHAVEER

INSTITUTE OF SCIENCE & TECHNOLOGY  
Bandlaguda, Hyd-500 005.



- MemberForces
  - SupportReactions
  - CG
  - ModeShapes
  - SectionDisplacement
  - Analysis Results
  - MemberStresses
  - ElementForces/Stresses
- b. ViewingResults  
c. OutputFile  
d. Post ProcessingMode

#### Chapter 9: Analysis Case Studies / Workshops

- a. RCCDesign&Analysis(BeamsandColumns)
- b. SteelDesign&Analysis(FramesandTrusses)
- c. MiscellaneousAnalysis
- d. Practice examples forStudents



*Abhishek*  
PRINCIPAL  
MALAVIYA  
INSTITUTE OF SCIENCE & TECHNOLOGY  
Bandlaguda, Hyd-500 005.



**Department of Civil Engineering**  
**STAAD.ProV8 Technical Training student attendance list 2016-17**

| SL.NO. | ROLL NO.   | NAME OF THE STUDENT        | YEAR |
|--------|------------|----------------------------|------|
| 1      | 13E31A0101 | A AAKASH GOUD              | IV   |
| 2      | 13E31A0103 | AKKINAPPELLY ARAVIND       | IV   |
| 3      | 13E31A0104 | ALE SANATH KUMAR           | IV   |
| 4      | 13E31A0106 | ANDRALA VIJAYA             | IV   |
| 5      | 13E31A0107 | B SRIVANI                  | IV   |
| 6      | 13E31A0108 | BATTHULA VINAY             | IV   |
| 7      | 13E31A0109 | BEKKAM SHARAN KUMAR        | IV   |
| 8      | 13E31A0110 | CHENNADI KAVYASREE         | IV   |
| 9      | 13E31A0111 | CHITYALA KARNAKAR          | IV   |
| 10     | 13E31A0112 | CHUKKA RANJITHKUMAR        | IV   |
| 11     | 13E31A0113 | DABBA ROHITH               | IV   |
| 12     | 13E31A0114 | DIVITI DEEKSHA             | IV   |
| 13     | 13E31A0115 | G. MAHESH KUMAR            | IV   |
| 14     | 13E31A0116 | GOLI SANDEEP SHAHIL        | IV   |
| 15     | 13E31A0117 | GOPIREDDY SOMASHEKAR REDDY | IV   |
| 16     | 13E31A0118 | GURRAM RAGHAVENDHAR        | IV   |
| 17     | 13E31A0119 | IRFAN AHMED KHAN           | IV   |
| 18     | 13E31A0120 | MD FAIAZ                   | IV   |
| 19     | 13E31A0121 | KARUMANCHI VAMSI KRISHNA   | IV   |
| 20     | 13E31A0122 | KASTURI RAKESH             | IV   |
| 21     | 13E31A0123 | KONDABATHULA RAJESH        | IV   |
| 22     | 13E31A0124 | KOUSALYA                   | IV   |
| 23     | 13E31A0125 | MADHAVI KISHORE KUMAR      | IV   |
| 24     | 13E31A0126 | MADDOORI VIJAY             | IV   |
| 25     | 13E31A0127 | MD MASROOR ALAM            | IV   |
| 26     | 13E31A0128 | MEDIPELLY VINOD REDDY      | IV   |
| 27     | 13E31A0129 | MEGHAVATH RENUKA           | IV   |
| 28     | 13E31A0130 | MENDE SUSHANTH ENOCH       | IV   |
| 29     | 13E31A0131 | MENGA NAVEEN KUMAR         | IV   |
| 30     | 13E31A0132 | MIRZA MOHAMMED ALI BAIG    | IV   |
| 31     | 13E31A0133 | MOHAMMED ILYASUDDIN        | IV   |
| 32     | 13E31A0134 | MOHAMMED MOUZZAM           | IV   |
| 33     | 13E31A0135 | MOHD ANAS RAFEEQ           | IV   |
| 34     | 13E31A0136 | MOHD SHAROF AHMED          | IV   |
| 35     | 13E31A0137 | MUNIGETA VISHWATEJA        | IV   |
| 36     | 13E31A0138 | MUSKUN SANTOSH             | IV   |

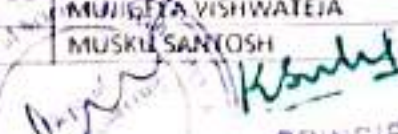
  
 PRINCIPAL  
**MAHAVEER**  
 INSTITUTE OF SCIENCE & TECHNOLOGY  
 Bandlaguda, Hyd-500 005.

|    |            |                         |    |
|----|------------|-------------------------|----|
| 37 | 13E31A0139 | NALLIVALA NAGESH KUMAR  | IV |
| 38 | 13E31A0140 | PERIKA KRISHNA          | IV |
| 39 | 13E31A0141 | PRAKASH PALLE           | IV |
| 40 | 13E31A0142 | R.VINOD KUMAR           | IV |
| 41 | 13E31A0143 | S K SHANAWAZ            | IV |
| 42 | 13E31A0144 | S SHIVA KUMAR           | IV |
| 43 | 13E31A0145 | SHANEGALA KAPIL KUMAR   | IV |
| 44 | 13E31A0146 | SHIV SHANKER SINGH      | IV |
| 45 | 13E31A0147 | SHIVARATRI DIVYA        | IV |
| 46 | 13E31A0148 | SYED AHAMED MAHBOOB ALI | IV |
| 47 | 13E31A0150 | ULLI SAI KIRAN          | IV |
| 48 | 13E31A0151 | VEERABOINA SRINIVAS     | IV |
| 49 | 13E31A0152 | VEESAM SUSMITHA         | IV |
| 50 | 14E35A0101 | BIRADHAR ESHWAR RAO     | IV |
| 51 | 14E35A0102 | AKULA MAHESH            | IV |
| 52 | 14E35A0103 | MD. IMTHIYAZ HUSSAIN    | IV |
| 53 | 14E35A0104 | NUNAVATH MOTHILAL       | IV |
| 54 | 14E35A0105 | BANDHARABOINA RAMESH    | IV |



*Kishor*  
 PRINCIPAL  
 M. JAVEER  
 INSTITUTE OF SCIENCE & TECHNOLOGY  
 Bandlaguda, Hyd 500 005.





## Department of Civil Engineering STAAD.ProVi8 Technical Training student attendance list 2016-17

| SNO | Roll No    | Name of the student        | YEAR | MARKS | PASS/FAIL |
|-----|------------|----------------------------|------|-------|-----------|
| 1   | 13E31A0101 | A AAKASH GOUD              | IV   | 16    | PASS      |
| 2   | 13E31A0103 | AKKINAPPELLY ARAVIND       | IV   | 16    | PASS      |
| 3   | 13E31A0104 | ALE SANATH KUMAR           | IV   | 12    | PASS      |
| 4   | 13E31A0106 | ANDRALA VIJAYA             | IV   | 12    | PASS      |
| 5   | 13E31A0107 | B SRIVANI                  | IV   | 16    | PASS      |
| 6   | 13E31A0108 | BATTHULA VINAY             | IV   | 16    | PASS      |
| 7   | 13E31A0109 | BEKKAM SHARAN KUMAR        | IV   | 16    | PASS      |
| 8   | 13E31A0110 | CHENNADI KAVYASREE         | IV   | 16    | PASS      |
| 9   | 13E31A0111 | CHITYALA KARNAKAR          | IV   | 16    | PASS      |
| 10  | 13E31A0112 | CHUKKA RANJITHKUMAR        | IV   | 16    | PASS      |
| 11  | 13E31A0113 | DABBA ROHITH               | IV   | 16    | PASS      |
| 12  | 13E31A0114 | DIVITI DEEKSHA             | IV   | 16    | PASS      |
| 13  | 13E31A0115 | G. MAHESH KUMAR            | IV   | 16    | PASS      |
| 14  | 13E31A0116 | GOLI SANDEEP SHAHIL        | IV   | 16    | PASS      |
| 15  | 13E31A0117 | GOPIREDDY SOMASHEKAR REDDY | IV   | 16    | PASS      |
| 16  | 13E31A0118 | GURRAM RAGHAVENDHAR        | IV   | 16    | PASS      |
| 17  | 13E31A0119 | IRFAN AHMED KHAN           | IV   | 16    | PASS      |
| 18  | 13E31A0120 | MD FAIYAZ                  | IV   | 16    | PASS      |
| 19  | 13E31A0121 | KARUMANCHI VAMSI KRISHNA   | IV   | 15    | PASS      |
| 20  | 13E31A0122 | KASTURI RAKESH             | IV   | 16    | PASS      |
| 21  | 13E31A0123 | KONDABATHULA RAJESH        | IV   | 16    | PASS      |
| 22  | 13E31A0124 | KOUSALYA                   | IV   | 15    | PASS      |
| 23  | 13E31A0125 | MADHAVI KISHORE KUMAR      | IV   | 16    | PASS      |
| 24  | 13E31A0126 | MADDOORI VIJAY             | IV   | 14    | PASS      |
| 25  | 13E31A0127 | MD MASROOR ALAM            | IV   | 15    | PASS      |
| 26  | 13E31A0128 | MEDIPELLY VINOD REDDY      | IV   | 15    | PASS      |
| 27  | 13E31A0129 | MEGHAVATH RENUKA           | IV   | 16    | PASS      |
| 28  | 13E31A0130 | MENDE SUSHANTH ENOCH       | IV   | 14    | PASS      |
| 29  | 13E31A0131 | MENGA NAVEEN KUMAR         | IV   | 16    | PASS      |
| 30  | 13E31A0132 | MIRZA MOHAMMED ALI BAIG    | IV   | 15    | PASS      |
| 31  | 13E31A0133 | MOHAMMED ILYASUDDIN        | IV   | 14    | PASS      |
| 32  | 13E31A0134 | MOHAMMED MOUAZZAM          | IV   | 18    | PASS      |
| 33  | 13E31A0135 | MOHD ANAS RATEEQ           | IV   | 15    | PASS      |
| 34  | 13E31A0136 | MOHD SHARIF AHMED          | IV   | 16    | PASS      |
| 35  | 13E31A0137 | MUNGELA VISHWATEJA         | IV   | 15    | PASS      |
| 36  | 13E31A0138 | MUSKU SANTOSH              | IV   | 16    | PASS      |



*K. Srinivas*  
PRINCIPAL  
MAHAVEER  
INSTITUTE OF SCIENCE & TECHNOLOGY  
Bandlaguda, Hyd-500 006.

|    |            |                         |    |    |      |
|----|------------|-------------------------|----|----|------|
| 37 | 13E31A0139 | NALUVALA NAGESH KUMAR   | IV | 16 | PASS |
| 38 | 13E31A0140 | PERIKA KRISHNA          | IV | 15 | PASS |
| 39 | 13E31A0141 | PRAKASH PALLE           | IV | 16 | PASS |
| 40 | 13E31A0142 | R.VINOD KUMAR           | IV | 16 | PASS |
| 41 | 13E31A0143 | S K SHANAWAZ            | IV | 15 | PASS |
| 42 | 13E31A0144 | S SHIVA KUMAR           | IV | 16 | PASS |
| 43 | 13E31A0145 | SHANEGALA KAPIL KUMAR   | IV | 14 | PASS |
| 44 | 13E31A0146 | SHIV SHANKER SINGH      | IV | 15 | PASS |
| 45 | 13E31A0147 | SHIVARATRI DIVYA        | IV | 15 | PASS |
| 46 | 13E31A0148 | SYED AHAMED MAHBOOB ALI | IV | 16 | PASS |
| 47 | 13E31A0150 | ULLI SAI KIRAN          | IV | 14 | PASS |
| 48 | 13E31A0151 | VEERABOINA SRINIVAS     | IV | 16 | PASS |
| 49 | 13E31A0152 | VEESAM SUSMITHA         | IV | 15 | PASS |
| 50 | 14E35A0101 | BIRADHAR ESHWAR RAO     | IV | 14 | PASS |
| 51 | 14E35A0102 | AKULA MAHESH            | IV | 16 | PASS |
| 52 | 14E35A0103 | MD. IMTHIAZ HUSSAIN     | IV | 16 | PASS |
| 53 | 14E35A0104 | NUNAVATHI MOTHILAL      | IV | 12 | PASS |
| 54 | 14E35A0105 | BANDHARABOINA RAMESH    | IV | 12 | PASS |



*Kshiraj*

PRINCIPAL  
VEER  
DEPARTMENT OF SCIENCE & TECHNOLOGY  
HYDRABAD, HYD-500 005.



**MAHAVER INSTITUTE OF SCIENCE & TECHNOLOGY, HYDERABAD**  
**CIVIL ENGINEERING STUDENTS ATTENDANCE**

**B.TECH IV YEAR II SEM 2016-2017 BATCH II (Date - 14/03/2016 - 24/03/2016)**

| S.No | Hall Ticket No | Name of the Candidate     | 1 | 2 | 3 | 4 | 5 | 6 | 7 | 8 | 9 | 10 |
|------|----------------|---------------------------|---|---|---|---|---|---|---|---|---|----|
| 1    | 13E31A0101     | A.AKASH GOUD              | P | A | P | P | P | P | P | P | P | P  |
| 2    | 13E31A0103     | AKKINAPPELLY ARAVIND      | P | P | A | P | P | P | P | P | P | P  |
| 3    | 13E31A0104     | ALE SANATH KUMAR          | P | P | P | A | P | P | P | P | P | P  |
| 4    | 13E31A0106     | ANDRALA VIJAYA            | P | P | A | P | P | P | P | P | P | P  |
| 5    | 13E31A0107     | B SRIVANI                 | P | P | P | A | P | P | P | P | P | P  |
| 6    | 13E31A0108     | BATTHULA VINAY            | P | P | A | P | A | A | P | P | P | A  |
| 7    | 13E31A0109     | BEKKAM SHARAN KUMAR       | P | P | A | P | P | P | P | P | A | P  |
| 8    | 13E31A0110     | CHENNADI NAVYASREE        | P | A | P | A | P | P | P | P | P | P  |
| 9    | 13E31A0111     | CHITYALA KARNAKAR         | P | P | A | P | P | P | A | P | P | P  |
| 10   | 13E31A0112     | CHUKKA RANJITHKUMAR       | P | P | P | P | P | P | P | A | P | P  |
| 11   | 13E31A0113     | DABBA ROHITHI             | P | P | P | A | P | P | P | P | A | A  |
| 12   | 13E31A0114     | DIVITI DEEKSHA            | P | P | P | A | P | P | A | P | P | P  |
| 13   | 13E31A0115     | G. MAHESH KUMAR           | P | A | P | P | P | P | P | P | P | P  |
| 14   | 13E31A0116     | GOLI SANDEEP SHAHIL       | A | P | P | P | A | P | P | P | P | P  |
| 15   | 13E31A0117     | GOIREDDY SOMASHEKAR REDDY | P | P | P | P | P | A | P | P | P | P  |
| 16   | 13E31A0118     | GURRAM RAGHAVENDHAR       | P | P | P | P | P | P | A | P | P | P  |
| 17   | 13E31A0119     | IRFAN AHMED KIYAN         | A | P | P | P | P | P | P | P | P | A  |



*Kantiy*

**PRINCIPAL**  
**MAHAVER**  
**INSTITUTE OF SCIENCE & TECHNOLOGY**  
 Hyderabad, 500 005





|    |            |                         |   |   |   |   |   |   |   |   |   |   |   |   |
|----|------------|-------------------------|---|---|---|---|---|---|---|---|---|---|---|---|
| 38 | 13E31A0140 | PERINA KRISHNA          | P | P | P | P | P | A | P | P | P | P | P | P |
| 39 | 13E31A0141 | PRAKASH PALLE           | P | A | P | P | P | P | P | P | P | P | P | P |
| 40 | 13E31A0142 | R.VINOD KUMAR           | P | P | P | P | P | P | P | A | P | P | P | P |
| 41 | 13E31A0143 | S.K.SHANAWAZ            | P | P | P | P | P | P | P | P | P | P | P | A |
| 42 | 13E31A0144 | S.SHIVA KUMAR           | A | P | P | P | P | P | P | P | P | P | P | P |
| 43 | 13E31A0145 | SHANEGALA KAPIL KUMAR   | P | P | A | P | P | P | P | P | P | P | P | P |
| 44 | 13E31A0146 | SHIV SHANKER SINGH      | P | P | P | P | P | P | A | P | P | P | P | P |
| 45 | 13E31A0147 | SHIVARATRI DIVYA        | P | P | P | P | P | P | P | P | A | P | P | P |
| 46 | 13E31A0148 | SYED AHAMED MAHBOOB ALI | P | P | P | A | P | P | P | P | P | P | P | P |
| 47 | 13E31A0150 | ULLI SAI KIRAN          | P | P | A | P | P | P | P | P | P | P | P | P |
| 48 | 13E31A0151 | VEERABOINA SRINIVAS     | P | P | P | A | P | P | P | P | P | P | P | P |
| 49 | 13E31A0152 | VEESAM SUSMITHA         | P | P | P | P | A | P | P | P | P | P | P | P |
| 50 | 14E35A0101 | BIRADHAR ESHWAR RAO     | P | P | P | A | P | P | P | P | P | P | P | P |
| 51 | 14E35A0102 | AKULA MAHESH            | P | P | P | P | P | P | A | P | P | P | P | P |
| 52 | 14E35A0103 | MD. IMTHIYAZ HUSSAIN    | P | P | P | P | P | P | P | P | P | A | P | P |
| 53 | 14E35A0104 | NUNAVATH MOTHILAL       | A | P | P | P | P | P | P | P | P | P | P | P |
| 54 | 14E35A0105 | BANDHARABOINA RAMESH    | P | P | P | P | P | A | P | P | P | P | P | P |



*Handwritten signature*

PRINCIPAL  
**M.S. RAVEER**  
 INSTITUTE OF SCIENCE & TECHNOLOGY  
 Bandikpuda, Hydrabad-500 005.





Technical Training Exam on STAAD Pro V8 Software  
(A.Y-2016-17)

2x10=20 Marks

Answer All the Questions

- a. Analyse the given beam using Staad Pro Cross section of Beam 200mmx400mm Grade of Concrete M 25 Grade of Steel Fe 415. Plot SFD, BMD and deflected profile.

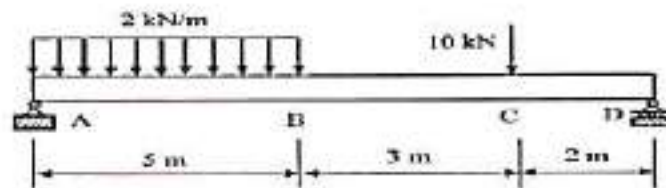

- b. Analyse the given beam using Staad Pro Cross section of Beam 200mmx400mm Grade of Concrete M 30 Grade of Steel Fe 415. Plot SFD, BMD and deflected profile.

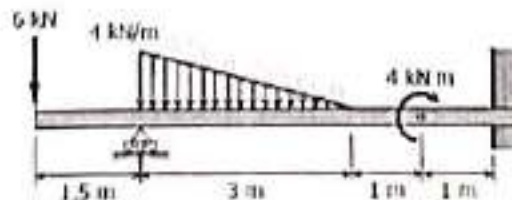

*K. Mahaveer*  
PRINCIPAL  
MAHAVEER  
INSTITUTE OF SCIENCE & TECHNOLOGY  
Bandlaguda, Hyd 500 005.



- c. Analyse the given beam using Staad Pro Cross section of Beam 200mmx400mm Grade of Concrete M 25 Grade of Steel Fe 415. Plot SFD,BMD and deflected profile.

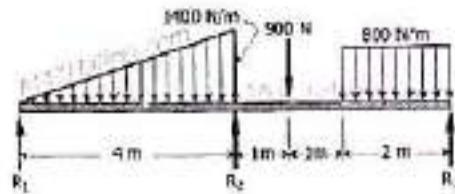

*Kshiraj*  
PRINCIPAL  
MAHAVEER  
INSTITUTE OF SCIENCE & TECHNOLOGY  
Bardhaman, West Bengal 713 100, INDIA.

Vysapuri, Bandlaguda Post:Keshavgi, Hyderabad-500 005, Telangana INDIA  
Tel: 040-64596979,20020773, Fax: 040-24451003  
E-mail: [principal.mahaveer@gmail.com](mailto:principal.mahaveer@gmail.com)  
Website: [www.mist.ac.in](http://www.mist.ac.in),

**MAHAVEER**

INSTITUTE OF SCIENCE & TECHNOLOGY

Approved by AICTE, Affiliated to JNTUH,Hyd.



## STAAD PROv18 COURSE

### Summery

### Department of Civil Engineering

- Model Generation and Editing
- Assigning loads
- Creating Load Combinations
- Concrete Design
- Seismology
- Steel Design
- Foundation Designs
- Report Generation and Plotting



*K. Srinivas*  
PRINCIPAL  
MAHAVEER  
INSTITUTE OF SCIENCE & TECHNOLOGY  
Bandlaguda, Hyd-500 005.

Vysapuri, Bandlaguda Post:Keshavgiri,  
Hyderabad-500 005, Telangana INDIA  
Tel: 040-64596979,20020773, Fax: 040-24455003  
E-mail: [principal.mahaveer@gmail.com](mailto:principal.mahaveer@gmail.com),  
Website: [www.mist.ac.in](http://www.mist.ac.in),

**MAHAVEER**  
INSTITUTE OF SCIENCE & TECHNOLOGY  
Approved by AICTE, Affiliated to JNTUH,Hyd.



## CERTIFICATE OF COURSE COMPLETION

This certificate is presented to \_\_\_\_\_ of  
MIST,who has successfully completed technical training course  
on "STAAD ProVi8" held from \_\_\_\_\_ to \_\_\_\_\_  
and found the student performance to be excellent.



CH. SWETHAMBER

HOD

Civil department



*Handwritten signature*

PRINCIPAL  
MAHAVEER  
INSTITUTE OF SCIENCE & TECHNOLOGY  
Bandlaguda, Hyderabad



Vysapuri, Bandlaguda Post:Keshavpuri,

# MAHAVEER

INSTITUTE OF SCIENCE & TECHNOLOGY

Hyderabad-500 005, TELANGANA INDIA

Tel: 040-64596979,8978380692.Fax: 040-24455003

E-mail: [g3hod.eee@gmail.com](mailto:g3hod.eee@gmail.com)

Website: [www.mist.ac.in](http://www.mist.ac.in)

Approved by AICTE, Affiliated to JNTUH,Hyd.



## DEPARTMENT OF ELECTRICAL & ELECTRONICS

Date: 1-02-2017

To  
The Principal,  
Mist,  
Hyderabad.

Sub:Proposal for Add on course-Reg.

Respected sir,

We are going to conduct two weeks workshop on **IMPORTANCY OF EARTHING**. We require your approval to go head for further proceeding and hope to get an opportunity to serve you the best.

With thanks and regards

*R.V.Amraeth*  
HOD-EEE

Professor & Head

Dept. of Electrical & Electronics E.  
Mahaveer Institute of Science & Technol  
Vysapuri, Bandlaguda, Keshavpuri,  
Hyderabad - 500 005.

*Kshudh*  
INSTITUTE OF SCIENCE & TECHNOLOGY  
Bandlaguda, Hyd-500 005.

Vysapuri, Bandlaguda Post:Keshavgiri,

# MAHAVEER



Hyderabad-500 005, TELANGANA INDIA

Tel: 040-64596979,8978380692,Fax: 040-244558003

E-mail: [e3hod.eee@gmail.com](mailto:e3hod.eee@gmail.com),

Website: [www.mist.ac.in](http://www.mist.ac.in),

Approved by AICTE, Affiliated to JNTUH,Hyd.

## DEPARTMENT OF ELECTRICAL & ELECTRONICS

Date: 01-02-2017

### CIRCULAR

Technical Trainings for III B. Tech students are starting from 07-02-2017 onwards. All HODs and placements coordinators have to manage the trainings and ensure 95% attendance all through the sessions.

All mentors need to send the compiled feedback report to HOD at [e3hod.eee@gmail.com](mailto:e3hod.eee@gmail.com) daily. Mentors are advised to take care of PNR (Students not participating in training).

Agenda: **Importancy of Earthing**

Design & Development of Curriculum for Add on Courses Faculty names I.Dr RV AMARNATH

2.G .Prem kumar roddy

  
R.V. AMARNATH  
MAHAVEER  
INSTITUTE OF SCIENCE & TECHNOLOGY  
Bandlaguda, Hyd-500 005,

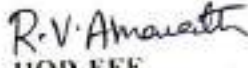
  
R.V. Amarnath  
HOD-EEE  
Professor & Head  
Dept. of Electrical & Electronics En.  
Mahaveer Institute of Science & Techno  
Vyasapuri, Bandlaguda, Keshavgiri,  
Hyderabad - 500 005.

Vysapuri, Bandlaguda Post:Keshavgirl,

# MAHAVEER



Hyderabad-500 005, TELANGANA INDIA

Tel: 040-64596979,8978380692,Fax: 040-24455003

E-mail: e3hod.eee@gmail.com.

Website: www.mist.ac.in.

Approved by AICTE, Affiliated to JNTUH,Hyd.

## DEPARTMENT OF ELECTRICAL & ELECTRONICS

### SYLLABUS FOR Importance of Earthing

| SNO | TOPIC COVERED  | DURATION |
|-----|--|----------|
| 1   | Introduction   | 3        |
| 2   | Classification of resistance                         | 3        |
| 3   | Types of earthing system                             | 3        |
| 4   | Plate earthing                                       | 3        |
| 5   | Pipe earthing  | 3        |
| 6   | Sizes of the conductor                               | 3        |
| 7   | Running earthing                                     | 3        |
| 8   | Importance of earthing                               | 3        |
| 9   | Testing for fault                                    | 3        |
| 10  | measuring insulation resistance by insulation tester | 3        |

*R.V.Amaranth*  
HOD-EEE

*Kshirg*  
PRINCIPAL  
MAHAVEER  
INSTITUTE OF SCIENCE & TECHNOLOGY  
Bandlaguda, Hyd-500 005.

Professor & Head  
Dept. of Electrical & Electronics Engg  
Mahaveer Institute of Science & Technology  
Vysapuri, Bandlaguda, Keshavgirl,  
Hyderabad - 500 005.



Vysapuri, Bandlaguda Post:Keshavgiri,

# MAHAVEER



Hyderabad-500 005, TELANGANA INDIA

Tel: 040-64596979,8978380692, Fax: 040-24455003

E-mail: e3hod.eee@gmail.com,

Website: www.mist.ac.in,

Approved by AICTE, Affiliated to JNTUH,Hyd.

## DEPARTMENT OF ELECTRICAL & ELECTRONICS

### LIST OF REGISTERED STUDENTS FOR Importance of Earthing

| SNO | HALL TICKET NO | NAME OF THE STUDENT       |
|-----|----------------|---------------------------|
| 1   | 14E31A0201     | ANANTHARAM SANDEEP KUMAR  |
| 2   | 14E31A0202     | ANYARAMBATLA ANUSHA       |
| 3   | 14E31A0203     | AREKATLA POOJITHA REDDY   |
| 4   | 14E31A0204     | BANDI BHEESHMA REDDY      |
| 5   | 14E31A0205     | BHUPATHI HARIKA           |
| 6   | 14E31A0210     | ENTI VINAY KUMAR REDDY    |
| 7   | 14E31A0211     | K SHRAVAN KUMAR           |
| 8   | 14E31A0213     | LOSIRLU SURESH KUMAR      |
| 9   | 14E31A0214     | MACCHA SANDEEP            |
| 10  | 14E31A0215     | MALLOJU MADHU             |
| 11  | 14E31A0216     | MIR ABDUL KAREEM KHAN     |
| 12  | 14E31A0217     | MOHAMMED ABDUL VAKEEL     |
| 13  | 14E31A0218     | MOHAMMED ABRAR            |
| 14  | 14E31A0219     | MOHAMMED YAKUB PASHA      |
| 15  | 14E31A0220     | PUVVADA SHAILENDRA        |
| 16  | 14E31A0221     | RISHAV VERMA              |
| 17  | 14E31A0222     | S POOJA                   |
| 18  | 14E31A0223     | SAPAVATH ANITHA           |
| 19  | 14E31A0224     | SUMANABOINA RAGHU         |
| 20  | 14E31A0225     | SRIRAM BALA GOUD          |
| 21  | 14E31A0226     | SUTHARI MANOJ KUMAR       |
| 22  | 14E31A0227     | TALLURI GREESHMA CHOWDARY |
| 23  | 14E31A0228     | VARUKOLU SHEKHAR          |
| 24  | 15E35A0201     | AGUMAMIDI SAIRAM          |
| 25  | 15E35A0202     | BASAKONDA BHOOMESH        |
| 26  | 15E35A0204     | DYAVANAPELLI RAJKUMAR     |

*Keshav*  
Principal  
MAHAVEER  
INSTITUTE OF SCIENCE & TECHNOLOGY  
Bandlaguda, Hyd-500 005.

Vysapuri, Bandlaguda Post:Keshavgi.

# MAHAVEER



Hyderabad-500 005, TELANGANA INDIA

Tel: 040-64596979,8978380692,Fax: 040-24455003

E-mail: e3hod.eee@gmail.com

Website: www.mist.ac.in

Approved by AICTE, Affiliated to JNTU(H)Hyd.

## DEPARTMENT OF ELECTRICAL & ELECTRONICS

|    |            |                  |
|----|------------|------------------|
| 27 | 15E35A0205 | GUNDAGANI MAHESH |
| 28 | 15E35A0206 | JAKKAWAR VIDAY   |
| 29 | 15E35A0207 | KATTA SAIKRISHNA |
| 30 | 15E35A0208 | TANVEER KHAN     |
| 31 | 15E35A0209 | TEKKAM HARISH    |
| 32 | 13E31A0215 | GADDAM RAKESH    |

### Importancy of Earthing QUESTION PAPER

Duration: 120 Minutes

4 X 5 = 20 Marks

Answer the following all questions. Each question carries 5 mark.

1. What are maximum permissible values of resistance of Earth system?
2. Explain minimum size of the earth continuity conductor?
3. Explain about earthing system?
4. Explain earth resistance exceed the permissible values of resistance of Earth system?

*K. Srinivas*  
PRINCIPAL  
**MAHAVEER**  
INSTITUTE OF SCIENCE & TECHNOLOGY  
Bandlaguda, Hyd-500 005.

*R.V. Amarant*  
HOD-EEE  
Professor & Head  
Dept. of Electrical & Electronics Engg  
Mahaveer Institute of Science & Technology  
Vysapuri, Bandlaguda, Keshavgi,  
Hyderabad - 500 005.

Vysapuri, Bandlaguda Post:Keshavgi,

# MAHAVEER



Hyderabad-500 005, TELANGANA INDIA

Tel: 040-64596979,8978380692,Fax: 040-24455903

E-mail: e3hod.eee@gmail.com,

Website: www.mist.ac.in,

Approved by AICTE, Affiliated to JNTUH,Hyd.

## DEPARTMENT OF ELECTRICAL & ELECTRONICS

### RESULT SHEET FOR Importance of Earthing REGISTERED STUDENTS

| SNO | HALL TICKET NO | NAME OF THE STUDENT          | MARKS (20) | RESULT |
|-----|----------------|------------------------------|------------|--------|
| 1   | 14E31A0201     | ANANTHARAM SANDEEP<br>KUMAR  | 20         | PASS   |
| 2   | 14E31A0202     | ANYARAMBATLA ANUSHA          | 19         | PASS   |
| 3   | 14E31A0203     | AREKATLA POOJITHA<br>REDDY   | 20         | PASS   |
| 4   | 14E31A0204     | BANDI BHEESHMA REDDY         | 18         | PASS   |
| 5   | 14E31A0205     | BHUPATHI HARIKA              | 20         | PASS   |
| 6   | 14E31A0210     | ENTI VINAY KUMAR REDDY       | 20         | PASS   |
| 7   | 14E31A0211     | K SHRAVAN KUMAR              | 19         | PASS   |
| 8   | 14E31A0213     | LOSIRLU SURESH KUMAR         | 20         | PASS   |
| 9   | 14E31A0214     | MACCHA SANDEEP               | 18         | PASS   |
| 10  | 14E31A0215     | MALLOJU MADHU                | 20         | PASS   |
| 11  | 14E31A0216     | MIR ABDUL KAREEM KHAN        | 20         | PASS   |
| 12  | 14E31A0217     | MOHAMMED ABDUL<br>VAKEEL     | 16         | PASS   |
| 13  | 14E31A0218     | MOHAMMED ABRAR               | 20         | PASS   |
| 14  | 14E31A0219     | MOHAMMED YAKUB PASHA         | 20         | PASS   |
| 15  | 14E31A0220     | PUVVADA SHAIENDRA            | 17         | PASS   |
| 16  | 14E31A0221     | RISHAV VERMA                 | 20         | PASS   |
| 17  | 14E31A0222     | S POOJA                      | 20         | PASS   |
| 18  | 14E31A0223     | SAPAVATH ANITHA              | 16         | PASS   |
| 19  | 14E31A0224     | SOMANABOINA RAGHU            | 20         | PASS   |
| 20  | 14E31A0225     | SRIRAM BALA GOUD             | 20         | PASS   |
| 21  | 14E31A0226     | SUTHARI MANOJ KUMAR          | 18         | PASS   |
| 22  | 14E31A0227     | TALLURI GREESHMA<br>CHOWDARY | 20         | PASS   |
| 23  | 14E31A0228     | VARUKOLU SHEKHAR             | 19         | PASS   |
| 24  | 15E35A0201     | AGUMAMIDI SAIRAM             | 20         | PASS   |
| 25  | 15E35A0202     | BASAKONDA BHOOMESH           | 18         | PASS   |



Vysapuri, Bandlaguda Post:Keshavgi,

# MAHAVEER



Hyderabad-500 005, TELANGANA INDIA

Tel: 040-64596979,8978380692, Fax: 040-24455003

E-mail: e3hod.eee@gmail.com,

Website: www.mist.ac.in,

Approved by AICTE, Affiliated to JNTUH,Hyd.

## DEPARTMENT OF ELECTRICAL & ELECTRONICS

|    |            |                       |    |      |
|----|------------|-----------------------|----|------|
| 26 | 15E35A0204 | DYAVANAPELLI RAJKUMAR | 20 | PASS |
| 27 | 15E35A0205 | GUNDAGANI MAHESH      | 20 | PASS |
| 28 | 15E35A0206 | JAKKAWAR VIJAY        | 18 | PASS |
| 29 | 15E35A0207 | KATTA SAIKRISHNA      | 20 | PASS |
| 30 | 15E35A0208 | TANVEER KHAN          | 19 | PASS |
| 31 | 15E35A0209 | TEKKAM HARISH         | 20 | PASS |
| 32 | 13E31A0215 | GADDAM RAKESH         | 18 | PASS |

No. of students Registered:32

No. of students Passed:32

No. of students failed:NIL

*R.V. Anant*

Professor & Head

Dept. of Electrical & Electronics E.  
Mahaveer Institute of Science & Tech  
Vysapuri, Bandlaguda, Keshavgi,  
Hyderabad - 500 005.

*K. S. S. S.*

PRINCIPAL  
MAHAVEER  
INSTITUTE OF SCIENCE & TECHNOLOGY  
Bandlaguda, Hyd-500 005.

Vysapuri, Bandlaguda Post:Keshavgiri,

# MAHAVEER



Hyderabad-500 005, TELANGANA INDIA

Tel: 040-64596979,8978380692, Fax: 040-24455903

E-mail: [e3hod.eee@gmail.com](mailto:e3hod.eee@gmail.com),

Website: [www.mist.ac.in](http://www.mist.ac.in),

Approved by AICTE, Affiliated to JNTUH,Hyd.

## DEPARTMENT OF ELECTRICAL & ELECTRONICS

---

### SUMMARY REPORT OF Importancy of Earthing

Earthing is used to protect you from an electric shock. It does this by providing a path (a protective conductor) for a fault current to flow to earth. It also causes the protective device (either a circuit-breaker or fuse) to switch off the electric current to the circuit that has the fault.

  
COORDINATOR

Copy to:

1. Department Notice Board
2. Principal for Information
3. Committee Members (Academic)



PRINCIPAL  
MAHAVEER  
INSTITUTE OF SCIENCE & TECHNOLOGY  
Bandlaguda, Hyd-500 005.

**A Two week Certificate Course**  
On  
**"Importancy of Earthing"**  
(7<sup>th</sup> - 25<sup>th</sup> feb 2017)

**REGISTRATION FORM**

Full Name: .....

Designation: .....

Organization: .....

Experience (in years): .....

Industry:..... Teaching:.....

Research:.....

Correspondence  
Address:.....  
.....  
.....

E- mail id for communication (must):  
.....  
.....

Ph: .....

Sign of Applicant: .....

Signature of  
Head of the Institution with official Seal

**Important Dates**

Last date of Receiving Applications: 05.2.2017  
Intimation to the selected participants: 6.2.2017

**General Information:**

- > Tea, snacks and lunch will be served.
- > Certificates will be issued to all the participants.
- > Transportation will be provided from city to college.
- > Limited accommodation will be provided on request from participants.

**About the College:**

An Institute committed to quality education MIST aims at providing learning with a technology edge. Right from its inception in 2011, it has turning itself to meet this objective. It endeavors to provide consistent training to the students to help them evolve as competent professionals in the highly competitive world.

**About the Department:**

The Department of E.E.E is working with a mission to contribute through excellence in technical education, with research orientation. It imparts ethical & moral values to the student's so as to make them emerge as responsible professionals. With its experienced faculty members having excellent academic backgrounds, it trains students supplementing classroom lectures with computer aided demonstrations making their learning a rich and rewarding experience

Resource person: Dr. M.Rajendar Reddy

**Contact Details:**

Co-ordinators  
Dr.R.V.Amarnath

Head EEE Dept, MIST

Co-convenor  
Mr.G. Prem Kumar Reddy,

Assoc.Prof., EEE Dept, MIST

College Numbers: Tel: 04065810046, 8979380692,  
Email: e3hod.eee@gmail.com,

**A Two week Certificate Course**  
On  
**"Importancy of Earthing"**  
(7<sup>th</sup> - 25<sup>th</sup> feb 2017)



*Organizing Secretary*

*Chief Patron*

Sri. S.Sudershan Reddy, Chairman, MIST

Sri. S. Surendar Reddy, Secretary, MIST

Sri S. Dharmajay Reddy, Joint Secretary, MIST

*Patron*

Dr.KSSSN Reddy, Principal, MIST

*Organized by*



**Department of Electrical & Electronics  
Engineering**

**Mahaveer Institute of Science & Technology**  
Nyasapuri, Bandlaguda, Hyderabad 500005.  
(Affiliated to JNTUH)



Page: 24 of 25

| Attendance of Teaching |             | Date: 24/08/2024       |   |   |   |   |   |   |   |   |   |    |    |    |    |    |    |    |    |    |    |    |    |    |    |    |    |    |    |    |    |    |
|------------------------|-------------|------------------------|---|---|---|---|---|---|---|---|---|----|----|----|----|----|----|----|----|----|----|----|----|----|----|----|----|----|----|----|----|----|
| SNO                    | HALL TICKET | NAME OF THE STUDENT    | 1 | 2 | 3 | 4 | 5 | 6 | 7 | 8 | 9 | 10 | 11 | 12 | 13 | 14 | 15 | 16 | 17 | 18 | 19 | 20 | 21 | 22 | 23 | 24 | 25 | 26 | 27 | 28 | 29 | 30 |
| 1                      | 14E31A0201  | ANANTHARAM SANDEEP K   | P | P | P | P | P | P | P | P | P | P  | P  | P  | P  | P  | P  | P  | P  | P  | P  | P  | P  | P  | P  | P  | P  | P  | P  | P  | P  | P  |
| 2                      | 14E31A0202  | ANYARAMBATLA ANUSHA    | P | P | P | P | P | P | P | P | P | P  | P  | P  | P  | P  | P  | P  | P  | P  | P  | P  | P  | P  | P  | P  | P  | P  | P  | P  | P  | P  |
| 3                      | 14E31A0203  | AREKATLA POOJITHA REDD | P | P | P | P | P | P | P | P | P | P  | P  | P  | P  | P  | P  | P  | P  | P  | P  | P  | P  | P  | P  | P  | P  | P  | P  | P  | P  | P  |
| 4                      | 14E31A0204  | BANDI BHEESHMA REDDY   | P | P | P | P | P | P | P | P | P | P  | P  | P  | P  | P  | P  | P  | P  | P  | P  | P  | P  | P  | P  | P  | P  | P  | P  | P  | P  | P  |
| 5                      | 14E31A0205  | BHUPATHI HARIKA        | P | P | P | P | P | P | P | P | P | P  | P  | P  | P  | P  | P  | P  | P  | P  | P  | P  | P  | P  | P  | P  | P  | P  | P  | P  | P  | P  |
| 6                      | 14E31A0210  | ENTI VINAY KUMAR REDDY | P | P | P | P | P | P | P | P | P | P  | P  | P  | P  | P  | P  | P  | P  | P  | P  | P  | P  | P  | P  | P  | P  | P  | P  | P  | P  | P  |
| 7                      | 14E31A0211  | K SHRAVAN KUMAR        | P | P | P | P | P | P | P | P | P | P  | P  | P  | P  | P  | P  | P  | P  | P  | P  | P  | P  | P  | P  | P  | P  | P  | P  | P  | P  | P  |
| 8                      | 14E31A0213  | LOSIRLU SURESH KUMAR   | P | P | P | P | P | P | P | P | P | P  | P  | P  | P  | P  | P  | P  | P  | P  | P  | P  | P  | P  | P  | P  | P  | P  | P  | P  | P  | P  |
| 9                      | 14E31A0214  | MACCHA SANDEEP         | P | P | P | P | P | P | P | P | P | P  | P  | P  | P  | P  | P  | P  | P  | P  | P  | P  | P  | P  | P  | P  | P  | P  | P  | P  | P  | P  |
| 10                     | 14E31A0215  | MALLOJU MADHU          | P | P | P | P | P | P | P | P | P | P  | P  | P  | P  | P  | P  | P  | P  | P  | P  | P  | P  | P  | P  | P  | P  | P  | P  | P  | P  | P  |
| 11                     | 14E31A0216  | MIR ABDUL KAREEM KHAN  | P | P | P | P | P | P | P | P | P | P  | P  | P  | P  | P  | P  | P  | P  | P  | P  | P  | P  | P  | P  | P  | P  | P  | P  | P  | P  | P  |
| 12                     | 14E31A0217  | MOHAMMED ABDUL VAKIEF  | P | P | P | P | P | P | P | P | P | P  | P  | P  | P  | P  | P  | P  | P  | P  | P  | P  | P  | P  | P  | P  | P  | P  | P  | P  | P  | P  |
| 13                     | 14E31A0218  | MOHAMMED ABRAR         | P | P | P | P | P | P | P | P | P | P  | P  | P  | P  | P  | P  | P  | P  | P  | P  | P  | P  | P  | P  | P  | P  | P  | P  | P  | P  | P  |
| 14                     | 14E31A0219  | MOHAMMED YAKUB PASHA   | P | P | P | P | P | P | P | P | P | P  | P  | P  | P  | P  | P  | P  | P  | P  | P  | P  | P  | P  | P  | P  | P  | P  | P  | P  | P  | P  |
| 15                     | 14E31A0220  | PUVVADA SHALENDRA      | P | P | P | P | P | P | P | P | P | P  | P  | P  | P  | P  | P  | P  | P  | P  | P  | P  | P  | P  | P  | P  | P  | P  | P  | P  | P  | P  |
| 16                     | 14E31A0221  | RISHAV VERMA           | P | P | P | P | P | P | P | P | P | P  | P  | P  | P  | P  | P  | P  | P  | P  | P  | P  | P  | P  | P  | P  | P  | P  | P  | P  | P  | P  |
| 17                     | 14E31A0222  | S POOJA                | P | P | P | P | P | P | P | P | P | P  | P  | P  | P  | P  | P  | P  | P  | P  | P  | P  | P  | P  | P  | P  | P  | P  | P  | P  | P  | P  |
| 18                     | 14E31A0223  | SAPAVATH ANITHA        | P | P | P | P | P | P | P | P | P | P  | P  | P  | P  | P  | P  | P  | P  | P  | P  | P  | P  | P  | P  | P  | P  | P  | P  | P  | P  | P  |

|    |            |                          |   |   |   |   |   |   |   |   |   |   |   |   |   |   |   |   |   |   |   |   |   |   |   |   |   |   |   |   |   |   |
|----|------------|--------------------------|---|---|---|---|---|---|---|---|---|---|---|---|---|---|---|---|---|---|---|---|---|---|---|---|---|---|---|---|---|---|
| 19 | 14E31A0224 | SOMANABOINA RAGHU        | P | P | P | P | P | P | P | P | P | P | P | P | P | P | P | P | P | P | P | P | P | P | P | P | P | P | P | P | P | P |
| 20 | 14E31A0225 | SRIRAM BALA GOUD         | P | P | P | P | P | P | P | P | P | P | P | P | P | P | P | P | P | P | P | P | P | P | P | P | P | P | P | P | P | P |
| 21 | 14E31A0226 | SUTHARI MANOJ KUMAR      | P | P | P | P | P | P | P | P | P | P | P | P | P | P | P | P | P | P | P | P | P | P | P | P | P | P | P | P | P | P |
| 22 | 14E31A0227 | TALLURI GRESHMA CHOWIT   | P | P | P | P | P | P | P | P | P | P | P | P | P | P | P | P | P | P | P | P | P | P | P | P | P | P | P | P | P | P |
| 23 | 14E31A0228 | VARUKOLU SHEKHAR         | P | P | P | P | P | P | P | P | P | P | P | P | P | P | P | P | P | P | P | P | P | P | P | P | P | P | P | P | P | P |
| 24 | 15E35A0201 | AGUNAMIDI SAIRAM         | P | P | P | P | P | P | P | P | P | P | P | P | P | P | P | P | P | P | P | P | P | P | P | P | P | P | P | P | P | P |
| 25 | 15E35A0202 | BASAKONDA BHOOMESH       | A | A | P | P | P | A | P | P | P | P | P | P | P | P | P | P | P | P | P | P | P | P | P | P | P | P | P | P | P | P |
| 26 | 15E35A0204 | DYAVANAPPELLI RAIKUMAR   | P | P | P | P | P | P | P | P | P | P | P | P | P | P | P | P | P | P | P | P | P | P | P | P | P | P | P | P | P | P |
| 27 | 15E35A0205 | GUNDAGANI MAHESH         | P | P | P | P | P | P | P | P | P | P | P | P | P | P | P | P | P | P | P | P | P | P | P | P | P | P | P | P | P | P |
| 28 | 15E35A0206 | JAKKAWAR VIJAY           | P | P | P | P | P | P | P | P | P | P | P | P | P | P | P | P | P | P | P | P | P | P | P | P | P | P | P | P | P | P |
| 29 | 15E35A0207 | KATTA SAIKRISHNA         | P | P | P | P | P | P | P | P | P | P | P | P | P | P | P | P | P | P | P | P | P | P | P | P | P | P | P | P | P | P |
| 30 | 15E35A0208 | TANVEER KHAN             | P | P | P | P | P | P | P | P | P | P | P | P | P | P | P | P | P | P | P | P | P | P | P | P | P | P | P | P | P | P |
| 31 | 15E35A0209 | TEKKAM HARISHI           | P | P | P | P | P | P | P | P | P | P | P | P | P | P | P | P | P | P | P | P | P | P | P | P | P | P | P | P | P | P |
| 32 | 13E31A0215 | GADDAM RAKESH            | P | P | P | P | P | P | P | P | P | P | P | P | P | P | P | P | P | P | P | P | P | P | P | P | P | P | P | P | P | P |
|    |            | Signature of the Faculty |   |   |   |   |   |   |   |   |   |   |   |   |   |   |   |   |   |   |   |   |   |   |   |   |   |   |   |   |   |   |

R. V. Varnath

Dept. of Electrical & Electronics E.  
 Acharya Institute of Science & Techno.  
 Wvasapuril, Bandlaguda, Kashwvtri,  
 Hyderabad - 500 005.



# MAHAVEER INSTITUTE OF SCIENCE AND TECHNOLOGY

(Affiliated to JNTU, Hyderabad and Approved by AICTE, New Delhi)  
Vyasapuri, Bandlaguda, Post: Keshavagiri, Hyderabad- 500005



organized by  
Department of Electrical and Electronics Engineering

## CERTIFICATE

This is certify that **Madugula Sai baba** bearing Hall Ticket No **14E35A021**  
**B.Tech Third Year** has Participated in **Importancy of Earthing Trainir**  
Program From **07-02-2017** to **20-02-2017** organized by **Department**  
**Electrical and Electronics Engineering.**

*R.V. Amarnath*

HOD  
Dr.R.V.Amarnath

*Dr. M. Rajendar Reddy*

Dr.M.Rajendar Reddy  
VITS

*Dr. K. S. S. S. N. R.*

PRINCIPAL  
Dr.K.S.S.S.N.R

*Dr. K. S. S. S. N. R.*

PRINCIPAL  
MAHAVEER INSTITUTE OF SCIENCE AND TECHNOLOGY  
BANDLAGUDA, HYDRABAD

Vysapur, Bandlaguda Post, Keshavnagar.

# MAHAVEER



Hyderabad-500 005, TELANGANA INDIA

Tel: 040-64596979, 8978380692 Fax: 040-24455903

E-mail: [ee3hod.eee@gmail.com](mailto:ee3hod.eee@gmail.com)

Website: [www.mist.ac.in](http://www.mist.ac.in)

Approved by AICTE Affiliated to JNTUH Hyd

## DEPARTMENT OF ELECTRICAL & ELECTRONICS

Date: 9-08-2016

To  
The Principal  
Mist,  
Hyderabad.

Sub-Proposal for Add on course-Reg.

Respected sir,

We are going to conduct two weeks workshop on **MULTISIM Programming**. We require your approval to go head for further proceeding and hope to get an opportunity to serve you the best.

With thanks and regards

HOD-EEE

Professor & HOD

Dept. of electrical & Electronics Engg  
Mahaveer Institute of Science & Technology

Vysapur, Bandlaguda, Keshavnagar

Hyderabad - 500 005.

PRINCIPAL  
MAHAVEER  
INSTITUTE OF SCIENCE & TECHNOLOGY  
Bandlaguda, Hyderabad - 500 005.



Vysapuri, Bandlaguda Post: Keshavgiri,

# MAHAVEER



Hyderabad-500 005, TELANGANA INDIA  
Tel: 040-64596979, 8978380692. Fax: 040-24455003  
E-mail: [e3hod.eee@gmail.com](mailto:e3hod.eee@gmail.com),  
Website: [www.mist.ac.in](http://www.mist.ac.in),

Approved by AICTE. Affiliated to JNTUH Hyd

## DEPARTMENT OF ELECTRICAL & ELECTRONICS

Date 009-08-2016

### CIRCULAR

Technical Trainings for II B. Tech students are starting from **16-08-2016** onwards. All HODs and placements coordinators have to manage the trainings and ensure 95% attendance all through the sessions.

All mentors need to send the compiled feedback report to HOD at [e3hod.eee@gmail.com](mailto:e3hod.eee@gmail.com) daily. Mentors are advised to take care of PNR (Students not participating in training).

Agenda: **Multisim Program**

Design & Development of Curriculum for Add on Courses Faculty names: Dr RV AMARNATH

2.G Prem kumar reddy

PRINCIPAL  
**MAHAVEER**  
INSTITUTE OF SCIENCE & TECHNOLOGY  
Bandlaguda, Hyd-500 005.

*R.V. Amarnath*  
HOD-EEE

Professor & Head  
Dept. of Electrical & Electronics Engg  
Mahaveer Institute of Science & Technology,  
Vysapuri, Bandlaguda, Keshavgiri,  
Hyderabad - 500 005.

Vysapuri, Bandlaguda Post:Keshavgiri,

# MAHAVEER



Hyderabad-500 005, TELANGANA INDIA

Tel: 040-64596979,8978380692 Fax: 040-24455803

E-mail: [ejhod.eee@gmail.com](mailto:ejhod.eee@gmail.com),

Website: [www.mist.ac.in](http://www.mist.ac.in),

Approved by AICTE Affiliated to JNTUH Hyd

## DEPARTMENT OF ELECTRICAL & ELECTRONICS

### SYLLABUS FOR Multisim Program

| SNO | TOPIC COVERED  | DURATION |
|-----|--|----------|
| 1   | Introduction   | 3        |
| 2   | Concept of multisim  | 3        |
| 3   | Feature of multisim  | 3        |
| 4   | commands of simulating software MULTISIM) circuit.               | 3        |
| 5   | Simulate of various combinational circuits                       | 3        |
| 6   | Series and parallel circuit of resistor Building a Business Case | 3        |
| 7   | inductor, capacitor and its combination in ac circuits           | 3        |
| 8   | Half wave, full wave and bridge                                  | 3        |
| 9   | power amplifier and oscillator                                   | 3        |
| 10  | Measurement of voltage and current in various electrical         | 3        |

*R.V Amavath*  
HOD-EEE

Professor & Head

Dept. of Electrical & Electronics Engg  
Mahaveer Institute of Science & Technology  
Vysapuri, Bandlaguda, Keshavgiri,  
Hyderabad - 500 005.

*K. K. K.*

PRINCIPAL  
MAHAVEER  
INSTITUTE OF SCIENCE & TECHNOLOGY  
Bandlaguda, Hyd-500-005.

Vysapuri, Bandlaguda Post, Keshavnagar,

# MAHAVEER



Hyderabad 500 005, TELANGANA INDIA

Tel: 040 64596979, 8978380692 Fax: 040 24455903

E-mail: e3hod.eee@gmail.com,

Website: www.mist.ac.in,

Approved by AICTE. Affiliated to JNTUH Hyd

## DEPARTMENT OF ELECTRICAL & ELECTRONICS

### LIST OF REGISTERED STUDENTS FOR Multisim Program

| SNO | HALL TICKET NO | NAME OF THE STUDENT           |
|-----|----------------|-------------------------------|
| 1   | 15E31A0201     | ADARI UMASHANKAR              |
| 2   | 15E31A0203     | ARRUM VAMSHIKRISHNA           |
| 3   | 15E31A0205     | B AKHILA                      |
| 4   | 15E31A0206     | BALLE ARAVIND KUMAR           |
| 5   | 15E31A0207     | BANOTH BALAJI                 |
| 6   | 15E31A0208     | BHUKYA PRAVALIKA              |
| 7   | 15E31A0209     | BURRA HARISH                  |
| 8   | 15E31A0210     | CHEVITI VINAY KUMAR           |
| 9   | 15E31A0211     | GANDI SAI KIRAN               |
| 10  | 15E31A0213     | GLDA AVINASH                  |
| 11  | 15E31A0216     | KASIREDDY SAI KIRAN REDDY     |
| 12  | 15E31A0217     | KATAKAM ANUDEEP KUMAR         |
| 13  | 15E31A0218     | KAVYA N                       |
| 14  | 15E31A0219     | KUPPILI ANUDEEP               |
| 15  | 15E31A0220     | KORUNARAJA AKHIL              |
| 16  | 15E31A0221     | KUCHIBOR PRANJITH DEEPRIDDY   |
| 17  | 15E31A0222     | KUSUNOJU MADHU                |
| 18  | 15E31A0224     | NADDIPALLI KANCHANA           |
| 19  | 15E31A0225     | NAKIDI ABHISHEK               |
| 20  | 15E31A0226     | NERLAKANTI NANDUWARDHAN REDDY |

PRINCIPAL  
MAHAVEER  
INSTITUTE OF TECHNOLOGY  
HYDERABAD 500 005



Vysapuri, Bandlaguda Post Keshavgi, Hyderabad-500 005, TELANGANA INDIA

# MAHAVEER



Tel: 040-64596979,8978380692 Fax: 040-24455003

E-mail: e3hod.eee@gmail.com

Website: www.mist.ac.in

Approved by AICTE. Affiliated to JNTUH Hyd

## DEPARTMENT OF ELECTRICAL & ELECTRONICS

|    |            |                           |
|----|------------|---------------------------|
| 21 | 15E31A0227 | RAHOD AMBADAS             |
| 22 | 15E31A0228 | SHIVANNAGARI BHASKARREDDY |
| 23 | 15E31A0229 | SILUSANI NAVYASRI         |
| 24 | 15E31A0230 | SODI SRIKRISHNA           |
| 25 | 15E31A0231 | THONGALA SHINEY           |
| 26 | 15E31A0232 | VOGULAPU RAJESH           |
| 27 | 15E31A0233 | YARUKALA SAI PRAKASH      |
| 28 | 15E31A0234 | J RAVI TEJA               |
| 29 | 16E35A0201 | ALLE J NISHITA            |
| 30 | 16E35A0202 | ERRALLA DEEPAK            |
| 31 | 16E35A0203 | JAKANAPALLY SHIRISHA      |
| 32 | 16E35A0204 | JALLA ANJANEYULU          |
| 33 | 16E35A0205 | KRISHNA TEJA ALLE J       |
| 34 | 16E35A0206 | CHITRALEKHA SURESH K      |
| 35 | 16E35A0207 | PURENARSI                 |
| 36 | 16E35A0208 | RAVULA PAVAN KUMAR        |
| 37 | 16E35A0209 | SURYA SRAVANTHI           |
| 38 | 16E35A0210 | VANGALA RANLETH KUMAR     |
| 39 | 16E35A0211 | YALAGANDULA DURGA DEVI    |

*Kishu*

PRINCIPAL  
**MAHAVEER**

MAHAVEER INSTITUTE OF SCIENCE & TECHNOLOGY  
BANDLAGUDA, HYD 500 005

*R.V.amma.th*

Professor & Head

Dept. of Electrical & Electronics Engg  
Mahaveer Institute of Science & Technology  
Vysapuri, Bandlaguda, Keshavgi,  
Hyderabad - 500 005.

Vysapuri, Bandlaguda Post:Keshavgiri,

# MAHAVEER



Hyderabad-500 005, TELANGANA INDIA

Tel: 040-64596979,8978380692 Fax: 040-24455903

E-mail: [e3hod.eee@gmail.com](mailto:e3hod.eee@gmail.com),

Website: [www.mist.ac.in](http://www.mist.ac.in),

Approved by AICTE Affiliated to JNTUH Hyd

## DEPARTMENT OF ELECTRICAL & ELECTRONICS

### Multisim Program QUESTION PAPER

Duration: 120 Minutes

4 X5 = 20 Marks

Answer the following all questions. Each question carries 5 marks.

1. How to resolve the issue in desmond ?
2. Explain the concept of multisim for coupled inductor dc-dc converter ?
3. Explain features included in multisim?
4. How to design control feedback loop to control duty cycle for voltage regulation of ac- dc conveter?

*Keshav*

PRINCIPAL  
MAHAVEER  
INSTITUTE OF SCIENCE & TECHNOLOGY  
Bandlaguda, Hyd-500 005.

*R.V. Anurath*  
HOD-EEE

PRINCIPAL & HOD  
Dept. of Electrical & Electronics Engg  
Mahaveer Institute of Science & Technology  
Vysapuri, Bandlaguda, Keshavgiri,  
Hyderabad - 500 005.

Vysapuri, Bandlaguda Post, Keshavnagar,

# MAHAVEER



Hyderabad-500 005, TELANGANA INDIA

Tel: 040-64596979,8978380692 Fax: 040-24455003

E-mail: [e3hod.eee@gmail.com](mailto:e3hod.eee@gmail.com)

Website: [www.mist.ac.in](http://www.mist.ac.in)

Approved by AICTE. Affiliated to JNTUH,Hyd

## DEPARTMENT OF ELECTRICAL & ELECTRONICS

### RESULT SHEET FOR Multicim Program REGISTERED STUDENTS

| SNO | ROLL TICKET NO | NAME OF THE STUDENT           | MARKS (20) | RESULT |
|-----|----------------|-------------------------------|------------|--------|
| 1   | 15E31A0201     | ADARUMASHANKAR                | 20         | PASS   |
| 2   | 15E31A0203     | ARRUM VAMSHIKRISHNA           | 19         | PASS   |
| 3   | 15E31A0205     | B AKHILA                      | 20         | PASS   |
| 4   | 15E31A0206     | BALLE ARAVIND KUMAR           | 18         | PASS   |
| 5   | 15E31A0207     | BANOJIBALAJI                  | 20         | PASS   |
| 6   | 15E31A0208     | BHUKYA PRAVALIKA              | 20         | PASS   |
| 7   | 15E31A0209     | BURRA HARISH                  | 19         | PASS   |
| 8   | 15E31A0210     | CHEVITH VINAY KUMAR           | 20         | PASS   |
| 9   | 15E31A0211     | GANDI SAI KIRAN               | 18         | PASS   |
| 10  | 15E31A0213     | GUDA AVINASHI                 | 20         | PASS   |
| 11  | 15E31A0216     | KASIREDDY SAI KIRAN REDDY     | 20         | PASS   |
| 12  | 15E31A0217     | KATAKAM ANUDEEP KUMAR         | 16         | PASS   |
| 13  | 15E31A0218     | KAVYA N                       | 20         | PASS   |
| 14  | 15E31A0219     | KOKKULA SAIKIRAN              | 20         | PASS   |
| 15  | 15E31A0220     | KOONARAPU AKHIL               | 17         | PASS   |
| 16  | 15E31A0221     | KUCHOOR PRANEETHDEEP REDDY    | 20         | PASS   |
| 17  | 15E31A0222     | KURUMATI SRI LAKSHMI          | 19         | PASS   |
| 18  | 15E31A0224     | NADDIPATI KRISHNA             | 17         | PASS   |
| 19  | 15E31A0225     | NAKIDI ABHISHEK               | 20         | PASS   |
| 20  | 15E31A0226     | NERLAKANTI NANDU ARDHAN REDDY | 20         | PASS   |
| 21  | 15E31A0227     | RATHOD AMBADAS                | 18         | PASS   |
| 22  | 15E31A0228     | SHIVANNAGARI BHASKARREDDY     | 20         | PASS   |
| 23  | 15E31A0229     | SILUSANI NAVYASRI             | 19         | PASS   |
| 24  | 15E31A0230     | SODI SRIKRISHNA               | 20         | PASS   |
| 25  | 15E31A0231     | THONGALA SHINEY               | 18         | PASS   |

*K. Srinivas*

PRINCIPAL  
MAHAVEER  
INSTITUTE OF SCIENCE & TECHNOLOGY



Vysapuri, Bandlaguda Post:Keshavgin,

# MAHAVEER



Hyderabad-500 005, TELANGANA INDIA

Tel: 040-64596979,8978380692 Fax: 040-24455003

E-mail: e3hod.eee@gmail.com,

Website: www.mist.ac.in,

Approved by AICTE. Affiliated to JNTUH,Hyd

## DEPARTMENT OF ELECTRICAL & ELECTRONICS

|    |            |                               |    |      |
|----|------------|-------------------------------|----|------|
| 26 | 15E31A0232 | VOGULAPU RAJESH               | 20 | PASS |
| 27 | 15E31A0233 | YARUKALA SAI PRAKASH          | 20 | PASS |
| 28 | 15E31A0234 | JRAVI TEJA                    | 16 | PASS |
| 29 | 16E35A0201 | ALE TI NISHITHA               | 20 | PASS |
| 30 | 16E35A0202 | ERRALLA DEEPAK                | 20 | PASS |
| 31 | 16E35A0203 | JAKANAPALLY SHIRISHA          | 20 | PASS |
| 32 | 16E35A0204 | JALLA ANJANEYULU              | 18 | PASS |
| 33 | 16E35A0205 | KRISHNATEJA ALE TI            | 19 | PASS |
| 34 | 16E35A0206 | PEDDA GOLLA SHIRISHA<br>YADAV | 18 | PASS |
| 35 | 16E35A0207 | PURI NARSING                  | 17 | PASS |
| 36 | 16E35A0208 | RAVULA PAVAN KUMAR            | 19 | PASS |
| 37 | 16E35A0209 | SURYA SRAVANTHI               | 19 | PASS |
| 38 | 16E35A0210 | VANGALA RANEE TH KUMAR        | 19 | PASS |
| 39 | 16E35A0211 | YALAGANDULA DURGA<br>DEVI     | 19 | PASS |

No. of students Registered:39

No. of students Passed:39

No. of students failed:NIL

PRINCIPAL  
MAHAVEER  
INSTITUTE OF SCIENCE & TECHNOLOGY  
Bandlaguda, Hyd-500 005.

R.V. Ananth

Professor in Charge  
Dept. of Electrical & Electronics Engineering  
Mahaveer Institute of Science & Technology  
Vysapuri, Bandlaguda, Keshavgin,  
Hyderabad - 500 005.

Vysapuri, Bandlaguda Post: Keshavgiri,

# MAHAVEER



Hyderabad-500 005, TELANGANA INDIA

Tel: 040-64596979,8978380692 Fax: 040-24455003

E-mail: [e3hod.eee@gmail.com](mailto:e3hod.eee@gmail.com)

Website: [www.mist.ac.in](http://www.mist.ac.in)

Approved by AICTE. Affiliated to JNTUH Hyd

## DEPARTMENT OF ELECTRICAL & ELECTRONICS

### SUMMARY REPORT OF Multisim Program

Objective: In the fast growing electrical field for understanding of installation of machinery, operation of any equipment, to do maintenance of any equipment and wiring of panel or buildings, knowledge of drawing reading and drawing making is required. For better understanding of various electrical circuit and working of components, knowledge of simulation software is required. Learning of software like CAD, PSIM and MULTISIM will enhance student's ability for working in this fast growing electrical market

  
COORDINATOR

Copy to

1. Department Notice Board
2. Principal for Information
3. Committee Members (Academic)



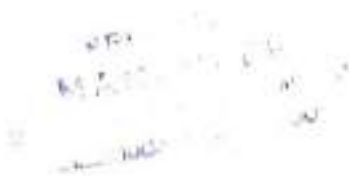

*Two week certificate course*

*011*

## Multisim programme

16<sup>th</sup> August–1st September, 2016)

Timings: 09.30 am to 11.30 am



Organized by



*Dept. of Electrical & Electronics Engineering*

**Mahaveer Institute of Science & Technology**

Vyasapuri, Bandlaguda, Hyderabad 500005.

(Affiliated to JNTUH)

### About the College

As an Institute committed to quality education **MIST** aims at providing learning with a technology edge. Right from its inception in **2001**, it has turning itself to meet this objective. It endeavors to provide consistent training to the students to help them evolve as competent professionals in the highly competitive world.

### About the Department

The Department of **Electrical & Electronics Engineering** was established in **2001** which offers **B.Tech, and M.Tech (POWER Engineering and Energy Systems)** courses with highly qualified, dedicated and motivated faculty. The courses and programmes offered by the department not only impart technical expertise to the students but also gives a professional experience.

### Organizing committee

#### *Chief Patrons*

Smt. S. Sudershan Reddy, Chairman, AIST

Sri S. Surendar Reddy, Secretary, AIST

Sri S. Dhanunjay Reddy, Joint Secretary, AIST

#### *Patron*

Dr. KSSSN Reddy, Principal, AIST

#### *Convener*

Dr. R.V. Anarnath, Professor, HoD EEE Dept.

#### *Co-convenor*

Mr. G. Prem Kumar Reddy, Assoc. Prof., EEE Dept.

#### *Program Coordinators*

Mr. A. MAHESH, Assistant Professor, EEE Dept.

Mr. G. Greshma, Assistant Professor, EEE Dept.

Mrs. R. KALYANI, Assistant Professor, EEE Dept.

Mr. B. SATISH, Assistant Professor, EEE Dept.

Mr. T. Ravibabu, Assistant Professor, EEE Dept.

Mr. P. Phaniendra, Assistant Professor, EEE Dept.

Mr. S. Suresh, Assistant Professor, EEE Dept.

### Course Details

- Introduction
- Concept of multism
- Feature of multism
- commands of simulating software (MULTISIM) circuit.
- Simulate of various combinational circuits
- Series and parallel circuit of resistor Building a Business Case
- inductor, capacitor and its combination in ac circuits

#### Resource Person

Mr. G. Srinivas

VITS

### Objectives of Workshop

**Objective:** In the fast growing electrical field for understanding of installation of machinery, operation of any equipment, to do maintenance of any equipment and wiring of panel or buildings, knowledge of drawing reading and drawing making is required. For better understanding of various electrical circuit and working of components, knowledge of simulation software is required. Learning of software like CAD, PSIM and MULTISIM will



9. Multisem Programming-2-11

| SNO | NO         | NAME OF THE STUDENT   | 1 | 2 | 3 | 4 | 5 | 6 | 7 | 8 | 9 | 10 | 11 | 12 | 13 | 14 | 15 | 16 | 17 | 18 | 19 | 20 | 21 | 22 | 23 | 24 | 25 | 26 | 27 | 28 | 29 | 30 |
|-----|------------|-----------------------|---|---|---|---|---|---|---|---|---|----|----|----|----|----|----|----|----|----|----|----|----|----|----|----|----|----|----|----|----|----|
| 1   | ISE31A0201 | ADARU MASHANKAR       | P | P | P | P | P | P | P | P | P | P  | P  | P  | P  | P  | P  | P  | P  | P  | P  | P  | P  | P  | P  | P  | P  | P  | P  | P  | P  | P  |
| 2   | ISE31A0203 | ARUL M VAMISHNKRISHNA | P | P | P | P | P | P | P | P | P | P  | P  | P  | P  | P  | P  | P  | P  | P  | P  | P  | P  | P  | P  | P  | P  | P  | P  | P  | P  | P  |
| 3   | ISE31A0205 | BAKHILA               | P | P | P | P | P | P | P | P | P | P  | P  | P  | P  | P  | P  | P  | P  | P  | P  | P  | P  | P  | P  | P  | P  | P  | P  | P  | P  | P  |
| 4   | ISE31A0206 | BALLE ARAVIND KUMAR   | P | P | P | P | P | P | P | P | P | P  | P  | P  | P  | P  | P  | P  | P  | P  | P  | P  | P  | P  | P  | P  | P  | P  | P  | P  | P  | P  |
| 5   | ISE31A0207 | BANOTH BALAJI         | P | P | P | P | P | P | P | P | P | P  | P  | P  | P  | P  | P  | P  | P  | P  | P  | P  | P  | P  | P  | P  | P  | P  | P  | P  | P  | P  |
| 6   | ISE31A0208 | BHENYA PRAYALINA      | P | P | P | P | P | P | P | P | P | P  | P  | P  | P  | P  | P  | P  | P  | P  | P  | P  | P  | P  | P  | P  | P  | P  | P  | P  | P  | P  |
| 7   | ISE31A0209 | BLERVA HARISH         | P | P | P | P | P | P | P | P | P | P  | P  | P  | P  | P  | P  | P  | P  | P  | P  | P  | P  | P  | P  | P  | P  | P  | P  | P  | P  | P  |
| 8   | ISE31A0210 | CHEVITYANAYAKI NIVAR  | P | P | P | P | P | P | P | P | P | P  | P  | P  | P  | P  | P  | P  | P  | P  | P  | P  | P  | P  | P  | P  | P  | P  | P  | P  | P  | P  |
| 9   | ISE31A0211 | GANDI SAIKIRAN        | P | P | P | P | P | P | P | P | P | P  | P  | P  | P  | P  | P  | P  | P  | P  | P  | P  | P  | P  | P  | P  | P  | P  | P  | P  | P  | P  |
| 10  | ISE31A0213 | GLDVA VINASHI         | P | P | P | P | P | P | P | P | P | P  | P  | P  | P  | P  | P  | P  | P  | P  | P  | P  | P  | P  | P  | P  | P  | P  | P  | P  | P  | P  |
| 11  | ISE31A0216 | KASIREDDY SAIKIRAN K  | P | P | P | P | P | P | P | P | P | P  | P  | P  | P  | P  | P  | P  | P  | P  | P  | P  | P  | P  | P  | P  | P  | P  | P  | P  | P  | P  |
| 12  | ISE31A0217 | KATAKAM ANUDEEP SAI   | P | P | P | P | P | P | P | P | P | P  | P  | P  | P  | P  | P  | P  | P  | P  | P  | P  | P  | P  | P  | P  | P  | P  | P  | P  | P  | P  |
| 13  | ISE31A0218 | KAVYAN                | P | P | P | P | P | P | P | P | P | P  | P  | P  | P  | P  | P  | P  | P  | P  | P  | P  | P  | P  | P  | P  | P  | P  | P  | P  | P  | P  |
| 14  | ISE31A0219 | KONKELA SAIKIRAN      | P | P | P | P | P | P | P | P | P | P  | P  | P  | P  | P  | P  | P  | P  | P  | P  | P  | P  | P  | P  | P  | P  | P  | P  | P  | P  | P  |
| 15  | ISE31A0221 | KUCHOOR PRANATHI DEVI | P | P | P | P | P | P | P | P | P | P  | P  | P  | P  | P  | P  | P  | P  | P  | P  | P  | P  | P  | P  | P  | P  | P  | P  | P  | P  | P  |
| 16  | ISE31A0222 | KESINOLE MAIDHE       | P | P | P | P | P | P | P | P | P | P  | P  | P  | P  | P  | P  | P  | P  | P  | P  | P  | P  | P  | P  | P  | P  | P  | P  | P  | P  | P  |
| 17  | ISE31A0224 | NADDIPALLEKANUNJANNA  | P | P | P | P | P | P | P | P | P | P  | P  | P  | P  | P  | P  | P  | P  | P  | P  | P  | P  | P  | P  | P  | P  | P  | P  | P  | P  | P  |
| 18  | ISE31A0225 | NANIDI ABHISHAN       | P | P | P | P | P | P | P | P | P | P  | P  | P  | P  | P  | P  | P  | P  | P  | P  | P  | P  | P  | P  | P  | P  | P  | P  | P  | P  | P  |
| 19  | ISE31A0228 | SHIVANNAGARI BHASKAR  | P | P | P | P | P | P | P | P | P | P  | P  | P  | P  | P  | P  | P  | P  | P  | P  | P  | P  | P  | P  | P  | P  | P  | P  | P  | P  | P  |
| 20  | ISE31A0229 | SILSANNANAVY ASHRI    | P | P | P | P | P | P | P | P | P | P  | P  | P  | P  | P  | P  | P  | P  | P  | P  | P  | P  | P  | P  | P  | P  | P  | P  | P  | P  | P  |
| 21  | ISE31A0230 | SODI SRKRISHNA        | P | P | P | P | P | P | P | P | P | P  | P  | P  | P  | P  | P  | P  | P  | P  | P  | P  | P  | P  | P  | P  | P  | P  | P  | P  | P  | P  |
| 22  | ISE31A0231 | THONGALASHINEY        | P | P | P | P | P | P | P | P | P | P  | P  | P  | P  | P  | P  | P  | P  | P  | P  | P  | P  | P  | P  | P  | P  | P  | P  | P  | P  | P  |
| 23  | ISE31A0233 | YARUKALASAI PRANAVANI | P | P | P | P | P | P | P | P | P | P  | P  | P  | P  | P  | P  | P  | P  | P  | P  | P  | P  | P  | P  | P  | P  | P  | P  | P  | P  | P  |
| 24  | ISE31A0234 | JRAVITEJA             | P | P | P | P | P | P | P | P | P | P  | P  | P  | P  | P  | P  | P  | P  | P  | P  | P  | P  | P  | P  | P  | P  | P  | P  | P  | P  | P  |
| 25  | ISE31A0236 | ALETINISHILA          | P | P | P | P | P | P | P | P | P | P  | P  | P  | P  | P  | P  | P  | P  | P  | P  | P  | P  | P  | P  | P  | P  | P  | P  | P  | P  | P  |
| 26  | ISE31A0203 | JAKANAPALLY SHIBHISHA | P | P | P | P | P | P | P | P | P | P  | P  | P  | P  | P  | P  | P  | P  | P  | P  | P  | P  | P  | P  | P  | P  | P  | P  | P  | P  | P  |
| 27  | ISE31A0204 | JAILVANANAYATHI       | P | P | P | P | P | P | P | P | P | P  | P  | P  | P  | P  | P  | P  | P  | P  | P  | P  | P  | P  | P  | P  | P  | P  | P  | P  | P  | P  |
| 28  | ISE31A0205 | KRISHNATEJA VIJETHI   | P | P | P | P | P | P | P | P | P | P  | P  | P  | P  | P  | P  | P  | P  | P  | P  | P  | P  | P  | P  | P  | P  | P  | P  | P  | P  | P  |
| 29  | ISE31A0206 | PEDDAGOLLA SIBHISHA   | P | P | P | P | P | P | P | P | P | P  | P  | P  | P  | P  | P  | P  | P  | P  | P  | P  | P  | P  | P  | P  | P  | P  | P  | P  | P  | P  |
| 30  | ISE31A0207 | PELIN NARSING         | P | P | P | P | P | P | P | P | P | P  | P  | P  | P  | P  | P  | P  | P  | P  | P  | P  | P  | P  | P  | P  | P  | P  | P  | P  | P  | P  |
| 31  | ISE31A0208 | RAYULA PAVAN KUMAR    | P | P | P | P | P | P | P | P | P | P  | P  | P  | P  | P  | P  | P  | P  | P  | P  | P  | P  | P  | P  | P  | P  | P  | P  | P  | P  | P  |
| 32  | ISE31A0209 | SURYA SRAVANTHI       | P | P | P | P | P | P | P | P | P | P  | P  | P  | P  | P  | P  | P  | P  | P  | P  | P  | P  | P  | P  | P  | P  | P  | P  | P  | P  | P  |
| 33  | ISE31A0210 | VANGALARANTHINI       | P | P | P | P | P | P | P | P | P | P  | P  | P  | P  | P  | P  | P  | P  | P  | P  | P  | P  | P  | P  | P  | P  | P  | P  | P  | P  | P  |
| 34  | ISE31A0211 | YALAGANDI LADIPRAGATA | P | P | P | P | P | P | P | P | P | P  | P  | P  | P  | P  | P  | P  | P  | P  | P  | P  | P  | P  | P  | P  | P  | P  | P  | P  | P  | P  |
| 35  | ISE31A0206 | RVENKATESH            | P | P | P | P | P | P | P | P | P | P  | P  | P  | P  | P  | P  | P  | P  | P  | P  | P  | P  | P  | P  | P  | P  | P  | P  | P  | P  | P  |
| 36  | ISE31A0208 | IDEVARATI             | P | P | P | P | P | P | P | P | P | P  | P  | P  | P  | P  | P  | P  | P  | P  | P  | P  | P  | P  | P  | P  | P  | P  | P  | P  | P  | P  |
| 37  | ISE31A0209 | DOMMATA BHASKAR       | P | P | P | P | P | P | P | P | P | P  | P  | P  | P  | P  | P  | P  | P  | P  | P  | P  | P  | P  | P  | P  | P  | P  | P  | P  | P  | P  |

Signature of the Faculty: *R. V. Venkatesh*

# MAHAVEER INSTITUTE OF SCIENCE AND TECHNOLOGY



(Affiliated to JNTUH, Hyderabad and Approved by AICTE, New Delhi)  
Vyasapuri, Bandlaguda, Post: Keshavagiri, Hyderabad- 500005

organized by

Department of Electrical and Electronics Engineering

## CERTIFICATE

This is certify that **K.Madhu** bearing Hall Ticket No **15E31A0222** of **B.T  
Second Year** has Participated in **Multisim Programming** Training Prog  
From 16-08-2016 to 29-08-2016 organized by **Department of Electrical  
Electronics Engineering.**

HOD  
Dr.R.V.Amarnath

G.Srinivas  
VITS

PRINCIPAL  
Dr.K.S.S.S.N.R

PRINCIPAL  
MAHAVEER INSTITUTE OF SCIENCE AND TECHNOLOGY  
BANDLAGUDA, HYDRABAD



### **About the College**

As an Institute committed in quality education, MIST aims at providing learning with a Technology-edge. It endeavors to provide consistent training to its students to help them evolve as competent professionals in the highly competitive world. Right from its inception in 2001, it has been tuning itself to meet this objective. A new civilization is emerging in our lives. This civilization brings with it a new way of working. Millions are already tuning their lives to the rhythms of tomorrow.

### **About the Mechanical Department**

The Mechanical engineering is one of the core engineering departments, which has potential to accommodate all efficient engineers. The Mechanical engineers serve all other branches of engineering directly or indirectly. The Mechanical engineers can find their place in Automobile engineering sector, Steel Plants, Power plants, Software industries, Manufacturing industries, Design industries, Military, Naval and Air force, Defense research organizations, Material research organizations etc.

### **About the Workshop**

AutoCAD is globally used by surveyors, designers, engineers, drafters. Globally, AutoCAD has proven as an efficient and user-friendly Program. Program Commercial drafting and computer-aided design(CAD) software applications are AutoCAD. AutoCAD software is recognized internationally for its remarkable editing capabilities, which make it likely to digitally draw building plans or recreate 3D images. AutoCAD is compatible with other applications like 3D Max. The designers can even import or export DWG & DXG Files to the application. Also, these files can even be exported from AutoCAD to other applications for creating more improved projects & presentations.

## **Organising committee**

### **CHIEF PATRON**

**Sri.S.Sudershan Reddy**

**Chairman**

**Sri. S. Surendar Reddy**

**Secretary**

**Sri S. Dhanunjay Reddy**

**Joint Secretary**

### **DIRECTOR**

**Dr. H. S. N. Murthy**

### **PATRON**

**Dr.K.S.S.S.Reddy, Principal**

### **CONVENER**

**Mr.G.K.Shanmukh Dev,**

**Asso. Prof, Dept. Of Mechanical**

### **PROGRAM COORDINATORS**

**Mr. B.Venkateswar Reddy**

**K.Devi Singh**

**Conducted On**

**02/5/2016- 12/5/2016**



# **MAHAVEER**

## **INSTITUTE OF SCIENCE & TECHNOLOGY**

Approved by AICTE, Affiliated to JNTU, Hyderabad.

Vyasapuri, Bandlaguda, Post: Keshavnagar, Hyderabad-500005.



**Two week  
Certification Course  
on**

# **Auto CAD**

*Organized by*

*Department of Mechanical  
Engineering*



Vysapuri, Bandlaguda Post, Keshavnagar,  
Hyderabad-500 005, Telangana INDIA  
Tel: 040-64596979, 20020773, Fax: 040-24455003  
E-mail: [principal.mahaveer@gmail.com](mailto:principal.mahaveer@gmail.com)  
Website: [www.mist.ac.in](http://www.mist.ac.in)

**MAHAVEER**



Approved by AICTE. Affiliated to JNTU-Hydr.

Date: 30-04-2016

To  
The Principal  
MIST,  
Hyderabad.

Sub: Proposal for Add-on Course-Reg.

Respected sir,

We are going to conduct 10 days Technical Training for II B. Tech students on "Introduction to Auto CAD". We require your approval to go head for proceeding and hope to get an opportunity to serve you the best.

With thanks and regards

G.K. Shanmukh Dev  
G.K. SHANMUKH DEV

HOD

Department of Mechanical Engineering

*Keshav*

PRINCIPAL  
MIST  
Keshavnagar, Hyderabad-500 005.

Vysapuri, Bandlaguda Post:Keshavgirl,  
Hyderabad-500 005, Telangana INDIA  
Tel: 040-64596979,20020773, Fax: 040-24455003  
E-mail: [principal.mahaveer@gmail.com](mailto:principal.mahaveer@gmail.com),  
Website: [www.mst.ac.in](http://www.mst.ac.in),

**MAHAVEER**  
INSTITUTE OF SCIENCE & TECHNOLOGY  
Approved by AICTE, Affiliated to JNTUH,Hyd.



Date: 30.04.2016

**CIRCULAR**

Technical Training for II B. Tech students are starting from 2<sup>nd</sup> MAY, 2020 onwards. All HODs and Placements coordinators have to manage the trainings and ensure 95% attendance all through the sessions.

All Mentors need to send the compiled feedback report to G.K.Shanmukh Dev, HOD at [e3hod.mech@gmail.com](mailto:e3hod.mech@gmail.com) daily.

Agenda: 1. Introduction to AUTOCAD.

**Design and Development of curriculum for Add on course:**

Name of the Faculty : B.VENKATESWAR REDDY

G.K. Shanmukh Dev  
G.K.SHANMUKH DEV

HOD

Department of Mechanical Engineering

*Keshav*  
PRINCIPAL  
MAHAVEER  
INSTITUTE OF SCIENCE & TECHNOLOGY  
Bandlaguda, Hyd-500 005.



## Auto CAD SYLLABUS

### 1: Getting Started with AutoCAD

- Opening and Creating Drawings
- Exploring the AutoCAD interface
- Zooming and Panning

### 2: Basic Drawing & Editing Commands

- Using the Mouse, Keyboard, and Enter Key to work quickly and efficiently in AutoCAD
- Lines
- Circles
- Rectangles

### 3: Projects - Creating a Simple Drawing

- Creating Simple Drawings
- Using Object Snap Tracking to extrapolate a projected top view
- Using Modify tools to arrange an office layout

### 4: Drawing Precision in AutoCAD

- Polar and Ortho Tracking
- Entering Coordinates and Angles
- Object Snaps and Tracking

### 5: Making Changes in Your Drawing

- Move
- Copy
- Rotate
- Mirror
- Scale
- Using the reference option with the Scale Tool

### 7: Organizing Your Drawing with Layers

- Layer States
- Properties by Layer
- Layer Tools

### 8: Advanced Object Types

- Polylines

*Handwritten signature*

*Handwritten text and stamp*





- Polygons
- Arcs
- Ellipses

## 9: Advanced Editing Commands

- Trim and Extend
- Fillet and Chamfer
- Polyline Edit and Spline
- Offset and Explode
- Join

## 10: Inserting Blocks

- The Insert Block Command
- Inserting Blocks with Tool Palettes
- Dynamic Bloes
- Migrating Blocks and other Elements between Drawings with Design Center

## 11: Text

- The Multiline Text Tool
- The Single Line Text Tool
- Editing Text
- Text in Model Space vs. Paper Space
- The Multileader Tool

## 12: Hatching

- The Hatch Command
- The Hatch Editor Ribbon Tab
- Saving and Applying Hatches with Tool Palettes

## 13: Adding Dimensions

- Using Dimensioning Tools
- Dimensioning in a Layout Tab vs. the Model Tab
- Using Dimension Styles
- Editing Dimensions

## 14. Projects - Annotating Your Drawing

- Dimensioning a Mechanical Drawing



## Department of Mechanical Engineering Auto CAD Technical Training student attendance list 2016-17

| SL.NO. | ROLL NO.   | NAME OF THE STUDENT         | YEAR |
|--------|------------|-----------------------------|------|
| 1      | 15E31A0301 | ABDUL ABRAR                 | II   |
| 2      | 15E31A0302 | ABDUL RAHMAN                | II   |
| 3      | 15E31A0303 | ANAND KUMAR                 | II   |
| 4      | 15E31A0304 | AQUEEB UDDIN FIRDUSH        | II   |
| 5      | 15E31A0305 | ATTLURI SURESH REDDY        | II   |
| 6      | 15E31A0306 | BANDA SATYA SHIVA REDDY     | II   |
| 7      | 15E31A0310 | BHOOMENI NARENDAR           | II   |
| 8      | 15E31A0311 | BICHKUNDA SUNIL KUMAR       | II   |
| 9      | 15E31A0313 | CHIDIRALA RAJKUMAR          | II   |
| 10     | 15E31A0315 | DESHAGOUNI MOHAN SAI        | II   |
| 11     | 15E31A0317 | GURRALA VENKATA NARSI REDDY | II   |
| 12     | 15E31A0318 | HUSSAIN FAIZ ULLAH          | II   |
| 13     | 15E31A0319 | K SAMPATH                   | II   |
| 14     | 15E31A0320 | KASIREDDY SAIMANOJ REDDY    | II   |
| 15     | 15E31A0321 | KATTA SRIKANTH REDDY        | II   |
| 16     | 15E31A0322 | KESHETTI NIKHIL             | II   |
| 17     | 15E31A0325 | M A LATEEF                  | II   |
| 18     | 15E31A0327 | MANCHIKANTI ARAVIND REDDY   | II   |
| 19     | 15E31A0329 | MD UBED UL RAHMAN           | II   |
| 20     | 15E31A0331 | MOHAMMED ABDULLAH ZUBAIR    | II   |
| 21     | 15E31A0332 | MOHAMMED AIJAZ              | II   |
| 22     | 15E31A0333 | MOHAMMED ISMAIL FURQAN      | II   |

*[Handwritten signature]*

Vysapuri, Bandlaguda Post Keshavnagar,  
Hyderabad-500 005, Telangana INDIA  
Tel: 040-64596979, 20020773, Fax: 040-24455003  
E-mail: [principal.mahaveer@gmail.com](mailto:principal.mahaveer@gmail.com)  
Website: [www.mist.ac.in](http://www.mist.ac.in)

# MAHAVEER



Approved by AICTE. Affiliated to JNTU(H)Hyd.

|    |            |                                   |    |
|----|------------|-----------------------------------|----|
| 23 | 15E31A0334 | MOHD ABDUL ATIF                   | II |
| 24 | 15E31A0336 | MOHD ASIM KHAN                    | II |
| 25 | 15E31A0337 | MOHD FARIHAN AHMED SHAREEF        | II |
| 26 | 15E31A0338 | MOHD SALA UDDIN                   | II |
| 27 | 15E31A0340 | MOHD TALHA                        | II |
| 28 | 15E31A0341 | MUDAVATH SRINIVAS                 | II |
| 29 | 15E31A0342 | NELLURI AJAY KUMAR                | II |
| 30 | 15E31A0343 | PADAMATINTI AVINASH               | II |
| 31 | 15E31A0344 | PALNATI SRIKANTH REDDY            | II |
| 32 | 15E31A0346 | POLAKA PARDHA SARADHI REDDY       | II |
| 33 | 15E31A0349 | SABHAVAT SEVYA                    | II |
| 34 | 15E31A0350 | SHADMAN ASHRAF                    | II |
| 35 | 15E31A0351 | SHAIK ABDUL SAIF                  | II |
| 36 | 15E31A0352 | SHAIK ARIF HUSSAIN                | II |
| 37 | 15E31A0354 | SOHAIL MOHAMMED MASOOD AHMED KHAN | II |
| 38 | 15E31A0356 | SYED BAHAUDDIN                    | II |
| 39 | 15E31A0360 | SYED QAMAR UDDIN RAZA SHAIQUADRI  | II |
| 40 | 15E31A0361 | SYED SHAHED AHMED                 | II |
| 41 | 15E31A0362 | T KULDEEP SINGH                   | II |
| 42 | 15E31A0363 | TANNEERU RAJA                     | II |
| 43 | 15E31A0365 | VANGAPALLY SRINIVAS               | II |
| 44 | 16E35A0301 | AMAR BIRADAR                      | II |
| 45 | 16E35A0302 | BHUKYA RAMA                       | II |
| 46 | 16E35A0303 | DHARAVATH RAVINDER NAYAK          | II |



Vysapuri, Bandlaguda Post Keshavnagar,  
Hyderabad-500 005, Telangana INDIA  
Tel: 040-64596979, 20020773, Fax: 040-24455003  
E-mail: [principal.mahaveer@gmail.com](mailto:principal.mahaveer@gmail.com),  
Website: [www.mist.ac.in](http://www.mist.ac.in)

# MAHAVEER



Approved by AICTE, Affiliated to JNTUH Hyd

|    |            |                              |    |
|----|------------|------------------------------|----|
| 47 | 16E35A0304 | EROJI SURESH                 | II |
| 48 | 16E35A0305 | GOURAV KUMAR JHA             | II |
| 49 | 16E35A0306 | KALIKOTA SAI CHARAN          | II |
| 50 | 16E35A0307 | MANYALA SAITEJA              | II |
| 51 | 16E35A0308 | TADEM BHARATH KUMAR          | II |
| 52 | 16E35A0310 | TANGELLA ASHOKA VARDHAN RAJU | II |
| 53 | 14E31A0303 | ANSAR AHMED KHAN             | II |
| 54 | 14E31A0334 | MOHAMMED ABRAR AHMED         | II |
| 55 | 14E31A0335 | MOHAMMED AKIF AHMED          | II |
| 56 | 14E31A0373 | G KARTHIK RAJ                | II |
| 57 | 14E31A0374 | A KAUSHIK VILAS              | II |
| 58 | 14E31A0386 | MOHAMMED SOHAIB              | II |
| 59 | 14E31A0397 | SYED SIKANDER ALI            | II |
| 60 | 14E31A0398 | SYED VIKAYAT ULLAH           | II |
| 61 | 15E35A0301 | E MADHUKAR                   | II |
| 62 | 13E31A0304 | AKASH HANVETHI               | II |
| 63 | 14E31A0390 | RAHUL SINGH                  | II |
| 64 | 14E31A0376 | IMAMD HASAN KHAN             | II |
| 65 | 14E31A0359 | TAMMARASHI AJAY KUMAR        | II |
| 66 | 13E31A0350 | S KUNAL                      | II |
| 67 | 14E31A0341 | MOHD KHAHA MOHIUDDIN         | II |
| 68 | 14E31A0352 | SAIFULLAH EKRAJ JALKOTE      | II |
| 69 | 14E31A0337 | MOHD ADNAN AZHAR             | II |
| 70 | 14E31A0339 | MOHD ABDUL HAMEED GOURI      | II |

*K. S. S.*  
PRINCIPAL  
MAHAVEER



Vasapur, Bandlaguda Post, Keshavnagar,  
Hyderabad-500 005, Telangana, INDIA  
Tel: 041-64596379, 20020773, Fax: 040-24415003  
E-mail: principal.mahaveer@gmail.com,  
Website: www.mst.ac.in

# MAHAVEER



Approved by AICTE, Affiliated to JNTU(Hydr)

**Department of Mechanical Engineering**  
**Auto CAD Technical Training student Marks list 2016-17**

| S.NO | Roll No    | Name of the student         | YEAR | MARKS | PASS/FAIL |
|------|------------|-----------------------------|------|-------|-----------|
| 1    | 15E31A0301 | ABDUL ABRAR                 | II   | 16    | PASS      |
| 2    | 15E31A0302 | ABDUL RAHMAN                | II   | 16    | PASS      |
| 3    | 15E31A0303 | ANAND KUMAR                 | II   | 12    | PASS      |
| 4    | 15E31A0304 | AQUEEB UDDIN FIRDUSH        | II   | 12    | PASS      |
| 5    | 15E31A0305 | ATTLURI SURESH REDDY        | II   | 16    | PASS      |
| 6    | 15E31A0306 | BANDA SATYA SHIVA REDDY     | II   | 16    | PASS      |
| 7    | 15E31A0310 | BHOOMENI NARENDHAR          | II   | 16    | PASS      |
| 8    | 15E31A0311 | BICKKUNDA SUNIL KUMAR       | II   | 16    | PASS      |
| 9    | 15E31A0313 | CHIDIRALA RAJKUMAR          | II   | 16    | PASS      |
| 10   | 15E31A0315 | DESHAGOUNI MOHAN SAI        | II   | 16    | PASS      |
| 11   | 15E31A0317 | GURRALA VENKATA NARSI REDDY | II   | 16    | PASS      |
| 12   | 15E31A0318 | HUSSAIN FAIZ ULLAH          | II   | 16    | PASS      |
| 13   | 15E31A0319 | K SAMPATH                   | II   | 16    | PASS      |
| 14   | 15E31A0320 | KASIREDDY SAIMANOJ REDDY    | II   | 16    | PASS      |
| 15   | 15E31A0321 | KATTA SRIKANTH REDDY        | II   | 16    | PASS      |
| 16   | 15E31A0322 | KESHETTI NIKHIL             | II   | 16    | PASS      |
| 17   | 15E31A0325 | M A LATEEF                  | II   | 16    | PASS      |
| 18   | 15E31A0327 | MANCHIKANTI ARAVIND REDDY   | II   | 16    | PASS      |
| 19   | 15E31A0329 | MD UBED UL RAHMAN           | II   | 15    | PASS      |
| 20   | 15E31A0331 | MOHAMMED ABDULLAH ZUBAIR    | II   | 16    | PASS      |
| 21   | 15E31A0332 | MOHAMMED AJAZ               | II   | 16    | PASS      |
| 22   | 15E31A0333 | MOHAMMED ISMAIL FURQAN      | II   | 15    | PASS      |
| 23   | 15E31A0334 | MOHD ABDUL ATIF             | II   | 16    | PASS      |

*Mahaveer*  
MAHAVEER  
Vasapur, Bandlaguda Post, Keshavnagar,  
Hyderabad-500 005, Telangana, INDIA



Vysapuri, Bandlaguda Post, Keshavnagar,  
Hyderabad 500 005, Telangana INDIA  
Tel: 040-64596979, 20020773, Fax: 040-24455003  
E-mail: principal.mahaveer@gmail.com  
Website: www.mst.ac.in

# MAHAVEER



Approved by AICTE, Affiliated to JNTUH Hyd

|    |            |                                   |    |    |      |
|----|------------|-----------------------------------|----|----|------|
| 24 | 15E31A0336 | MOHD ASIM KHAN                    | II | 14 | PASS |
| 25 | 15E31A0337 | MOHD FARHAN AHMED SHAREEF         | II | 15 | PASS |
| 26 | 15E31A0338 | MOHD SALA UDDIN                   | II | 15 | PASS |
| 27 | 15E31A0340 | MOHD TALHA                        | II | 16 | PASS |
| 28 | 15E31A0341 | MUDAVATH SRINIVAS                 | II | 14 | PASS |
| 29 | 15E31A0342 | NELLURI AJAY KUMAR                | II | 16 | PASS |
| 30 | 15E31A0343 | PADAMATINTI AVINASH               | II | 15 | PASS |
| 31 | 15E31A0344 | PALNATI SRIKANTH REDDY            | II | 14 | PASS |
| 32 | 15E31A0346 | POLAKA PARDHA SARADHI REDDY       | II | 18 | PASS |
| 33 | 15E31A0349 | SABHAVAT SEVYA                    | II | 15 | PASS |
| 34 | 15E31A0350 | SHADMAN ASHRAF                    | II | 16 | PASS |
| 35 | 15E31A0351 | SHAIK ABDUL SAIF                  | II | 15 | PASS |
| 36 | 15E31A0352 | SHAIK ARIF HUSSAIN                | II | 16 | PASS |
| 37 | 15E31A0354 | SOHAIL MOHAMMED MASOOD AHMED KHAN | II | 16 | PASS |
| 38 | 15E31A0356 | SYED BAHAUDDIN                    | II | 15 | PASS |
| 39 | 15E31A0360 | SYED QAMAR UDDIN RAZA SHAH QUADRI | II | 16 | PASS |
| 40 | 15E31A0361 | SYED SHAHED AHMED                 | II | 16 | PASS |
| 41 | 15E31A0362 | T KULDEEP SINGH                   | II | 15 | PASS |
| 42 | 15E31A0363 | TANNEERU RAJA                     | II | 16 | PASS |
| 43 | 15E31A0365 | VANGAPALLY SRINIVAS               | II | 14 | PASS |
| 44 | 16E35A0301 | AMAR BIRADAR                      | II | 15 | PASS |
| 45 | 16E35A0302 | BHUKYA RAMA                       | II | 15 | PASS |
| 46 | 16E35A0303 | DHARAVATH RAVINDER NAYAK          | II | 16 | PASS |
| 47 | 16E35A0304 | EROJI SURESH                      | II | 14 | PASS |
| 48 | 16E35A0305 | GOURAV KUMAR JHA                  | II | 16 | PASS |

**Mahaveer**  
Principal  
MAHAVEER  
Institute of Management Studies and Technology  
Bandlaguda, Hyderabad-500 005

Vysapuri, Bandlaguda Post:Keshavnagar,  
Hyderabad 500 005, Telangana INDIA.  
Tel: 040-64596979,20020773, Fax: 040-24455003  
E-mail: principal.mahaveer@gmail.com,  
Website: www.mist.ac.in,

# MAHAVEER



Approved by AICTE, Affiliated to JNTU-Hyd

|    |            |                              |    |    |      |
|----|------------|------------------------------|----|----|------|
| 49 | 16E35A0306 | KALIKOTA SAI CHARAN          | II | 15 | PASS |
| 50 | 16E35A0307 | MANYALA SAITEJA              | II | 14 | PASS |
| 51 | 16E35A0308 | TADEM BIHARATH KUMAR         | II | 18 | PASS |
| 52 | 16E35A0310 | TANGELLA ASHOKA VARDHAN RAJU | II | 15 | PASS |
| 53 | 14E31A0303 | ANSAR AHMED KHAN             | II | 16 | PASS |
| 54 | 14E31A0334 | MOHAMMED ABRAR AHMED         | II | 15 | PASS |
| 55 | 14E31A0335 | MOHAMMED AKIF AHMED          | II | 15 | PASS |
| 56 | 14E31A0373 | G KARTHIK RAJ                | II | 18 | PASS |
| 57 | 14E31A0374 | A KAUSHIK VILAS              | II | 15 | PASS |
| 58 | 14E31A0386 | MOHAMMED SOHAIB              | II | 16 | PASS |
| 59 | 14E31A0397 | SYED SIKANDER ALI            | II | 15 | PASS |
| 60 | 14E31A0398 | SYED VIKAYAT ULLAH           | II | 16 | PASS |
| 61 | 15E35A0301 | E MADHUKAR                   | II | 15 | PASS |
| 62 | 13E31A0304 | AKASH HANVETHI               | II | 16 | PASS |
| 63 | 14E31A0390 | RAHUL SINGH                  | II | 15 | PASS |
| 64 | 14E31A0376 | IMAMD HASAN KHAN             | II | 14 | PASS |
| 65 | 14E31A0359 | TAMMARASHI AJAY KUMAR        | II | 18 | PASS |
| 66 | 13E31A0350 | S KUNAL                      | II | 15 | PASS |
| 67 | 14E31A0341 | MOHD KHAFIA MOHIUDDIN        | II | 16 | PASS |
| 68 | 14E31A0352 | SAIFULLAH EKARAN JALKOTE     | II | 16 | PASS |
| 69 | 14E31A0337 | MOHD ADNAN AZHAR             | II | 15 | PASS |
| 70 | 14E31A0339 | MOHD ABDUL HAMEED GOURI      | II | 14 | PASS |





Vysapur, Bandlaguda Post Meshavrigi,  
Hyderabad-500 005, Telangana INDIA  
Tel: 040-64596979,20020773, Fax: 040-24455003  
E-mail: principal.mahaveer@gmail.com,  
Website: www.mist.ac.in,

**MAHAVEER**



Approved by AICTE. Affiliated to JNTU(Hyd)

## CERTIFICATE OF COURSE COMPLETION

This certificate is presented to Syed Bahauddin of MIST,  
who has successfully completed technical training course on "Auto  
CAD" held from 02-05-2016 to 12-05-2016 and found the  
student performance to be excellent.



ESTD : 2001

G.K. Shanmukh Dev  
G.K. SHANMUKH DEV

HOD

Department of Mechanical Engineering

*Handwritten signature*

Principal  
MIST  
Bandlaguda Post, Hyderabad-500 005.



## DEPARTMENT OF MECHANICAL ENGINEERING

### List of students enrolled in Auto CAD (2016-2017)

| S.No | Roll No    | Name of the student        | Date   |        |        |        |        |        |        |         |         |         |
|------|------------|----------------------------|--------|--------|--------|--------|--------|--------|--------|---------|---------|---------|
|      |            |                            | 2/5/16 | 3/5/16 | 4/5/16 | 5/5/16 | 6/5/16 | 7/5/16 | 9/5/16 | 10/5/16 | 11/5/16 | 12/5/16 |
| 1    | 15E31A0301 | ABDUL ABRAR                | P      | P      | P      | P      | P      | P      | P      | P       | P       | P       |
| 2    | 15E31A0302 | ABDUL RAHMAN               | P      | P      | P      | P      | P      | P      | P      | P       | P       | P       |
| 3    | 15E31A0303 | ANAND KUMAR                | P      | P      | P      | P      | P      | P      | P      | P       | P       | P       |
| 4    | 15E31A0304 | AQUEEB UDDIN<br>FIRDUSH    | P      | P      | P      | P      | P      | P      | P      | P       | P       | P       |
| 5    | 15E31A0305 | ATTLURI<br>SURESH REDDY    | P      | P      | P      | P      | P      | P      | P      | P       | P       | P       |
| 6    | 15E31A0306 | BANDA SATYA<br>SHIVA REDDY | P      | P      | P      | P      | P      | P      | P      | P       | P       | P       |
| 7    | 15E31A0310 | BHOOMENI<br>NARENDHAR      | P      | P      | P      | P      | P      | P      | P      | P       | P       | P       |
| 8    | 15E31A0311 | BICKUNDA<br>SUNIL KUMAR    | P      | P      | P      | P      | P      | P      | P      | P       | P       | P       |
| 9    | 15E31A0313 | CHIDIRALA<br>RAJKUMAR      | P      | P      | P      | P      | P      | P      | P      | P       | P       | P       |
| 10   | 15E31A0315 | DESHAGOUNI<br>MOHAN SAI    | P      | P      | P      | P      | P      | P      | P      | P       | P       | P       |

PRINCIPAL  
MAHAVEER  
INSTITUTE OF  
TECHNOLOGY  
BANDLAGUDA  
*Kishu*



## DEPARTMENT OF MECHANICAL ENGINEERING

### List of students enrolled in Auto CAD (2016-2017)

|    |            |                                   |   |   |   |   |   |   |   |   |   |   |
|----|------------|-----------------------------------|---|---|---|---|---|---|---|---|---|---|
| 11 | 15E31A0317 | GURRALA<br>VENKATA NARSI<br>REDDY | P | P | P | P | P | P | P | P | P | P |
| 12 | 15E31A0318 | HUSSAIN FAIZ<br>ULLAH             | P | P | P | P | P | P | P | P | P | P |
| 13 | 15E31A0319 | K SAMPATH                         | P | P | P | P | P | P | P | P | P | P |
| 14 | 15E31A0320 | KASIREDDY<br>SAIMANOJ<br>REDDY    | P | P | P | P | P | P | P | P | P | P |
| 15 | 15E31A0321 | KATTA<br>SRIKANTH<br>REDDY        | P | P | P | P | P | P | P | P | P | P |
| 16 | 15E31A0322 | KESHETTI<br>NIKHIL                | P | P | P | P | P | P | P | P | P | P |
| 17 | 15E31A0325 | M A LATEEF                        | P | P | P | P | P | P | P | P | P | P |
| 18 | 15E31A0327 | MANCHIKANTI<br>ARAVIND<br>REDDY   | P | P | P | P | P | P | P | P | P | P |
| 19 | 15E31A0329 | MD UBED UL<br>RAHMAN              | P | P | P | P | P | P | P | P | P | P |
| 20 | 15E31A0331 | MOHAMMED<br>ABDULLAH<br>ZUBAIR    | P | P | P | P | P | P | P | P | P | P |





## DEPARTMENT OF MECHANICAL ENGINEERING

### List of students enrolled in Auto CAD (2016-2017)

|    |            |                            |   |   |   |   |   |   |   |   |   |   |
|----|------------|----------------------------|---|---|---|---|---|---|---|---|---|---|
| 21 | 15E31A0332 | MOHAMMED AJAZ              | P | P | P | P | P | P | P | P | P | P |
| 22 | 15E31A0333 | MOHAMMED ISMAIL FURQAN     | P | P | P | P | P | P | P | P | P | P |
| 23 | 15E31A0334 | MOHD ABDUL ATIF            | P | P | P | P | P | P | P | P | P | P |
| 24 | 15E31A0336 | MOHD ASIM KHAN             | P | P | P | P | P | P | P | P | P | P |
| 25 | 15E31A0337 | MOHD FARIHAN AHMED SHAREEF | P | P | P | P | P | P | P | P | P | P |
| 26 | 15E31A0338 | MOHD SALA UDDIN            | P | P | P | P | P | P | P | P | P | P |
| 27 | 15E31A0340 | MOHD TALHA                 | P | P | P | P | P | P | P | P | P | P |
| 28 | 15E31A0341 | MUDAVATH SRINIVAS          | P | P | P | P | P | P | P | P | P | P |
| 29 | 15E31A0342 | NELLURI AJAY KUMAR         | P | P | P | P | P | P | P | P | P | P |
| 30 | 15E31A0343 | PADAMATINTI AVINASH        | P | P | P | P | P | P | P | P | P | P |
| 31 | 15E31A0344 | PALNATI SRIKANTH REDDY     | P | P | P | P | P | P | P | P | P | P |

APPROVED  
MAHVEER  
Principal  
Signature



DEPARTMENT OF MECHANICAL ENGINEERING

List of students enrolled in Auto CAD (2016-2017)

|    |            |  |   |   |   |   |   |   |   |   |   |   |
|----|------------|--|---|---|---|---|---|---|---|---|---|---|
| 32 | 15E31A0346 | POLAKA<br>PARDHA<br>SARADHI REDDY          | P | P | P | P | P | P | P | P | P | P |
| 33 | 15E31A0349 | SABHAVAT<br>SEVYA                          | P | P | P | P | P | P | P | P | P | P |
| 34 | 15E31A0350 | SHADMAN<br>ASHRAF                          | P | P | P | P | P | P | P | P | P | P |
| 35 | 15E31A0351 | SHAIK ABDUL<br>SAIF                        | P | P | P | P | P | P | P | P | P | P |
| 36 | 15E31A0352 | SHAIK ARIF<br>HUSSAIN                      | P | P | P | P | P | P | P | P | P | P |
| 37 | 15E31A0354 | SOHAIL<br>MOHAMMED<br>MASOOD AHMED<br>KHAN | P | P | P | P | P | P | P | P | P | P |
| 38 | 15E31A0356 | SYED<br>BAHAUDDIN                          | P | P | P | P | P | P | P | P | P | P |
| 39 | 15E31A0360 | SYED QAMAR<br>UDDIN RAZA<br>SHAH QUADRI    | P | P | P | P | P | P | P | P | P | P |
| 40 | 15E31A0361 | SYED SHAHED<br>AHMED                       | P | P | P | P | P | P | P | P | P | P |
| 41 | 15E31A0362 | T KULDEEP<br>SINGH                         | P | P | P | P | P | P | P | P | P | P |

*K. S. S. S.*



## DEPARTMENT OF MECHANICAL ENGINEERING

### List of students enrolled in Auto CAD (2016-2017)

|    |            |                              |   |   |   |   |   |   |   |   |   |   |
|----|------------|------------------------------|---|---|---|---|---|---|---|---|---|---|
| 42 | 15E31A0363 | TANNEERU RAJA                | P | P | P | P | P | P | P | P | P | P |
| 43 | 15E31A0365 | VANGAPALLY SRINIVAS          | P | P | P | P | P | P | P | P | P | P |
| 44 | 16E35A0301 | AMAR BIRADAR                 | P | P | P | P | P | P | P | P | P | P |
| 45 | 16E35A0302 | BHUKYA RAMA                  | P | P | P | P | P | P | P | P | P | P |
| 46 | 16E35A0303 | DHARAVATH RAVINDER NAYAK     | P | P | P | P | P | P | P | P | P | P |
| 47 | 16E35A0304 | EROJI SURESH                 | P | P | P | P | P | P | P | P | P | P |
| 48 | 16E35A0305 | GOURAV KUMAR JHA             | P | P | P | P | P | P | P | P | P | P |
| 49 | 16E35A0306 | KALIKOTA SAI CHARAN          | P | P | P | P | P | P | P | P | P | P |
| 50 | 16E35A0307 | MANYALA SAITEJA              | P | P | P | P | P | P | P | P | P | P |
| 51 | 16E35A0308 | TADEM BHARATHI KUMAR         | P | P | P | P | P | P | P | P | P | P |
| 52 | 16E35A0310 | TANGELLA ASHOKA VARDHAN RAJU | P | P | P | P | P | P | P | P | P | P |

PRINCIPAL  
MAHAVEER INSTITUTE OF SCIENCE AND TECHNOLOGY  
Kothavaram





## DEPARTMENT OF MECHANICAL ENGINEERING

### List of students enrolled in Auto CAD (2016-2017)

|    |            |                      |   |   |   |   |   |   |   |   |   |   |
|----|------------|----------------------|---|---|---|---|---|---|---|---|---|---|
| 53 | 14E31A0303 | ANSAR AHMED KHAN     | P | P | P | P | P | P | P | P | P | P |
| 54 | 14E31A0334 | MOHAMMED ABRAR AHMED | P | P | P | P | P | P | P | P | P | P |
| 55 | 14E31A0335 | MOHAMMED AKIF AHMED  | P | P | P | P | P | P | P | P | P | P |
| 56 | 14E31A0373 | G KARTHIK RAJ        | P | P | P | P | P | P | P | P | P | P |
| 57 | 14E31A0374 | A KAUSHIK VILAS      | P | P | P | P | P | P | P | P | P | P |
| 58 | 14E31A0386 | MOHAMMED SOHAIB      | P | P | P | P | P | P | P | P | P | P |
| 59 | 14E31A0397 | SYED SIKANDER ALI    | P | P | P | P | P | P | P | P | P | P |
| 60 | 14E31A0398 | SYED VIKAYAT ULLAH   | P | P | P | P | P | P | P | P | P | P |
| 61 | 15E35A0301 | E MADIUKAR           | P | P | P | P | P | P | P | P | P | P |
| 62 | 13E31A0304 | AKASH HANVETHI       | P | P | P | P | P | P | P | P | P | P |
| 63 | 14E31A0390 | RAHUL SINGH          | P | P | P | P | P | P | P | P | P | P |
| 64 | 14E31A0376 | IMAMD HASAN KHAN     | P | P | P | P | P | P | P | P | P | P |

*K. Srinivas*  
PRINCIPAL  
MAHAVEER  
INSTITUTE OF SCIENCE & TECHNOLOGY  
HYDERABAD



DEPARTMENT OF MECHANICAL ENGINEERING

List of students enrolled in Auto CAD (2016-2017)

|    |            |                             |   |   |   |   |   |   |   |   |   |   |
|----|------------|-----------------------------|---|---|---|---|---|---|---|---|---|---|
| 65 | 14E31A0359 | TAMMARASHI<br>AJAY KUMAR    | P | P | P | P | P | P | P | P | P | P |
| 66 | 13E31A0350 | S KUNAL                     | P | P | P | P | P | P | P | P | P | P |
| 67 | 14E31A0341 | MOHD KHAHA<br>MOHIUDDIN     | P | P | P | P | P | P | P | P | P | P |
| 68 | 14E31A0352 | SAIFULLAH<br>EKARAN JALKOTE | P | P | P | P | P | P | P | P | P | P |
| 69 | 14E31A0337 | MOHD ADNAN<br>AZHAR         | P | P | P | P | P | P | P | P | P | P |
| 70 | 14E31A0339 | MOHD ABDUL<br>HAMEED GOURI  | P | P | P | P | P | P | P | P | P | P |

*Abhis*  
PRINCIPAL  
MAHAVEER  
INSTITUTE OF SCIENCE & TECHNOLOGY  
VYSAPURI, BANDLAGUDA POST, KESHAVNAGAR,  
HYDERABAD-500 003, TELANGANA INDIA

### **About the College**

As an Institute committed in quality education, MIST aims at providing learning with a Technology-edge. It endeavors to provide consistent training to its students to help them evolve as competent professionals in the highly competitive world. Right from its inception in 2001, it has been tuning itself to meet this objective. A new civilization is emerging in our lives. This civilization brings with it a new way of working. Millions are already tuning their lives to the rhythms of tomorrow.

### **About the Mechanical Dept.**

The Mechanical engineering is one of the core engineering departments, which has potential to accommodate all efficient engineers. The Mechanical engineers serve all other branches of engineering directly or indirectly. The Mechanical engineers can find their place in Automobile engineering sector, Steel Plants, Power plants, Software industries, Manufacturing industries, Design industries, Military, Naval and Air force, Defense research organizations, Material research organizations etc.

### **About the Workshop**

CATIA delivers the unique ability not only to model any product, but to do so in the context of its real-life behavior: design in the age of experience. CATIA (Computer-Aided Three dimensional Interactive Application) software is a complete multi-platform solution for computer-aided design, manufacturing, engineering, 3D and PLM. Marketed by manufacturer Dassault Systèmes, the software is ideal for creating solids, surfaces, assemblies, drawings, fabrication and analysis. However, CATIA offers more advanced functionality for surfaces and modules for different industries.

### **Organizing committee**

#### **CHIEF PATRON**

**Sri.S.Sudershan Reddy**  
Chairman

**Sri. S. Surendar Reddy**  
Secretary

**Sri S. Dhanunjay Reddy**  
Joint Secretary

#### **DIRECTOR**

**Dr. H. S. N. Murthy**

#### **PATRON**

**Dr K.S.S.S.N Reddy, Principal**

#### **CONVENER**

**Mr.G.KShanmukhDev**

**Asso. Prof, Dept. Of Mechanical**

#### **PROGRAM COORDINATORS**

**Mr. G.K. ShanmukhDev**

**Mr.B.VenkateswarReddy**

#### **Duration**

02/05/2016-12/5/2016



ESTD: 2001

# **MAHAVEER**

## **INSTITUTE OF SCIENCE & TECHNOLOGY**

Approved by AICTE, Affiliated to JNTU, Hyderabad.  
Vyasapuri, Bandlaguda, Post: Keshavnagar, Hyderabad-500005.



**Two week  
Certification Course  
on**

# **Introduction to CATIA**

*Organized by*

*Department of Mechanical  
Engineering*



Vysapuri, Bandlaguda Post, Keshavnagar,  
Hyderabad-500 005, Telangana INDIA  
Tel: 040-64596979, 20020773, Fax: 040-24455003  
E-mail: [principal.mahaveer@gmail.com](mailto:principal.mahaveer@gmail.com)  
Website: [www.mist.ac.in](http://www.mist.ac.in)

**MAHAVEER**



Approved by AICTE. Affiliated to JNTUHYD

Date: 29-04-2016

To  
The Principal  
MIST,  
Hyderabad.

Sub: Proposal for Add-on Course-Reg.

Respected sir,

We are going to conduct 10 days Technical Training for III B. Tech students on "Introduction to CATIA". We require your approval to go head for proceeding and hope to get an opportunity to serve you the best.

With thanks and regards

*Kishu*

*G.K. Shanmukh Dev*  
G.K. SHANMUKH DEV

HOD

Department of Mechanical Engineering

PRINCIPAL  
MAHAVEER  
INSTITUTE OF TECHNOLOGY  
BANDLAGUDA, HYDERABAD-500005

Vysapuri, Bandlaguda Post Keshavnagar,  
Hyderabad-500 005, Telangana INDIA.  
Tel: 040-64596979,20020773, Fax: 040-24455003  
E-mail: [principal.mahaveer@gmail.com](mailto:principal.mahaveer@gmail.com)  
Website: [www.mist.ac.in](http://www.mist.ac.in)

**MAHAVEER**



Approved by AICTE. Affiliated to JNTU(Hydr)

Date: 30.04.2016

## CIRCULAR

Technical Training for III B. Tech students are starting from 2<sup>nd</sup> MAY, 2016 onwards. All HODs and Placements coordinators have to manage the trainings and ensure 95% attendance all through the sessions.

All Mentors need to send the compiled feedback report to G. K. Shanmukh Dev, HOD.

Agenda:

1. Introduction to CATIA.

**Design and Development of curriculum for Add on course:**

Name of the Faculty : 1. G.K.Shanmukh Dev

*Handwritten signature in blue ink.*

PRINCIPAL  
MAHAVEER  
INSTITUTE OF SCIENCE & TECHNOLOGY  
Bandlaguda  
Hyderabad-500 005

*Handwritten signature in black ink.*  
G.K.SHANMUKH DEV

HOD

Department of Mechanical Engineering



## CATIA SYLLABUS

Total Hours: 48

### I. Introduction:

- Modulus
- Features (powerful Tools
- Parametric modeling
- Feature based approach
- Parent – child Relationship)
- Associative and Model Centric
- b) Information about Interface
- Tools, Menu, etc.

### II. Sketcher:

- Getting Started
- Interface
- Sketch tools
- Profiles
- Operations
- Constraints
- Sketcher preferences
- References

### III. Part Features:

- Sketch Based Features
- Pad
- Pocket
- Thin
- Shaft
- Groove

*K. S. S. S.*

PRINCIPAL

MAHAVEER

INSTITUTE OF

Bandlaguda





- Hole
- Threaded Hole
- Rib
- Slot, Stiffener
- Multi section solid

#### IV. Dress-up Features

- Fillet
- Chamfer
- Draft
- Shell
- Thickness
- Thread/Tap

#### V. Reference Element

- Point
- Line
- Plane

#### VI. Assembly Modeling:

- Assembly Constraints
- Manipulation
- Defining a multi & fast multi-instantiation
- Analyzing an assembly

#### VII. Drafting:

- Sheets & Views
- View modification
- Generating dimensions
- Bill of material

Vysakh, Bandlaguda Post Keshavnagar,  
Hyderabad 500 005, Telangana INDIA  
Tel: 040 64596979, 20020773, Fax: 040 24455003  
E-mail: [principal.mahaveer@gmail.com](mailto:principal.mahaveer@gmail.com)  
Website: [www.mst.ac.in](http://www.mst.ac.in)

# MAHAVEER



Approved by AICTE, Affiliated to JNTU(Hydr)

- Dimensions
- Annotations
- Dress up Elements
- Properties
- Exporting and Importing files

*Kshiti*

PRINCIPAL  
MAHAVEER  
INSTITUTE OF SCIENCE & TECHNOLOGY  
Bandlaguda, Hyderabad 500 005.



## Department of Mechanical Engineering CATIA Technical Training student attendance list 2016-17

| S.NO. | ROLL NO    | NAME OF THE STUDENT            | YEAR |
|-------|------------|--------------------------------|------|
| 1     | 14E31A0301 | ALLI ARAVIND                   | III  |
| 2     | 14E31A0302 | ANNAPU PUSHPANJALI             | III  |
| 3     | 14E31A0306 | B KISHORE                      | III  |
| 4     | 14E31A0307 | B VISHNU                       | III  |
| 5     | 14E31A0308 | BALUSA VIVEK                   | III  |
| 6     | 14E31A0309 | BOTTU SAI MUKUND               | III  |
| 7     | 14E31A0310 | C SAI KIRAN                    | III  |
| 8     | 14E31A0311 | CHINTHIRALA NAGARJUNA          | III  |
| 9     | 14E31A0313 | DUDUKA SHIVAKUMAR              | III  |
| 10    | 14E31A0314 | DUSA YASHWANTH                 | III  |
| 11    | 14E31A0315 | EPPA RAGHU                     | III  |
| 12    | 14E31A0316 | ESUNATHI KALYAN                | III  |
| 13    | 14E31A0317 | GANGULA VINAY KUMAR REDDY      | III  |
| 14    | 14E31A0318 | GOPIDI ABHINAV REDDY           | III  |
| 15    | 14E31A0319 | GORIGE RAVIKANTH               | III  |
| 16    | 14E31A0320 | GOWLIKAR BHARGAV KUMAR         | III  |
| 17    | 14E31A0321 | JADALA VAMSHI KRISHNA          | III  |
| 18    | 14E31A0322 | JITENDRA SINGH                 | III  |
| 19    | 14E31A0323 | KATAPAAGA NIKHIL KALYAN        | III  |
| 20    | 14E31A0325 | KASOJU SAI KIRAN               | III  |
| 21    | 14E31A0326 | KATAKAM VINODKUMAR             | III  |
| 22    | 14E31A0327 | YAMINI SAI KUMAR               | III  |
| 23    | 14E31A0328 | KOTTALA SUSHMITHA              | III  |
| 24    | 14E31A0329 | KUCHANPALLY SANTHOSH REDDY     | III  |
| 25    | 14E31A0330 | MADDIBOENA SIVAPRAGATHILAKSHMI | III  |
| 26    | 14E31A0331 | MAMMAI AKHILESH                | III  |
| 27    | 14E31A0333 | MEDI AKHIL                     | III  |
| 28    | 14E31A0338 | MOHAMMED KHAN                  | III  |
| 29    | 14E31A0340 | MOHD AIJAZ KHAN                | III  |
| 30    | 14E31A0343 | MOTHAJIGARI VIJAY              | III  |
| 31    | 14E31A0346 | MUPPARAM SADHANA               | III  |
| 32    | 14E31A0347 | NEELI AKASH                    | III  |
| 33    | 14E31A0348 | P KRISHNA                      | III  |

*Handwritten signature*  
Principal  
MAHAVEER  
INSTITUTE OF ENGINEERING & TECHNOLOGY  
Bandlaguda Post, Keshavnagar, Hyderabad-500 025



Vysapuri, Bandlaguda Post Keshavnagar,  
Hyderabad 509 005, Telangana INDIA  
Tel: 040 64696979/20020773, Fax: 040-24465003  
E-mail: [principal.mahaveer@gmail.com](mailto:principal.mahaveer@gmail.com),  
Website: [www.mahaveer.ac.in](http://www.mahaveer.ac.in)

# MAHAVEER



Approved by AICTE Affiliated to JNTUHHyd

|    |            |                                |     |
|----|------------|--------------------------------|-----|
| 34 | 14E31A0349 | PALATHIRUKMANGADUDU            | III |
| 35 | 14E31A0353 | SHAIK AQIB                     | III |
| 36 | 14E31A0354 | SHAIK MOHAMMED RAYAN           | III |
| 37 | 14E31A0355 | SHAIK SOHAIL                   | III |
| 38 | 14E31A0358 | SYED MUZAMEEL ALI              | III |
| 39 | 14E31A0360 | VADLA PRASHANTH                | III |
| 40 | 14E31A0361 | AMIT KUMAR PANDEY              | III |
| 41 | 14E31A0363 | ARROJU SHRAVANKUMAR            | III |
| 42 | 14E31A0365 | BOMMARAJU SAIKUMAR             | III |
| 43 | 14E31A0367 | FAZAL AHMED KAMIL              | III |
| 44 | 14E31A0369 | G RAGHUVERDHAN REDDY           | III |
| 45 | 14E31A0372 | GORIGE NARENDER                | III |
| 46 | 14E31A0377 | JAMALPUR ADITHYA               | III |
| 47 | 14E31A0378 | KADAVENDI ARAVIND              | III |
| 48 | 14E31A0380 | KOPPULA NARESH REDDY           | III |
| 49 | 14E31A0382 | MA RAHEMAN                     | III |
| 50 | 14E31A0383 | MD MUQTAR AHMED KHAN           | III |
| 51 | 14E31A0384 | MOHAMMED ABDUL RAHEMAN         | III |
| 52 | 14E31A0385 | MOHAMMED OMER                  | III |
| 53 | 14E31A0387 | MOHAMMED AKBAR                 | III |
| 54 | 14E31A0388 | MOHD FAROOQ                    | III |
| 55 | 14E31A0389 | MOHD SOHAIL                    | III |
| 56 | 14E31A0391 | N VINESH REDDY                 | III |
| 57 | 14E31A0392 | NANDIGAM SURENDRA              | III |
| 58 | 14E31A0393 | PITLA SWAMY                    | III |
| 59 | 14E31A0396 | RINIU GEORGE                   | III |
| 60 | 14E31A03A0 | VAIDURI KRISHNA                | III |
| 61 | 14E31A03A1 | YERRA ARVIND REDDY             | III |
| 62 | 14E31A03A2 | SHEOB AHMED                    | III |
| 63 | 14E31A03A3 | SYED MD AHMED MOHIUDDIN QUADRI | III |
| 64 | 13E31A0380 | MOHD FARHAN UDDIN              | III |
| 65 | 15E35A0302 | H AKHILESH                     | III |
| 66 | 15E35A0303 | HEEREKAR RAHUL                 | III |
| 67 | 15E35A0304 | MAMIDIGA NAGESH                | III |
| 68 | 15E35A0305 | MD SHOEB AKRAM                 | III |
| 69 | 15E35A0307 | MYAKALA SHIVAKUMAR             | III |
| 70 | 15E35A0308 | SYED ASHFAQ                    | III |
| 71 | 13E31A0318 | C VENKATESH                    | III |

*Kanhu*

PRINCIPAL  
MAHAVEER  
INSTITUTE OF MANAGEMENT STUDIES  
HYDRABAD



## Technical Training Exam on Catia Software (A.Y-2016-17)

2x10=20 Marks

### Answer All the Questions

1. Draw the given figure by using Catia software.

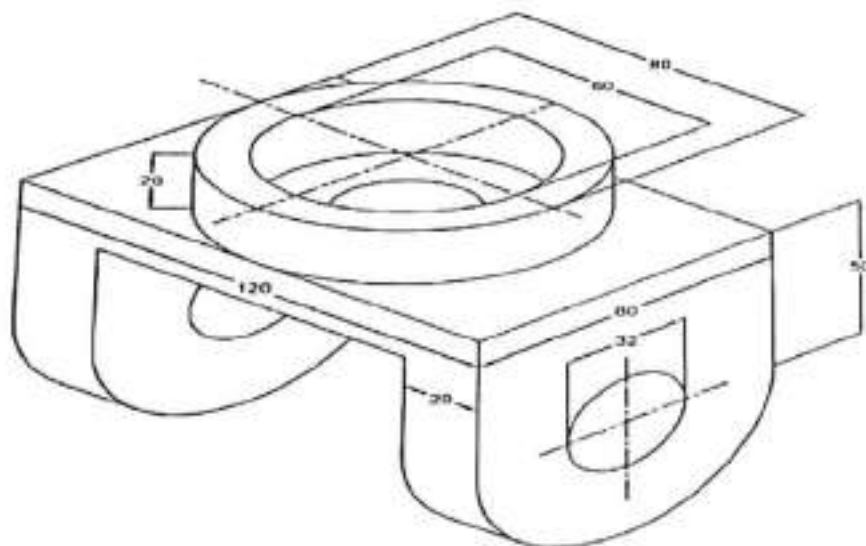

2. Draw the given 2D model into 3D model by using Catia.

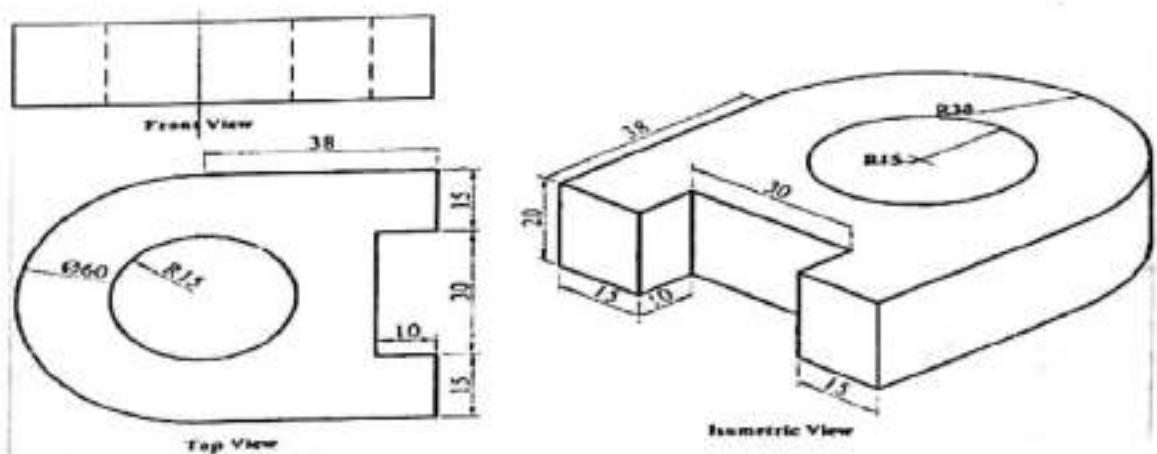

*Handwritten signature and stamp:*  
Principal  
Mahaveer Institute of Technology  
Bandlaguda Post, Keshavgiri  
Hyderabad-506 905

Vysapur, Bandlaguda Post, Keshavnagar,  
Hyderabad-500 005, Telangana INDIA  
Tel: 040-64596379, 20020773, Fax: 040-24455003  
E-mail: [principal@mahaveer.org](mailto:principal@mahaveer.org)  
Website: [www.mst.ac.in](http://www.mst.ac.in)

# MAHAVEER



Approved by AICTE - Affiliated to JNTU-Hydr

## Department of Mechanical Engineering CATIA Technical Training student Marks list 2016-17

| Sl.NO | Roll No    | Name of the student            | YEAR | MARKS | PASS/FAIL |
|-------|------------|--------------------------------|------|-------|-----------|
| 1     | 14E31A0301 | ALLI ARAVIND                   | III  | 15    | PASS      |
| 2     | 14E31A0302 | ANNAPU PUSHIPANJALI            | III  | 16    | PASS      |
| 3     | 14E31A0306 | B KISHORE                      | III  | 18    | PASS      |
| 4     | 14E31A0307 | B VISHNU                       | III  | 15    | PASS      |
| 5     | 14E31A0308 | BALUSA VIVEK                   | III  | 15    | PASS      |
| 6     | 14E31A0309 | BOTTU SAI MUKUND               | III  | 15    | PASS      |
| 7     | 14E31A0310 | C SAI KIRAN                    | III  | 16    | PASS      |
| 8     | 14E31A0311 | CHINTHIRALA NAGARJUNA          | III  | 15    | PASS      |
| 9     | 14E31A0313 | DUDUKA SHIVAKUMAR              | III  | 16    | PASS      |
| 10    | 14E31A0314 | DUSA YASHWANTH                 | III  | 12    | PASS      |
| 11    | 14E31A0315 | EPPA RAGHU                     | III  | 15    | PASS      |
| 12    | 14E31A0316 | ESUNATHI KALYAN                | III  | 16    | PASS      |
| 13    | 14E31A0317 | GANGULA VINAY KUMAR REDDY      | III  | 12    | PASS      |
| 14    | 14E31A0318 | GOPIDI ABHINAV REDDY           | III  | 15    | PASS      |
| 15    | 14E31A0319 | GORIGE RAVIKANTH               | III  | 16    | PASS      |
| 16    | 14E31A0320 | GOWLIKAR BHARGAV KUMAR         | III  | 14    | PASS      |
| 17    | 14E31A0321 | JADALA VAMSHI KRISHNA          | III  | 15    | PASS      |
| 18    | 14E31A0322 | JITENDRA SINGH                 | III  | 17    | PASS      |
| 19    | 14E31A0323 | KATAPAAGA NIKHIL KALYAN        | III  | 15    | PASS      |
| 20    | 14E31A0325 | KASOJU SAI KIRAN               | III  | 16    | PASS      |
| 21    | 14E31A0326 | KATAKAM VINODKUMAR             | III  | 16    | PASS      |
| 22    | 14E31A0327 | YAMINI SAI KUMAR               | III  | 15    | PASS      |
| 23    | 14E31A0328 | KOTTALA SUSHMITHA              | III  | 16    | PASS      |
| 24    | 14E31A0329 | KUCHANPALLY SANTHOSH REDDY     | III  | 14    | PASS      |
| 25    | 14E31A0330 | MADDIBOENA SIVAPRAGATHILAKSHMI | III  | 15    | PASS      |
| 26    | 14E31A0331 | MAMMAI AKHILESH                | III  | 15    | PASS      |
| 27    | 14E31A0333 | MEDI AKHIL                     | III  | 16    | PASS      |
| 28    | 14E31A0338 | MOHAMMED KHAN                  | III  | 14    | PASS      |
| 29    | 14E31A0340 | MOHD AJAZ KHAN                 | III  | 15    | PASS      |
| 30    | 14E31A0343 | MOTHAJIGARI VIJAY              | III  | 15    | PASS      |
| 31    | 14E31A0346 | MUPPARAM SADHANA               | III  | 14    | PASS      |

*Kanhu*  
Principal  
MAHVEER  
INSTITUTE OF  
TECHNOLOGY  
Bandlaguda - 500 005



Vysport, Bandlaguda Post, Kanchugiri,  
Hyderabad 500 001, Telangana-500001  
Tel: 040-64509979, 20026771 Fax: 040-24498003  
E-mail: principal.mahaveer@gmail.com  
Website: www.mv, ac.in

# MAHAVEER



Approved by A.C.TE. Accredited: D21334HY1

|    |            |             |     |    |      |
|----|------------|-------------|-----|----|------|
| 70 | 15E35A0308 | SYED ASHEAQ | III | 16 | PASS |
| 71 | 13E31A0318 | C VENKATESH | III | 17 | PASS |

*Kishu*  
PRINCIPAL  
MAHAVEER  
PRINCE OF EDUCATION  
Bandlaguda, Hyderabad



## CATIA COURSE

### Summary

- In this course, you will learn how to utilize the core functionality enhancements in Catia.
- First, you will become familiar with using and customizing the new ribbon interface in Catia.
- The new measure and sectioning interfaces will also be examined. Next, you will become familiar with the Sketcher workflow and reference enhancements.
- Part modeling enhancements to features such as Extrude, Corner Chamfer, Sweeps, Blends, and Datum Curves will then be examined.
- You will also learn about new and enhanced Assembly capabilities, such as selecting multiple components, the new relationship constraints, and enhancements for dragging components.
- Then, you will examine the new Table and Balloon functionality for 2-D drawings, and review various detailing enhancements.
- At the end of each module, you will complete a set of review questions to reinforce critical topics from that module. At the end of the course, you will complete a course assessment in Catia intended to evaluate your understanding of the course as a whole.

Copy to :

1. Department of Notice Board
2. Principal for Information
3. Committee Members (Academic)

  
MAHAVEER  
INSTITUTE OF TECHNOLOGY  
BANDLAGUDA, HYD-500 005.

Vysavuri, Bandlaguda Post Keshavnagar,  
Hyderabad 500 005, Telangana INDIA  
Tel: 040-64596979, 20020773, Fax: 040-24455003  
E-mail: principal.mahaveer@gmail.com  
Website: www.mist.ac.in

# MAHAVEER



Approved by AICTE. Affiliated to JNTUHY1

## CERTIFICATE OF COURSE COMPLETION

This certificate is presented to N. Akash of  
MIST, who has successfully completed technical training course on  
"CATIA" held from 02-05-2016 to 12-05-2016 and found the  
student performance to be excellent.

*Principal*  
MAHAVEER  
INSTITUTE OF SCIENCE & TECHNOLOGY  
VYSAVURI, BANDLAGUDA, HYD-500005



ESTD : 2001

*G.K. Shanmukh Dev*  
G.K. SHANMUKH DEV

HOD

Department of Mechanical Engineering





## DEPARTMENT OF MECHANICAL ENGINEERING

### List of students enrolled in CATIA (2016-2017)

| S.No                | Roll No    | Date                   |         |      |     |      |      |      |      |     |      |      |   |   |
|---------------------|------------|------------------------|---------|------|-----|------|------|------|------|-----|------|------|---|---|
|                     |            |                        | 21/5/16 | 27/5 | 4/5 | 11/5 | 18/5 | 25/5 | 31/5 | 7/6 | 14/6 | 21/6 |   |   |
| Name of the student |            |                        |         |      |     |      |      |      |      |     |      |      |   |   |
| 1                   | 14E31A0301 | ALLI ARAVIND           | P       | P    | P   | P    | P    | P    | P    | P   | P    | P    | P | P |
| 2                   | 14E31A0302 | ANNAPU PUSHANALI       | P       | P    | P   | P    | P    | P    | P    | P   | P    | P    | P | P |
| 3                   | 14E31A0306 | B KISHORE              | P       | P    | P   | P    | P    | P    | P    | P   | P    | P    | P | P |
| 4                   | 14E31A0307 | B VISHNU               | P       | P    | P   | P    | P    | P    | P    | P   | P    | P    | P | P |
| 5                   | 14E31A0308 | BALUSA VIVEK           | P       | P    | P   | P    | P    | P    | P    | P   | P    | P    | P | P |
| 6                   | 14E31A0309 | BOTTU SAI MUKUND       | P       | P    | P   | P    | P    | P    | P    | P   | P    | P    | P | P |
| 7                   | 14E31A0310 | C SAI KIRAN            | P       | P    | P   | P    | P    | P    | P    | P   | P    | P    | P | P |
| 8                   | 14E31A0311 | CHINTHIRALA NAGARJUNA  | P       | P    | P   | P    | P    | P    | P    | P   | P    | P    | P | P |
| 9                   | 14E31A0313 | DUDUKA SHIVAKUMAR      | P       | P    | P   | P    | P    | P    | P    | P   | P    | P    | P | P |
| 10                  | 14E31A0314 | DUSA YASHWANTH         | P       | P    | P   | P    | P    | P    | P    | P   | P    | P    | P | P |
| 11                  | 14E31A0315 | EPPA RAGHU             | P       | P    | P   | P    | P    | P    | P    | P   | P    | P    | P | P |
| 12                  | 14E31A0316 | ESUNATHI KALYAN        | P       | P    | P   | P    | P    | P    | P    | P   | P    | P    | P | P |
| 13                  | 14E31A0317 | G VINAY KUMAR REDDY    | P       | P    | P   | P    | P    | P    | P    | P   | P    | P    | P | P |
| 14                  | 14E31A0318 | GOPIDI ABHINAV REDDY   | P       | P    | P   | P    | P    | P    | P    | P   | P    | P    | P | P |
| 15                  | 14E31A0319 | GORIGE RAVIKANSH       | P       | P    | P   | P    | P    | P    | P    | P   | P    | P    | P | P |
| 16                  | 14E31A0320 | GOWLIKAR BHARGAV KUMAR | P       | P    | P   | P    | P    | P    | P    | P   | P    | P    | P | P |
| 17                  | 14E31A0321 | JADALA VAMSHI KRISHNA  | P       | P    | P   | P    | P    | P    | P    | P   | P    | P    | P | P |
| 18                  | 14E31A0322 | JITENDRA SINGH         | P       | P    | P   | P    | P    | P    | P    | P   | P    | P    | P | P |
| 19                  | 14E31A0323 | K NIKHIL KALYAN        | P       | P    | P   | P    | P    | P    | P    | P   | P    | P    | P | P |

*Kishu!*  
PRINCIPAL  
MAHAVEER  
INSTITUTE OF TECHNOLOGY & ENGINEERING  
Hyderabad, India



## DEPARTMENT OF MECHANICAL ENGINEERING

### List of students enrolled in CATIA (2016-2017)

|    |            |                        |   |   |   |   |   |   |   |   |   |   |
|----|------------|------------------------|---|---|---|---|---|---|---|---|---|---|
| 20 | 14E31A0325 | KASOJU SAIKIRAN        | P | P | P | P | P | P | P | P | P | P |
| 21 | 14E31A0326 | KATAKAM VINODKUMAR     | P | P | P | P | P | P | P | P | P | P |
| 22 | 14E31A0327 | YAMINI SAIKUMAR        | P | P | P | P | P | P | P | P | P | P |
| 23 | 14E31A0328 | KOTTALA SUSHMIHA       | P | P | P | P | P | P | P | P | P | P |
| 24 | 14E31A0329 | K SANTHOSH REDDY       | P | P | P | P | P | P | P | P | P | P |
| 25 | 14E31A0330 | M SIVAPRAGATHI LAKSHMI | P | P | P | P | P | P | P | P | P | P |
| 26 | 14E31A0331 | MAMMAIAKHILESH         | P | P | P | P | P | P | P | P | P | P |
| 27 | 14E31A0333 | MEDI AKHIL             | P | P | P | P | P | P | P | P | P | P |
| 28 | 14E31A0338 | MOHAMMED KHAN          | P | P | P | P | P | P | P | P | P | P |
| 29 | 14E31A0340 | MOHD AJAZ KHAN         | P | P | P | P | P | P | P | P | P | P |
| 30 | 14E31A0343 | MOTHAJIGARI VIJAY      | P | P | P | P | P | P | P | P | P | P |
| 31 | 14E31A0346 | MUPPARAM SADIYANA      | P | P | P | P | P | P | P | P | P | P |
| 32 | 14E31A0347 | NEELI AKASH            | P | P | P | P | P | P | P | P | P | P |
| 33 | 14E31A0348 | P KRISHNA              | P | P | P | P | P | P | P | P | P | P |
| 34 | 14E31A0349 | PALATI RUKMANJADUDU    | P | P | P | P | P | P | P | P | P | P |
| 35 | 14E31A0353 | SHAIK AQIB             | P | P | P | P | P | P | P | P | P | P |
| 36 | 14E31A0354 | SHAIK MOHAMMED RAYAN   | P | P | P | P | P | P | P | P | P | P |
| 37 | 14E31A0355 | SHAIK SOHAIL           | P | P | P | P | P | P | P | P | P | P |
| 38 | 14E31A0358 | SYED MUZAMEEL ALI      | P | P | P | P | P | P | P | P | P | P |
| 39 | 14E31A0360 | VADLA PRASHANTH        | P | P | P | P | P | P | P | P | P | P |
| 40 | 14E31A0361 | AMIT KUMAR PANDEY      | P | P | P | P | P | P | P | P | P | P |
| 41 | 14E31A0363 | ARROJU SHRAVANKUMAR    | P | P | P | P | P | P | P | P | P | P |





## DEPARTMENT OF MECHANICAL ENGINEERING

### List of students enrolled in CATIA (2016-2017)

|    |            |                        |   |   |   |   |   |   |   |   |   |   |
|----|------------|------------------------|---|---|---|---|---|---|---|---|---|---|
| 42 | 14E31A0365 | BOMMARAJU SAIKUMAR     | P | P | P | P | P | P | P | P | P | P |
| 43 | 14E31A0367 | FAZAL AHMED KAMIL      | P | P | P | P | P | P | P | P | P | P |
| 44 | 14E31A0369 | G RAGHUVERDIAN REDDY   | P | P | P | P | P | P | P | P | P | P |
| 45 | 14E31A0372 | GORIGE NARENDER        | P | P | P | P | P | P | P | P | P | P |
| 46 | 14E31A0377 | JAMALPUR ADITHYAN      | P | P | P | P | P | P | P | P | P | P |
| 47 | 14E31A0378 | KADAVENDI ARAVIND      | P | P | P | P | P | P | P | P | P | P |
| 48 | 14E31A0380 | KOPPULA NARESH REDDY   | P | P | P | P | P | P | P | P | P | P |
| 49 | 14E31A0382 | MA RAHEMAN             | P | P | P | P | P | P | P | P | P | P |
| 50 | 14E31A0383 | MD MUQTAR AHMED KHAN   | P | P | P | P | P | P | P | P | P | P |
| 51 | 14E31A0384 | MOHAMMED ABDEL RAHEMAN | P | P | P | P | P | P | P | P | P | P |
| 52 | 14E31A0385 | MOHAMMED OMAR          | P | P | P | P | P | P | P | P | P | P |
| 53 | 14E31A0387 | MOHAMMED AKHAR         | P | P | P | P | P | P | P | P | P | P |
| 54 | 14E31A0388 | MOHD FAROOQ            | P | P | P | P | P | P | P | P | P | P |
| 55 | 14E31A0389 | MOHD SOHAIB            | P | P | P | P | P | P | P | P | P | P |
| 56 | 14E31A0391 | N VINESH REDDY         | P | P | P | P | P | P | P | P | P | P |
| 57 | 14E31A0392 | NANDIGAM SURENDRA      | P | P | P | P | P | P | P | P | P | P |
| 58 | 14E31A0393 | PITLA SWAMY            | P | P | P | P | P | P | P | P | P | P |
| 59 | 14E31A0396 | RINJU GEORGE           | P | P | P | P | P | P | P | P | P | P |
| 60 | 14E31A03A0 | VADLURI KRISHNA        | P | P | P | P | P | P | P | P | P | P |
| 61 | 14E31A03A1 | YERRA ARVIND REDDY     | P | P | P | P | P | P | P | P | P | P |

*Kishu*

MAHAVEER  
INSTITUTE OF TECHNOLOGY & ENGINEERING  
HYDRABAD, TELANGANA





**DEPARTMENT OF MECHANICAL ENGINEERING**

**List of students enrolled in CATIA (2016-2017)**

|    |            |                                   |   |   |   |   |   |   |   |   |   |   |
|----|------------|-----------------------------------|---|---|---|---|---|---|---|---|---|---|
| 62 | 14E31A03A2 | SHEOB AHMED                       | P | P | P | P | P | P | P | P | P | P |
| 63 | 14E31A03A3 | SYED MD AHMED<br>MOHIUDDIN QUADRI | P | P | P | P | P | P | P | P | P | P |
| 64 | 13E31A0380 | MOHD FARHAN UDDIN                 | P | P | P | P | P | P | P | P | P | P |
| 65 | 15E35A0302 | HAKHILESH                         | P | P | P | P | P | P | P | P | P | P |
| 66 | 15E35A0303 | HEEREKAR RAHUL                    | P | P | P | P | P | P | P | P | P | P |
| 67 | 15E35A0304 | MAMIDIGA NAGI SHI                 | P | P | P | P | P | P | P | P | P | P |
| 68 | 15E35A0305 | MD SHOEB AKRAM                    | P | P | P | P | P | P | P | P | P | P |
| 69 | 15E35A0307 | MIYAKALA SHIVAKUMAR               | P | P | P | P | P | P | P | P | P | P |
| 70 | 15E35A0308 | SYED ASHFAQ                       | P | P | P | P | P | P | P | P | P | P |
| 71 | 13E31A0318 | C VENKATESH                       | P | P | P | P | P | P | P | P | P | P |

## About the College

As an Institute committed in quality education, MIST aims at providing learning with a Technology-edge. It endeavors to provide consistent training to its students to help them evolve as competent professionals in the highly competitive world. Right from its inception in 2001, it has been tuning itself to meet this objective. A new civilization is emerging in our lives. This civilization brings with it a new way of working. Millions are already tuning their lives to the rhythms of tomorrow.

## About Mechanical Dept.

The Mechanical engineering is one of the core engineering departments, which has potential to accommodate all efficient engineers. The Mechanical engineers serve all other branches of engineering directly or indirectly. The Mechanical engineers can find their place in Automobile engineering sector, Steel Plants, Power plants, Software industries, Manufacturing industries, Design industries, Military, Naval and Air force, Defense research organizations, Material research organizations etc.

## About the Workshop

The course builds from the big ideas in finite element analysis and computational fluid dynamics to ANSYS case studies that progress from real world applications and examples. ANSYS is the flagship engineering software solution that uses finite element analysis (FEA), which is a numerical and computational method used to solve the real engineering problems related to physics, structural analysis, heat transfer, fluid flow, mass transport, and electromagnetic potential field. To solve the problem, it subdivides a large problem into smaller, simpler parts that are called finite elements and solve the problem by minimizing an associated error function.

## Organising committee

### CHIEF PATRON

**Sri.S.Sudershan Reddy**  
Chairman

**Sri. S. Surendar Reddy**  
Secretary

**Sri S. Dhanunjay Reddy**  
Joint Secretary

### DIRECTOR

**Dr. H. S. N. Murthy**

### PATRON

**Dr.S.S.S.N.Reddy,Principal**

### CONVENER

**G.K.Shanmukh Dev,**  
**ASSO.Prof,Dept. Of Mechanical**

### PROGRAM COORDINATORS

**G.Siva Giridhar Yadav**

Conducted On

**02/05/2016- 13/05/2016**



# MAHAVEER

## INSTITUTE OF SCIENCE & TECHNOLOGY

Approved by AICTE, Affiliated to JNTU, Hyderabad.

Vyasapuri, Bandlaguda, Post: Keshavnagar, Hyderabad-500005.

# ANSYS®

**Two week  
Certification Course  
on**

# ANSYS

*Organized by*

*Department of Mechanical  
Engineering*

Vysapuri, Bandlaguda Post: Keshavgiri,  
Hyderabad-500 005, Telangana INDIA  
Tel: 040-84596979, 20020773, Fax: 040-24455093  
E-mail: [principal.mahaveer@gmail.com](mailto:principal.mahaveer@gmail.com)  
Website: [www.mist.ac.in](http://www.mist.ac.in)

**MAHAVEER**

INSTITUTE  
Approved by AICTE. Affiliated to JNTUH, Hyd



Date: 30-04-2016

To  
The Principal  
MIST,  
Hyderabad.

Sub: Proposal for Add-on Course-Reg.

Respected sir,

We are going to conduct 10 days Technical Training for IV B. Tech students on "Introduction to ANSYS". We require your approval to go head for proceeding and hope to get on opportunity to serve you the best.

With thanks and regards

*Kishor*  
PRINCIPAL  
MAHAVEER  
INSTITUTE OF LITERATURE & TECHNOLOGY  
BANDLAGUDA POST, KESHAVGIRI, HYDRABAD-500 005.

*G.K. Shanmukh Dev*  
G.K.SHANMUKH DEV

HOD

Department of Mechanical Engineering





Date: 01.05.2016

## CIRCULAR

Technical Training for IV B. Tech students are starting from 2<sup>nd</sup> MAY, 2016 onwards. All HODs and Placements coordinators have to manage the trainings and ensure 95% attendance all through the sessions.

All Mentors need to send the compiled feedback report to G.K.Shanmukh Dev, HOD at [e3hod.mech@gmail.com](mailto:e3hod.mech@gmail.com) daily.

Agenda: 1. Introduction to ANSYS.

**Design and Development of curriculum for Add on course:**

Name of the Faculty : G.Siva Giridhar Yadav

  
PRINCIPAL  
MAHAVEER  
INSTITUTE OF SCIENCE & TECHNOLOGY  
BANDLAGUDA, HYDRABAD-500 805.

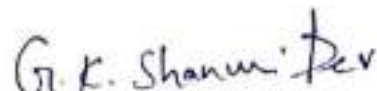
  
G.K.SHANMUKH DEV

HOD

Department of Mechanical Engineering

Vysapuri, Bandlaguda Post, Keshavnagar,  
Hyderabad-500 005, Telangana INDIA  
Tel: 040-64596979, 20020773, Fax: 040-24455003  
E-mail: [principal.mahaveer@gmail.com](mailto:principal.mahaveer@gmail.com),  
Website: [www.mist.ac.in](http://www.mist.ac.in).

# MAHAVEER



Approved by AICTE. Affiliated to JNTUH Hyd

## ANSYS SYLLABUS

| S.NO | TOPIC COVERED  | DURATION (Hours) |
|------|--|------------------|
| 1    | INTRODUCTION TO FEA AND                              | 3                |
| 2    | BASIC SOLID MODELING                                 | 3                |
| 3    | ADVANCED SOLID MODELING                              | 3                |
| 4    | FINITE ELEMENT MODELING (FEM) - I                    | 3                |
| 5    | FINITE ELEMENT MODELING (FEM) - II                   | 3                |
| 6    | SOLUTION AND POSTPROCESSOR                           | 3                |
| 7    | STATIC STRUCTURAL ANALYSIS                           | 3                |
| 8    | ADVANCED STRUCTURAL ANALYSIS (DYNAMIC AND NONLINEAR) | 3                |
| 9    | ADVANCED STRUCTURAL ANALYSIS                         | 2                |
| 10   | THERMAL ANALYSIS                                     | 2                |
| 11   | GENERATING THE REPORT OF ANALYSIS                    | 2                |

*Kishore*

PRINCIPAL  
MAHAVEER  
INSTITUTE OF TECHNOLOGY  
BANDLAGUDA POST, VYSAPURI, HYD-500005.



## Department of Mechanical Engineering ANSYS Technical Training student attendance list 2016-2017

| S.NO. | ROLL NO.   | NAME OF THE STUDENT                  | YEAR |
|-------|------------|--------------------------------------|------|
| 1     | 13E31A0302 | AENUGU MAHESH                        | IV   |
| 2     | 13E31A0303 | AERAGONI MAHESH                      | IV   |
| 3     | 13E31A0305 | ALI HASAN BAMASDOOS                  | IV   |
| 4     | 13E31A0306 | AMGOTH SUNILKUMAR                    | IV   |
| 5     | 13E31A0307 | ANTHATI JASHWANTH GOUD               | IV   |
| 6     | 13E31A0308 | ANTHATI PRAVEEN                      | IV   |
| 7     | 13E31A0309 | AVARI SAICHAND                       | IV   |
| 8     | 13E31A0310 | AVUCHARLA RAKESH                     | IV   |
| 9     | 13E31A0311 | AVULA GOPI                           | IV   |
| 10    | 13E31A0312 | AVULA LOHIT                          | IV   |
| 11    | 13E31A0314 | BANALA SANDEEP                       | IV   |
| 12    | 13E31A0315 | BANDI MURALIDHAR                     | IV   |
| 13    | 13E31A0316 | BOLISHETTI VAMSHI KRUSHNA            | IV   |
| 14    | 13E31A0317 | BOMMARAJU SAI MANOJ KUMAR            | IV   |
| 15    | 13E31A0319 | CHAGANTI VENKATESH                   | IV   |
| 16    | 13E31A0320 | CHAPIDI KRISHNAKANTH                 | IV   |
| 17    | 13E31A0322 | CHINTA BENU MADHAV                   | IV   |
| 18    | 13E31A0323 | BOROLE AKASH                         | IV   |
| 19    | 13E31A0324 | DEVARKONDA BALAJI                    | IV   |
| 20    | 13E31A0325 | GUDAVALLI SREEDHAR                   | IV   |
| 21    | 13E31A0326 | GUMMADAVELLI DURGA VENKATA RAMA TEJA | IV   |
| 22    | 13E31A0327 | JANGILI NAVEEN                       | IV   |

*K. S. S. S.*  
PRINCIPAL  
MAHAVEER  
INSTITUTE OF SCIENCE & TECHNOLOGY  
Bandlaguda, Hyderabad-500005.



Vysapuri, Bandlaguda Post, Keshavnagar,  
Hyderabad 500 005, Telangana INDIA  
Tel: 040-64596079, 20020773, Fax: 040-24455003  
E-mail: principal.mahaveer@gmail.com,  
Website: www.mist.ac.in,

# MAHAVEER



Approved by AICTE Affiliated to JNTU, Hyd

|    |            |                                  |    |
|----|------------|----------------------------------|----|
| 23 | 13E31A0328 | JUBREVAR AKSHAY                  | IV |
| 24 | 13E31A0329 | K J V CHAITANYA KUMAR            | IV |
| 25 | 13E31A0330 | K. PAVAN KUMAR                   | IV |
| 26 | 13E31A0331 | KADAVAKOLLU BHAVANI SANKAR       | IV |
| 27 | 13E31A0332 | KARNI VEERENDRA                  | IV |
| 28 | 13E31A0333 | KATTA KRANTHI KUMAR              | IV |
| 29 | 13E31A0337 | MALOTHUJ SURENDER NAYAK          | IV |
| 30 | 13E31A0338 | MD IRFAN                         | IV |
| 31 | 13E31A0339 | MOHAMMED AHMED MOHIUDDIN         | IV |
| 32 | 13E31A0340 | MOHAMMED SHOIB ALI               | IV |
| 33 | 13E31A0341 | MONGALA ABHINAV                  | IV |
| 34 | 13E31A0342 | MUSHKAM SHEKHAR                  | IV |
| 35 | 13E31A0343 | PARVATHA VINAY KUMAR             | IV |
| 36 | 13E31A0344 | PEDDINTY RANJITH KUMAR           | IV |
| 37 | 13E31A0345 | PERURI VIJAY KUMAR               | IV |
| 38 | 13E31A0346 | PORANDLA SHARATHCHANDRA          | IV |
| 39 | 13E31A0347 | R KAMAL                          | IV |
| 40 | 13E31A0348 | RAMELLI VAMSIHIDHER              | IV |
| 41 | 13E31A0349 | RAPARTHI ANIL KUMAR              | IV |
| 42 | 13E31A0351 | S.MUKESH KUMAR                   | IV |
| 43 | 13E31A0352 | SAMDELA MANEESH                  | IV |
| 44 | 13E31A0353 | SATLA SRIKAR RAJ                 | IV |
| 45 | 13E31A0354 | SHAH MAHAMMED RIZWAN TABARUK ALI | IV |
| 46 | 13E31A0356 | SUNKI SRINIVAS                   | IV |
| 47 | 13E31A0357 | SWAMY SACHIDANAND                | IV |
| 48 | 13E31A0358 | THATI KRISHNA RAO                | IV |

*K. V. S.*  
PRINCIPAL  
MAHAVEER  
INSTITUTE OF TECHNOLOGY  
BANDLAGUDA, HYD-500 005.

Vysapuri, Bandlaguda Post Keshavnagar,  
Hyderabad 500 005, Telangana INDIA  
Tel: 040-64536379, 20020773, Fax: 040-24455603  
E-mail: principal.mahaveer@gmail.com,  
Website: www.nust.ac.in

# MAHAVEER



Approved by AICTE Affiliated to JNTU, Hydr

|    |            |                                      |    |
|----|------------|--------------------------------------|----|
| 49 | 13E31A0359 | THATIKANTH ANIL                      | IV |
| 50 | 13E31A0360 | VIKAS KUMAR                          | IV |
| 51 | 13E31A0361 | D SAI AKASHI                         | IV |
| 52 | 13E31A0362 | DAMERA RANJITH                       | IV |
| 53 | 13E31A0363 | DEGA MADHUKAR                        | IV |
| 54 | 13E31A0364 | DHARAVATH ROOP SINGH                 | IV |
| 55 | 13E31A0365 | ERRI KAMALAKAR                       | IV |
| 56 | 13E31A0366 | G VENKATESH                          | IV |
| 57 | 13E31A0367 | GONALOLU PRADEEP KUMAR               | IV |
| 58 | 13E31A0368 | GUDELLI VIJAYKUMAR                   | IV |
| 59 | 13E31A0369 | J.SHIVA RAJ                          | IV |
| 60 | 13E31A0370 | JADDU EKAMBARA SRINIVASA PHANI KUMAR | IV |
| 61 | 13E31A0371 | JALINGAM HEMANTH KUMAR               | IV |
| 62 | 13E31A0372 | K BIHARATHSIMHA REDDY                | IV |
| 63 | 13E31A0373 | K PRAVEEN                            | IV |
| 64 | 13E31A0375 | K SANDEEP REDDY                      | IV |
| 65 | 13E31A0376 | K SHIVAJI                            | IV |
| 66 | 13E31A0377 | KADANACHI ADARSH KUMAR               | IV |
| 67 | 13E31A0379 | M RAMU                               | IV |
| 68 | 13E31A0381 | MOHITH S.R. MANE                     | IV |
| 69 | 13E31A0382 | MOLLA NOOR BASHA                     | IV |
| 70 | 13E31A0383 | P.PRADEEP NAIK                       | IV |
| 71 | 13E31A0384 | PANDEY PRINCE CHINTAMANI             | IV |
| 72 | 13E31A0385 | RETINENI BALARAM                     | IV |
| 73 | 13E31A0387 | SYED MUFAQUAM ALI                    | IV |
| 74 | 13E31A0388 | SYED ZIAUDDIN                        | IV |

*K. Srinivas*  
PRINCIPAL  
MAHAVEER  
KESHAVNAGAR, BANDLAGUDA POST  
HYDERABAD, PIN-500 005

Vysapuri, Bandlaguda Post Keshavnagar,  
Hyderabad 500 005, Telangana INDIA  
Tel: 040-64596979, 20020775, Fax: 040-24455093  
E-mail: [principal.mahaveer@gmail.com](mailto:principal.mahaveer@gmail.com),  
Website: [www.mist.ac.in](http://www.mist.ac.in),

# MAHAVEER



Approved by AICTE, Affiliated to JNTU Hyd

|    |            |                           |    |
|----|------------|---------------------------|----|
| 75 | 13E31A0389 | I.DIVYA TEJA              | IV |
| 76 | 13E31A0390 | T.VINEETHI                | IV |
| 77 | 13E31A0391 | THADAKAPPELLI PRAVEEN     | IV |
| 78 | 13E31A0392 | THATIKONDA SREEKAR        | IV |
| 79 | 13E31A0393 | THOTA RAMESH              | IV |
| 80 | 13E31A0394 | TIPPANI ASHRITH PRASHANTH | IV |
| 81 | 13E31A0395 | VADICHARLA RAMESH         | IV |
| 82 | 13E31A0396 | Y LALITH KUMAR            | IV |
| 83 | 13E31A0398 | GANGULA SRINIVAS          | IV |
| 84 | 13E31A0399 | DASARI RAJU PRANEETH      | IV |
| 85 | 13E31A03A0 | MANNEM JASVANTH           | IV |
| 86 | 13E31A03A1 | SODI ARJUN                | IV |
| 87 | 13E31A03A2 | MUDAVATH NARESH           | IV |
| 88 | 14E35A0303 | SONU GUPTA                | IV |

*K. Srinivas*  
PRINCIPAL  
MAHAVEER  
INSTITUTE OF SCIENCE & TECHNOLOGY  
Bandlaguda, Hyderabad-500 005.





## Technical Training Exam on ANSYS Software (A.Y-2016-2017)

2x10=20 Marks

### Answer All the Questions

1. Given the 2D truss structure represented in Figure 1.1, where:
- $h = 5 \text{ m}$
  - $L = 5 \text{ m}$
  - $P = 1000 \text{ N}$
  - $E = 1.0 \times 10^7 \text{ N/m}^2$  (Young's modulus)
  - $A = 0.1 \text{ m}^2$  (Cross-section area of each beam element)

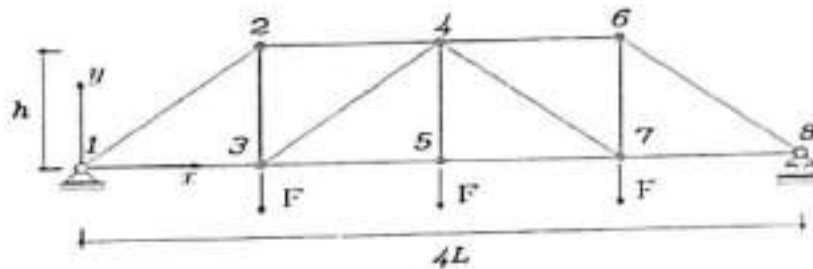

Figure 1.1: Example truss structure, constraints and loads.

2. 7.13 Determine the stresses in the plate with the hole subjected to the tensile stress shown in Figure P7-13. Graph the stress variation  $\sigma_x$  versus the distance  $y$  from the hole. Let  $E = 200 \text{ GPa}$ ,  $\nu = 0.25$ , and  $r = 25 \text{ mm}$ . (Use various mesh densities, depending on your computer program in your finite element model.) Use symmetry as appropriate.



Figure P7-13

*Mahaveer*

**PRINCIPAL**  
**M. MAHAVEER**  
MIMTE - VISITING PROFESSOR  
Bandlaguda, Hyd-500 005.



**Department of Mechanical Engineering**  
**ANSYS Technical Training student attendance list 2016-2017**

| S.NO | Roll No    | Name of the student                     | YEAR | MARKS | PASS/FAIL |
|------|------------|---|------|-------|-----------|
| 1    | 13E31A0302 | AENUGU MAHESH                           | IV   | 15    | PASS      |
| 2    | 13E31A0303 | AERAGONI MAHESH                         | IV   | 16    | PASS      |
| 3    | 13E31A0305 | ALIHASAN BAMASDOOS                      | IV   | 18    | PASS      |
| 4    | 13E31A0306 | AMGOTHI SUNILKUMAR                      | IV   | 15    | PASS      |
| 5    | 13E31A0307 | ANTHATI JASHWANTH GOUD                  | IV   | 15    | PASS      |
| 6    | 13E31A0308 | ANTHATI PRAVEEN                         | IV   | 15    | PASS      |
| 7    | 13E31A0309 | AVARI SAICHAND                          | IV   | 16    | PASS      |
| 8    | 13E31A0310 | AVUCHARLA RAKESH                        | IV   | 15    | PASS      |
| 9    | 13E31A0311 | AVULA GOPI                              | IV   | 16    | PASS      |
| 10   | 13E31A0312 | AVULA LOHIT                             | IV   | 12    | PASS      |
| 11   | 13E31A0314 | BANALA SANDEEP                          | IV   | 15    | PASS      |
| 12   | 13E31A0315 | BANDI MURALIDHAR                        | IV   | 16    | PASS      |
| 13   | 13E31A0316 | BOLISHETTI VAMSHI KRUSHNA               | IV   | 12    | PASS      |
| 14   | 13E31A0317 | BOMMARAJU SAI MANOJ KUMAR               | IV   | 15    | PASS      |
| 15   | 13E31A0319 | CHAGANTI VENKATESH                      | IV   | 16    | PASS      |
| 16   | 13E31A0320 | CHAPIDI KRISHNAKANTHI                   | IV   | 14    | PASS      |
| 17   | 13E31A0322 | CHINTA BENU MADHAV                      | IV   | 15    | PASS      |
| 18   | 13E31A0323 | BOROLE AKASH                            | IV   | 17    | PASS      |
| 19   | 13E31A0324 | DEVARKONDA BALAJI                       | IV   | 15    | PASS      |
| 20   | 13E31A0325 | GUDAVALLI SREEDHAR                      | IV   | 16    | PASS      |
| 21   | 13E31A0326 | GUMMADAVELLI DURGA<br>VENKATA RAMA TEJA | IV   | 16    | PASS      |
| 22   | 13E31A0327 | JANGILI NAVEEN                          | IV   | 15    | PASS      |
| 23   | 13E31A0328 | JUBREVAR AKSHAY                         | IV   | 16    | PASS      |

*K. K. K.*  
PRINCIPAL  
MAHAVEER  
INSTITUTE OF SCIENCE & TECHNOLOGY  
Vysapalem, Hyderabad-502 025.

Vysapuri, Brahmaguda Post Keshavnagar  
Hyderabad 500 055, Telangana INDIA  
Tel: 040-64596379 21026773, Fax: 040-24455003  
E-mail: principal.mahaveer@gmail.com  
Website: www.mst.ac.in

# MAHAVEER



Approved by AICTE. Affiliated to JNTU Hyd

|    |            |                                  |    |    |      |
|----|------------|----------------------------------|----|----|------|
| 24 | 13E31A0329 | K J V CHAITANYA KUMAR            | IV | 14 | PASS |
| 25 | 13E31A0330 | K. PAVAN KUMAR                   | IV | 15 | PASS |
| 26 | 13E31A0331 | KADAVAKOLLU BHAVANI SANKAR       | IV | 15 | PASS |
| 27 | 13E31A0332 | KARNI VEERENDRA                  | IV | 16 | PASS |
| 28 | 13E31A0333 | KATTA KRANTHI KUMAR              | IV | 14 | PASS |
| 29 | 13E31A0337 | MALOTHU SURENDER NAYAK           | IV | 15 | PASS |
| 30 | 13E31A0338 | MD IRFAN                         | IV | 15 | PASS |
| 31 | 13E31A0339 | MOHAMMED AHMED MOHIUDDIN         | IV | 14 | PASS |
| 32 | 13E31A0340 | MOHAMMED SHOIB ALI               | IV | 16 | PASS |
| 33 | 13E31A0341 | MONGALA ABHINAV                  | IV | 16 | PASS |
| 34 | 13E31A0342 | MUSHKAM SHEKHAR                  | IV | 14 | PASS |
| 35 | 13E31A0343 | PARVATHA VINAY KUMAR             | IV | 15 | PASS |
| 36 | 13E31A0344 | PEDDINTY RANJITH KUMAR           | IV | 16 | PASS |
| 37 | 13E31A0345 | PERURI VIJAY KUMAR               | IV | 15 | PASS |
| 38 | 13E31A0346 | PORANDLA SHARATHCHANDRA          | IV | 16 | PASS |
| 39 | 13E31A0347 | R KAMAL                          | IV | 14 | PASS |
| 40 | 13E31A0348 | RAMEE LI VAMSHIDHAR              | IV | 12 | PASS |
| 41 | 13E31A0349 | RAPARTHI ANIL KUMAR              | IV | 15 | PASS |
| 42 | 13E31A0351 | S.MUKESH KUMAR                   | IV | 16 | PASS |
| 43 | 13E31A0352 | SANDELA MANEESH                  | IV | 15 | PASS |
| 44 | 13E31A0353 | SATLA SRIKAR RAJ                 | IV | 16 | PASS |
| 45 | 13E31A0354 | SHAH MAHAMMED RIZWAN TABARUK ALI | IV | 15 | PASS |
| 46 | 13E31A0356 | SUNKI SRINIVAS                   | IV | 14 | PASS |
| 47 | 13E31A0357 | SWAMY SACHIDANAND                | IV | 18 | PASS |

*K. Srinivas*

PRINCIPAL  
MAHAVEER  
INSTITUTE OF SCIENCE & TECHNOLOGY  
KESHAVNAGAR



Vysyaleti Bandlaguda Post Keshavnagar,  
Hyderabad 500 005, Telangana INDIA  
Tel: 040-94054279, 20020773, Fax: 040-24450093  
E-mail: [prince.mahaveer@gmail.com](mailto:prince.mahaveer@gmail.com)  
Website: [www.mahaveer.ac.in](http://www.mahaveer.ac.in)

# MAHAVEER



Approved by AICTE Affiliated to JNTU, Hyd

|    |            |                                      |    |    |      |
|----|------------|--------------------------------------|----|----|------|
| 48 | 13E31A0358 | HATH KRISHNA RAO                     | IV | 15 | PASS |
| 49 | 13E31A0359 | HATHKANTH ANIL                       | IV | 16 | PASS |
| 50 | 13E31A0360 | VIKAS KUMAR                          | IV | 15 | PASS |
| 51 | 13E31A0361 | D SAI AKASH                          | IV | 16 | PASS |
| 52 | 13E31A0362 | DAMERA RANJITH                       | IV | 15 | PASS |
| 53 | 13E31A0363 | DEGA MADHUKAR                        | IV | 16 | PASS |
| 54 | 13E31A0364 | DHARAVATH ROOP SINGH                 | IV | 14 | PASS |
| 55 | 13E31A0365 | ERRI KAMALAKAR                       | IV | 12 | PASS |
| 56 | 13E31A0366 | G VENKATESH                          | IV | 15 | PASS |
| 57 | 13E31A0367 | GONALOLU PRADEEP KUMAR               | IV | 16 | PASS |
| 58 | 13E31A0368 | GUDELLI VIJAYKUMAR                   | IV | 15 | PASS |
| 59 | 13E31A0369 | J.SHIVA RAJ                          | IV | 16 | PASS |
| 60 | 13E31A0370 | JADDU EKAMBARA SRINIVASA PHANI KUMAR | IV | 15 | PASS |
| 61 | 13E31A0371 | JALINGAM HEMANTH KUMAR               | IV | 14 | PASS |
| 62 | 13E31A0372 | K BHARATHSIMHA REDDY                 | IV | 18 | PASS |
| 63 | 13E31A0373 | K PRAVEEN                            | IV | 15 | PASS |
| 64 | 13E31A0375 | K SANDEEP REDDY                      | IV | 16 | PASS |
| 65 | 13E31A0376 | K SUIVAJI                            | IV | 15 | PASS |
| 66 | 13E31A0377 | KADANACHI ADARSH KUMAR               | IV | 15 | PASS |
| 67 | 13E31A0379 | M RAMU                               | IV | 16 | PASS |
| 68 | 13E31A0381 | MOHITH S.R. MANE                     | IV | 18 | PASS |
| 69 | 13E31A0382 | MOLLA NOOR BASHA                     | IV | 17 | PASS |
| 70 | 13E31A0383 | P.PRADEEP NAIK                       | IV | 16 | PASS |
| 71 | 13E31A0384 | PANDEY PRINCE CHINTAMANI             | IV | 15 | PASS |
| 72 | 13E31A0385 | RETINENI BALARAM                     | IV | 16 | PASS |

*Handwritten Signature*  
PRINCIPAL  
MAHAVEER  
M.A.T. OF SCIENCE & TECH.  
BANDLAGUDA, HYD-500 005.

Vysapuri, Bandlaguda Post, Keshavnagar,  
Hyderabad 500 025, Telangana 500 025  
Tel: 040-64599379, 20020773, Fax: 040-24455003  
E-mail: [pravin.gupta@mahaveer.com](mailto:pravin.gupta@mahaveer.com)  
Website: [www.mist.ac.in](http://www.mist.ac.in)

# MAHAVEER



Approved by AICTE, Attached to JNTU(Hy)

|    |            |                           |    |    |      |
|----|------------|---------------------------|----|----|------|
| 73 | 13E31A0387 | SYED MUIAQUAM ALI         | IV | 18 | PASS |
| 74 | 13E31A0388 | SYED ZIAUDDIN             | IV | 15 | PASS |
| 75 | 13E31A0389 | T.DIVYA TEJA              | IV | 15 | PASS |
| 76 | 13E31A0390 | T.VINEETH                 | IV | 15 | PASS |
| 77 | 13E31A0391 | THADAKAPELLI PRAVEEN      | IV | 16 | PASS |
| 78 | 13E31A0392 | THATIKONDA SREEKAR        | IV | 15 | PASS |
| 79 | 13E31A0393 | THOTA RAMESH              | IV | 16 | PASS |
| 80 | 13E31A0394 | TIPPANI ASHRITH PRASHANTH | IV | 12 | PASS |
| 81 | 13E31A0395 | VADICHARLA RAMESH         | IV | 15 | PASS |
| 82 | 13E31A0396 | Y LALITH KUMAR            | IV | 16 | PASS |
| 83 | 13E31A0398 | GANGULA SRINIVAS          | IV | 12 | PASS |
| 84 | 13E31A0399 | DASARI RAJU PRANEETH      | IV | 15 | PASS |
| 85 | 13E31A03A0 | MANNEM JASVANTH           | IV | 16 | PASS |
| 86 | 13E31A03A1 | SODI ARJUN                | IV | 14 | PASS |
| 87 | 13E31A03A2 | MUDAVATH NARESH           | IV | 15 | PASS |
| 88 | 14E35A0303 | SONU GUPTA                | IV | 17 | PASS |

*K. Srinivas*

M.I  
INSTITUTE  
BANDLAGUDA



## ANSYS COURSE Summary

### Department of Mechanical Engineering

1. The Geometry preparation training course is for users who want to create and modify geometry in preparation for CFD or FEA analysis. The training will be focused in either ANSYS Design Modeler or ANSYS Space Claim.
2. The ANSYS Meshing training course will give you the tools for generating good quality meshes for Fluent and CFX. The trainee will choose which tool should be used: ANSYS Meshing, Fluent Meshing or ICEM CFD.
3. This course will show how to set up a range of simulation types in the ANSYS Fluent or ANSYS CFX solver, as well as how to post process the results by using our CFD Post Tool.
4. This course will show how to set up a range of simulation types in ANSYS Mechanical, as well as how to post process and evaluate your results.
5. To acquire advance knowledge to perform explicit simulations with ANSYS Explicit STR, ANSYS AUTODYN or ANSYS LS-DYNA.
6. This is an introductory to intermediate level training for using ANSYS HFSS for all applications, like RF/microwave, antennas or planar problems. Participants will get understanding of HFSS modeling, solution process and post-processing features, which can be used for other advanced applications. The course will also cover advanced topics like dynamic link between EM and circuit, impedance matching, overview of HFSS 3D layout interface and speeding-up HFSS simulation using HPC.
7. Provide the needed tools for the complete simulation of a pressure Vessel from scratch. Several types of analysis and boundary conditions will be discussed, by using pressure vessels examples.
8. To acquire advance knowledge for performing mechanical simulation in Fixed Offshore Structures.

Copy to :

1. Department of Notice Board
2. Principal for Information
3. Committee Members (Academic)

*K. Mahaveer*  
PRINCIPAL  
MAHAVEER  
INSTITUTE OF ENGINEERING & TECHNOLOGY  
BANDLAGUDA, HYD-500 005.



Vysapuri, Bandlaguda Post Keshavnagar  
Hyderabad 500 081, Telangana INDIA  
Tel: 040-6409979, 20029713, Fax: 040 24485003  
E-mail: [principal.mahaveer@gmail.com](mailto:principal.mahaveer@gmail.com)  
Website: [www.mist.ac.in](http://www.mist.ac.in)

# MAHAVEER



Approved by AICTE. Affiliated to JNTUHH Hyd

## CERTIFICATE OF COURSE COMPLETION

This certificate is presented to D. Sai Akash of  
MIST, who has successfully completed technical training course on  
"ANSYS" held from 02-05-2016 to 13-05-2016 and found the  
student performance to be excellent.

*Kanish*  
Principal  
MAHAVEER  
INSTITUTE OF SCIENCE & TECHNOLOGY  
BANDLAGUDA POST, KESHAVNAGAR  
HYDERABAD - 500081



ESTD : 2001

*G.K. Shanmukh Dev*  
G.K. SHANMUKH DEV

HOD

Department of Mechanical Engineering



## DEPARTMENT OF MECHANICAL ENGINEERING

### List of students enrolled in ANSYS (2016-2017)

| S.No | Roll No    | Date                      | 2/5/16 | 3/5 | 4/5 | 5/5 | 6/5 | 7/5 | 10/5 | 11/5 | 12/5 | 13/5 |
|------|------------|---------------------------|--------|-----|-----|-----|-----|-----|------|------|------|------|
| 1    | 13E31A0302 | AENUGU MAHESH             | P      | P   | P   | P   | P   | P   | P    | P    | P    | P    |
| 2    | 13E31A0303 | AERAGONI MAHESH           | P      | P   | P   | P   | P   | P   | P    | P    | P    | P    |
| 3    | 13E31A0305 | ALI HASAN BAMSADOOS       | P      | P   | P   | P   | P   | P   | P    | P    | P    | P    |
| 4    | 13E31A0306 | AMGOTH SUNIL KUMAR        | P      | P   | P   | P   | P   | P   | P    | P    | P    | P    |
| 5    | 13E31A0307 | ANTHATI JASHWANTH GOUD    | P      | P   | P   | P   | P   | P   | P    | P    | P    | P    |
| 6    | 13E31A0308 | ANTHATI PRAVEEN           | P      | P   | P   | P   | P   | P   | P    | P    | P    | P    |
| 7    | 13E31A0309 | AVARI SAICHAND            | P      | P   | P   | P   | P   | P   | P    | P    | P    | P    |
| 8    | 13E31A0310 | AVUCHARLA RAKESH          | P      | P   | P   | P   | P   | P   | P    | P    | P    | P    |
| 9    | 13E31A0311 | AVULA GOPI                | P      | P   | P   | P   | P   | P   | P    | P    | P    | P    |
| 10   | 13E31A0312 | AVULA LOHIT               | P      | P   | P   | P   | P   | P   | P    | P    | P    | P    |
| 11   | 13E31A0314 | BANALA SANDEEP            | P      | P   | P   | P   | P   | P   | P    | P    | P    | P    |
| 12   | 13E31A0315 | BANDI MURALIDHAR          | P      | P   | P   | P   | P   | P   | P    | P    | P    | P    |
| 13   | 13E31A0316 | BOLISHETTI VAMSHI KRUSHNA | P      | P   | P   | P   | P   | P   | P    | P    | P    | P    |
| 14   | 13E31A0317 | BOMMARAJU SAUMANJ KUMAR   | P      | P   | P   | P   | P   | P   | P    | P    | P    | P    |
| 15   | 13E31A0319 | CHAGANTI VENKATESH        | P      | P   | P   | P   | P   | P   | P    | P    | P    | P    |
| 16   | 13E31A0320 | CHAPIDI KRISHNA ANTH      | P      | P   | P   | P   | P   | P   | P    | P    | P    | P    |
| 17   | 13E31A0322 | CHINTA BENU MADHAV        | P      | P   | P   | P   | P   | P   | P    | P    | P    | P    |

**Kishu**  
WEEK  
11/11/2017  
11/11/2017



## DEPARTMENT OF MECHANICAL ENGINEERING

### List of students enrolled in ANSYS (2016-2017)

|    |            |   |   |   |   |   |   |   |   |   |   |   |   |
|----|------------|---|---|---|---|---|---|---|---|---|---|---|---|
| 18 | 13E31A0323 | BOROLE AKASH                            | P | P | P | P | P | P | P | P | P | P | P |
| 19 | 13E31A0324 | DEVARKONDA BALAJI                       | P | P | P | P | P | P | P | P | P | P | P |
| 20 | 13E31A0325 | GUDAVALLI SREEDHAR                      | P | P | P | P | P | P | P | P | P | P | P |
| 21 | 13E31A0326 | GUMMADEVELLI DURGA<br>VENKATA RAMA TEJA | P | P | P | P | P | P | P | P | P | P | P |
| 22 | 13E31A0327 | JANGILI NAVEEN                          | P | P | P | P | P | P | P | P | P | P | P |
| 23 | 13E31A0328 | JUBREVAR AKSHAY                         | P | P | P | P | P | P | P | P | P | P | P |
| 24 | 13E31A0329 | K J V CHAITANYA KUMAR                   | P | P | P | P | P | P | P | P | P | P | P |
| 25 | 13E31A0330 | K. PAVAN KUMAR                          | P | P | P | P | P | P | P | P | P | P | P |
| 26 | 13E31A0331 | K BHAVANI SANKAR                        | P | P | P | P | P | P | P | P | P | P | P |
| 27 | 13E31A0332 | KARNI VEERENDRA                         | P | P | P | P | P | P | P | P | P | P | P |
| 28 | 13E31A0333 | KATTA KRANTHI KUMAR                     | P | P | P | P | P | P | P | P | P | P | P |
| 29 | 13E31A0337 | MALOTHU SURENDER<br>NAYAK               | P | P | P | P | P | P | P | P | P | P | P |
| 30 | 13E31A0338 | MD IRFAN                                | P | P | P | P | P | P | P | P | P | P | P |
| 31 | 13E31A0339 | MOHAMMED AHMED<br>MOHIUDDIN             | P | P | P | P | P | P | P | P | P | P | P |
| 32 | 13E31A0340 | MOHAMMED SHOBALI                        | P | P | P | P | P | P | P | P | P | P | P |
| 33 | 13E31A0341 | MONGALA ABHINAV                         | P | P | P | P | P | P | P | P | P | P | P |
| 34 | 13E31A0342 | MUSHKAM SHEKHAR                         | P | P | P | P | P | P | P | P | P | P | P |
| 35 | 13E31A0343 | PARVATHA VINAY KUMAR                    | P | P | P | P | P | P | P | P | P | P | P |
| 36 | 13E31A0344 | PEDDINTY RANJITH KUMAR                  | P | P | P | P | P | P | P | P | P | P | P |

*Handwritten signature*  
 DEER  
 12/11/2017, 00:01  
 ... 500 DUS





## DEPARTMENT OF MECHANICAL ENGINEERING

### List of students enrolled in ANSYS (2016-2017)

|    |            |                                     |   |   |   |   |   |   |   |   |   |   |
|----|------------|-------------------------------------|---|---|---|---|---|---|---|---|---|---|
| 37 | 13E31A0345 | PERURI VIJAY KUMAR                  | P | P | P | P | P | P | P | P | P | P |
| 38 | 13E31A0346 | P SHARATHICHANDRA                   | P | P | P | P | P | P | P | P | P | P |
| 39 | 13E31A0347 | R KAMAL                             | P | P | P | P | P | P | P | P | P | P |
| 40 | 13E31A0348 | RAMELLI VAMSHIDHAR                  | P | P | P | P | P | P | P | P | P | P |
| 41 | 13E31A0349 | RAPARTHI ANIL KUMAR                 | P | P | P | P | P | P | P | P | P | P |
| 42 | 13E31A0351 | S.MUKESH KUMAR                      | P | P | P | P | P | P | P | P | P | P |
| 43 | 13E31A0352 | SAMDELA MANEESH                     | P | P | P | P | P | P | P | P | P | P |
| 44 | 13E31A0353 | SATLA SRIKAR RAJ                    | P | P | P | P | P | P | P | P | P | P |
| 45 | 13E31A0354 | SHAH MAHAMMED RIZWAN<br>TABARUK ALI | P | P | P | P | P | P | P | P | P | P |
| 46 | 13E31A0356 | SUNKI SRINIVAS                      | P | P | P | P | P | P | P | P | P | P |
| 47 | 13E31A0357 | SWAMY SACHIDANAND                   | P | P | P | P | P | P | P | P | P | P |
| 48 | 13E31A0358 | THATI KRISHNA RAO                   | P | P | P | P | P | P | P | P | P | P |
| 49 | 13E31A0359 | THATIKANTH ANH                      | P | P | P | P | P | P | P | P | P | P |
| 50 | 13E31A0360 | VIKAS KUMAR                         | P | P | P | P | P | P | P | P | P | P |
| 51 | 13E31A0361 | D SAI AKASH                         | P | P | P | P | P | P | P | P | P | P |
| 52 | 13E31A0362 | DAMERA RANJITH                      | P | P | P | P | P | P | P | P | P | P |
| 53 | 13E31A0363 | DEGA MADHUKAR                       | P | P | P | P | P | P | P | P | P | P |
| 54 | 13E31A0364 | DHARAVATHI ROOP SINGH               | P | P | P | P | P | P | P | P | P | P |
| 55 | 13E31A0365 | ERRI KAMALAKAR                      | P | P | P | P | P | P | P | P | P | P |
| 56 | 13E31A0366 | G VENKATESH                         | P | P | P | P | P | P | P | P | P | P |

*K. Srinivas*  
MAHAVEER  
INSTITUTE OF SCIENCE AND TECHNOLOGY  
VYNAPURI, HYD-500 005.



## DEPARTMENT OF MECHANICAL ENGINEERING

### List of students enrolled in ANSYS (2016-2017)

|    |            |                                      |   |   |   |   |   |   |   |   |   |   |
|----|------------|--------------------------------------|---|---|---|---|---|---|---|---|---|---|
| 57 | 13E31A0367 | GONALOLU PRADEEP KUMAR               | P | P | P | P | P | P | P | P | P | P |
| 58 | 13E31A0368 | GUDELLI VIJAYKUMAR                   | P | P | P | P | P | P | P | P | P | P |
| 59 | 13E31A0369 | J.SHIVA RAJ                          | P | P | P | P | P | P | P | P | P | P |
| 60 | 13E31A0370 | JADDU EKAMBARA SRINIVASA PHANI KUMAR | P | P | P | P | P | P | P | P | P | P |
| 61 | 13E31A0371 | JALINGAM HEMANTH KUMAR               | P | P | P | P | P | P | P | P | P | P |
| 62 | 13E31A0372 | K BHARATHISIMHA REDDY                | P | P | P | P | P | P | P | P | P | P |
| 63 | 13E31A0373 | K PRAVEEN                            | P | P | P | P | P | P | P | P | P | P |
| 64 | 13E31A0375 | K SANDEEP REDDY                      | P | P | P | P | P | P | P | P | P | P |
| 65 | 13E31A0376 | K SHIVAJI                            | P | P | P | P | P | P | P | P | P | P |
| 66 | 13E31A0377 | KADANACHI ADARSH KUMAR               | P | P | P | P | P | P | P | P | P | P |
| 67 | 13E31A0379 | M RAMU                               | P | P | P | P | P | P | P | P | P | P |
| 68 | 13E31A0381 | MOHITH S.R. MANI                     | P | P | P | P | P | P | P | P | P | P |
| 69 | 13E31A0382 | MOLLA NOOR BASHA                     | P | P | P | P | P | P | P | P | P | P |
| 70 | 13E31A0383 | P.PRADEEP NAIK                       | P | P | P | P | P | P | P | P | P | P |
| 71 | 13E31A0384 | PANDEY PRINCE CHINTAMANI             | P | P | P | P | P | P | P | P | P | P |
| 72 | 13E31A0385 | RETINENI BALARAM                     | P | P | P | P | P | P | P | P | P | P |
| 73 | 13E31A0387 | SYED MUFAQUAM ALI                    | P | P | P | P | P | P | P | P | P | P |
| 74 | 13E31A0388 | SYED ZIAUDDIN                        | P | P | P | P | P | P | P | P | P | P |
| 75 | 13E31A0389 | T.DIVYA TEJA                         | P | P | P | P | P | P | P | P | P | P |







Vysapuri, Bandlaguda Post:Keshavgiri,

Hyderabad-500 005, TELANGANA INDIA  
Tel: 040-64596979,8978380692,Fax: 040-24455003  
E-mail: e3hod.it@gmail.com,  
Website: www.mist.ac.in,

# MAHAVEER

INSTITUTE OF SCIENCE & TECHNOLOGY

Approved by AICTE, Affiliated to JNTUH,Hyd.



DEPARTMENT OF ELECTRONICS AND COMMUNICATION ENGINEERING

Date: 01-08-2016

### CIRCULAR

Technical Trainings MS-Office for III B. Tech students are starting from **17-08-2016** onwards. All the students III year ,B.Tech I Semester should attend.

Design and development of curriculum for add-on courses :

Faculty Names: 1.Prof B.Visweswar Rao  
2.Mr. Obul Reddy  
3. Mr. G. Krishna Murthy

HOD, ECE

Cc: Principal for information  
: Coordinator to inform the students  
: Notice board & department File.



PRINCIPAL  
M. S. VEER  
INSTITUTE OF SCIENCE & TECHNOLOGY  
Bandlaguda, Hyd-500 005.

Vysapuri, Bandlaguda Post:Keshavgiri,

# MAHAVEER

INSTITUTE OF SCIENCE & TECHNOLOGY

Approved by AICTE, Affiliated to JNTUH,Hyd.



Hyderabad-500 005, TELANGANA INDIA

Tel: 040-64596979,8978380692,Fax: 040-24455003

E-mail: e3hod.it@gmail.com,

Website: www.mist.ac.in,

DEPARTMENT OF ELECTRONICS AND COMMUNICATION ENGINEERING

SYLLABUS FOR Technical Training MS-Office

| SNO | TOPIC COVERED  | DURATION |
|-----|--|----------|
| 1   | Ms. word : Creating, editing, saving and printing text documents ~ | 3        |
| 2   | Inserting tables, smart art, page breaks                           | 3        |
| 3   | Using lists and styles   | 3        |
| 4   | Working with images  | 3        |
| 5   | Using Spelling and Grammar check                                   | 3        |
| 6   | Mail Merge   | 3        |
| 7   | Ms. Excel: Spreadsheet basics                                      | 3        |
| 8   | Creating, editing, saving and printing spreadsheets                | 3        |
| 9   | Working with functions & formulas                                  | 3        |
| 10  | Graphically representing data : Charts & Graphs                    | 3        |
| 11  | Speeding data entry : Using Data Forms                             | 3        |
| 12  | Analyzing data : Data Menu, Subtotal, Filtering Data               | 3        |
| 13  | Ms. Power Point : Opening, viewing, creating, and printing slides  | 3        |
| 14  | Applying auto layouts  | 3        |
| 15  | Adding custom animation  | 3        |
| 16  | Using slide transitions  | 3        |
| 17  | Creating Professional Slide for Presentation.                      | 3        |

*K. S. S. S.*

PRINCIPAL  
MAHAVEER  
INSTITUTE OF SCIENCE & TECHNOLOGY  
Bandlaguda, Hyd-500 005.

Vysapuri, Bandlaguda Post:Keshavgi,

# MAHAVEER

INSTITUTE OF SCIENCE & TECHNOLOGY

Approved by AICTE, Affiliated to JNTUH,Hyd.



Hyderabad-500 005, TELANGANA INDIA

Tel: 040-64596979,8978380692 Fax: 040-24455003

E-mail: e3hod.it@gmail.com,

Website: www.mist.ac.in,

DEPARTMENT OF ELECTRONICS AND COMMUNICATION ENGINEERING

## LIST OF REGISTERED STUDENTS FOR Technical Training MS-Office

| S.No | Hall Ticket No | Name of the Candidate               |
|------|----------------|-------------------------------------|
| 1    | 15E31A0403     | AKULA SHUCHENDRA                    |
| 2    | 15E31A0404     | ALLA VENKATA KRISHNA VAMSHI         |
| 3    | 15E31A0405     | ALLE VINAY KUMAR                    |
| 4    | 15E31A0406     | ANNARAM BALAKRISHNA GOUD            |
| 5    | 15E31A0407     | B RAKESH                            |
| 6    | 15E31A0408     | BANDAPELLI SPOORTHY                 |
| 7    | 15E31A0409     | BHOOKYA YAKANNA                     |
| 8    | 15E31A0410     | BIRUDU HARINI                       |
| 9    | 15E31A0412     | BODDU VASU                          |
| 10   | 15E31A0413     | BONAGERI SRINIVAS                   |
| 11   | 15E31A0414     | C UMA                               |
| 12   | 15E31A0415     | D SAITEJA                           |
| 13   | 15E31A0416     | DAPPU VENKATISH                     |
| 14   | 15E31A0417     | DOSADA SOWMYA                       |
| 15   | 15E31A0418     | EDAM SAICHANDANA                    |
| 16   | 15E31A0419     | GANDLA SAICHANDRA                   |
| 17   | 15E31A0421     | GODEM MOUNIKA                       |
| 18   | 15E31A0422     | GOPI KIRAN REDDY                    |
| 19   | 15E31A0423     | GOVIND SOWMYA                       |
| 20   | 15E31A0424     | GUNTI PRAKASH                       |
| 21   | 15E31A0425     | KADICHERLA ASHWINI                  |
| 22   | 15E31A0426     | KAKILETTI JAYSURYA SRINIVASA<br>RAO |
| 23   | 15E31A0427     | KURMA DATTA SAI                     |
| 24   | 15E31A0428     | M RADHIKA                           |
| 25   | 15E31A0432     | MOUNIKA THEODSAM                    |
| 26   | 15E31A0433     | NANGUNURI VISEENU                   |
| 27   | 15E31A0435     | PABBA SUNDARA CHAITANYA             |
| 28   | 15E31A0436     | SAI SRIKANTH YADAV                  |
| 29   | 15E31A0438     | PALREDDY NARASIMHA REDDY            |
| 30   | 15E31A0439     | PASARAM SAI ABHISHEK                |

*Kshiraj*  
PRINCIPAL  
MAHAVEER  
INSTITUTE OF SCIENCE & TECHNOLOGY  
Bandlaguda, Hyd-500 005



Vysapuri, Bandlaguda Post:Keshavgiri,

Hyderabad-500 005, TELANGANA INDIA  
Tel: 040-64596979,8978380692 Fax: 040-24455003  
E-mail: [e3hod.it@gmail.com](mailto:e3hod.it@gmail.com),  
Website: [www.mist.ac.in](http://www.mist.ac.in),

# MAHAVEER

INSTITUTE OF SCIENCE & TECHNOLOGY

Approved by AICTE, Affiliated to JNTUH,Hyd.



DEPARTMENT OF ELECTRONICS AND COMMUNICATION ENGINEERING

### Technical Training MS-Office QUESTION PAPER

Duration: 120 Minutes

15 X 2 = 30 Marks

Answer the following all questions. Each question carries 1 mark.

1. How to add foot-note & end note in word?
2. What is the shortcut keys for creating hyperlink?
3. How you can insert an online picture in your word document in word 2013?
4. How you can create a custom watermark?
5. What is the short cut key to insert a page break ?
6. What is Microsoft Excel?
7. How can you add cells, rows or columns in Excel?
8. How would you format a cell? What are the options?
9. What are charts in MS Excel?
10. What is Freeze Panes in MS-Excel?
11. Is it possible to make Pivot table using multiple sources of data?
12. What are the advantages of using formula in Excel sheet?
13. What is a Macro in Excel? How to create an Excel Macro?
14. How can you show your presentation online in PowerPoint?
15. How you can record a slide-show in PowerPoint?

HOD-ECE

*Kanishk*  
PRINCIPAL  
MAHAVEER  
INSTITUTE OF SCIENCE & TECHNOLOGY  
Bandlaguda, Hyd-500 005.

Vysapuri, Bandlaguda Post:Keshavgiri,

Hyderabad-500 005, TELANGANA INDIA  
Tel: 040-64596979,8978380692,Fax: 040-24455003  
E-mail: e3hod.it@gmail.com,  
Website: www.mist.ac.in,

# MAHAVEER

INSTITUTE OF SCIENCE & TECHNOLOGY

Approved by AICTE, Affiliated to JNTUH,Hyd.



## DEPARTMENT OF ELECTRONICS AND COMMUNICATION ENGINEERING

### RESULT SHEET FOR FOR Technical Training MS-Office

| S.No | Hall Ticket No | Name of the Candidate           | ATTENDANCE(20hrs) | Marks Obtained(30) |
|------|----------------|---------------------------------|-------------------|--------------------|
| 1    | 15E31A0403     | AKULA SHUCHENDRA                | 17                | 23                 |
| 2    | 15E31A0404     | ALLA VENKATA KRISHNA VAMSHI     | 20                | 29                 |
| 3    | 15E31A0405     | ALLE VINAY KUMAR                | 18                | 23                 |
| 4    | 15E31A0406     | ANNARAM BALAKRISHNA GOUD        | 20                | 20                 |
| 5    | 15E31A0407     | B RAKESH                        | 19                | 27                 |
| 6    | 15E31A0408     | BANDAPELLI SPOORTHI             | 17                | 24                 |
| 7    | 15E31A0409     | BHOOKYA YAKANNA                 | 18                | 21                 |
| 8    | 15E31A0410     | BIRUDU HARINI                   | 20                | 25                 |
| 9    | 15E31A0412     | BODDU VASU                      | 20                | 25                 |
| 10   | 15E31A0413     | BONAGIRI SRINIVAS               | 20                | 20                 |
| 11   | 15E31A0414     | C UMA                           | 20                | 21                 |
| 12   | 15E31A0415     | D SAITEJA                       | 18                | 23                 |
| 13   | 15E31A0416     | DAPPU VENKATESH                 | 19                | 22                 |
| 14   | 15E31A0417     | DOSADA SOWMYA                   | 20                | 23                 |
| 15   | 15E31A0418     | EDAM SAICHANDANA                | 8                 | 23                 |
| 16   | 15E31A0419     | GANDLA SAICHANDRA               | 20                | 29                 |
| 17   | 15E31A0421     | GODEM MDUNIKA                   | 18                | 23                 |
| 18   | 15E31A0422     | GOPU KIRAN REDDY                | 17                | 20                 |
| 19   | 15E31A0423     | GOVIND SOWMYA                   | 20                | 27                 |
| 20   | 15E31A0424     | GUNTI PRAKASH                   | 18                | 24                 |
| 21   | 15E31A0425     | KADICHERLA ASHWINI              | 20                | 21                 |
| 22   | 15E31A0426     | KAKILETI JAISURYA SRINIVASA RAO | 19                | 25                 |
| 23   | 15E31A0427     | KURMA DATHA SAI                 | 17                | 25                 |
| 24   | 15E31A0428     | M RADHUKA                       | 18                | 20                 |
| 25   | 15E31A0432     | MOUNIKA THODSAM                 | 20                | 21                 |
| 26   | 15E31A0433     | NANGUNUR VISHNU                 | 20                | 23                 |
| 27   | 15E31A0435     | PABBA SUNDARA CHAITANYA         | 20                | 22                 |
| 28   | 15E31A0436     | SAI SRICANTH YADAV              | 20                | 23                 |
| 29   | 15E31A0438     | PALREDDY NARASIMHA REDDY        | 18                | 23                 |
| 30   | 15E31A0439     | PASARAM SAI ABHISHEK            | 19                | 29                 |

*Kanhu*

Principal  
MAHAVEER  
INSTITUTE OF SCIENCE & TECHNOLOGY  
Bandlaguda, Hyderabad-500 005

Vysapuri, Bandlaguda Post:Keshavgiri,

# MAHAVEER

INSTITUTE OF SCIENCE & TECHNOLOGY

Approved by AICTE, Affiliated to JNTUH,Hyd.



Hyderabad-500 005, TELANGANA INDIA

Tel: 040-64596979,8978380692, Fax: 040-24455003

E-mail: [e3hod.it@gmail.com](mailto:e3hod.it@gmail.com).

Website: [www.mist.ac.in](http://www.mist.ac.in).

## DEPARTMENT OF ELECTRONICS AND COMMUNICATION ENGINEERING

|    |            |                        |    |    |
|----|------------|------------------------|----|----|
| 32 | 15E31A0440 | PEDDOLLA NAVEEN REDDY  | 18 | 23 |
| 32 | 15E31A0441 | PULLUGU SUCHITHA REDDY | 19 | 29 |
| 33 | 15E31A0442 | RA GHAVENDAR PAGIDYALA | 20 | 23 |
| 34 | 15E31A0443 | RENKUNTA SAI RAM       | 18 | 20 |
| 35 | 15E31A0444 | SANA BEGUM             | 20 | 27 |
| 36 | 15E31A0445 | SAPPIDI KARTHIK REDDY  | 18 | 24 |
| 7  | 15E31A0446 | SATHI VARUN            | 17 | 21 |
| 38 | 15E31A0447 | SILAIK AMAIR HUSSAIN   | 20 | 26 |
| 39 | 15E31A0448 | SUNKARI SRINATH        | 18 | 25 |
| 40 | 15E31A0450 | THOPPARTHI SURYA TEJA  | 20 | 20 |
| 41 | 15E31A0451 | BANALLA DIVYA SAI      | 19 | 21 |
| 42 | 15E31A0455 | BOMMA PAVANI           | 17 | 23 |
| 43 | 14E31A0444 | P VINEETH REDDY        | 18 | 22 |
| 44 | 13E31A0420 | J N SrikanthBabu       | 20 | 29 |
| 45 | 14E31A0457 | V MADHU TEJA           | 20 | 23 |
| 46 | 14E31A0455 | T SHASHANK KUMAR REDDY | 18 | 20 |
| 47 | 14E31A0468 | D KALYAN               | 19 | 27 |
| 48 | 14E31A0464 | AZMEERA NIKHIL         | 18 | 24 |
| 49 | 14E31A0492 | S DEEKSHIT BEJU        | 19 | 21 |
| 50 | 14E31A04A0 | N HARI PRASAD          | 20 | 25 |
| 51 | 15E35A0410 | S RAJ KUMAR            | 18 | 25 |

*K. Babu*

PRINCIPAL  
MAHAVEER  
INSTITUTE OF SCIENCE & TECHNOLOGY  
Bandlaguda, Hyd-500 005.



Vyāpuri, Bandlaguda Post:Keshavgiri,

# MAHAVEER

INSTITUTE OF SCIENCE & TECHNOLOGY

Approved by AICTE, Affiliated to JNTUH, Hyd.



Hyderabad-500 005, TELANGANA INDIA

Tel: 040-64596979,8978386692.Fax: 040-24455003

E-mail: [e3hod.it@gmail.com](mailto:e3hod.it@gmail.com),

Website: [www.mist.ac.in](http://www.mist.ac.in),

DEPARTMENT OF ELECTRONICS AND COMMUNICATION ENGINEERING

## SUMMARY REPORT OF Technical Training MS-Office

The purpose of the **MS Word** is to allow the users to type and save documents

Microsoft **word** is used to save documents.

The documents can be copied to flash drive which serves as an external memory for your computer.

This allows you to use the saved documents conveniently taking with you anywhere.

**MS Excel** is a spreadsheet programme developed by Microsoft in 1985, with the sole purpose of helping businesses compile all their financial data, yearly credit, and yearly debit sheets.

Fast forward to the future after 31 years, it is now the most commonly used program for creating graphs and pivot tables.

Making your presentation more interesting through the use of multimedia can help to improve the audience's focus.

**PowerPoint** allows you to use images, audio and video to have a greater visual impact.

These visual and audio cues may also help a presenter be more improvisational and interactive with the audience.

  
COORDINATOR

Copy to:

1. Department Notice Board
2. Principal for Information
3. Committee Members (Academic)

  
PRINCIPAL  
MAHAVEER  
INSTITUTE OF SCIENCE & TECHNOLOGY  
Bandlaguda, Hyd-500 005

Attendance sheet for Technical Training MS-Office registered students:

| S.No | Hall Ticket No | Name of the Candidate      | 1 | 2 | 3 | 4 | 5 | 6 | 7 | 8 | 9 | 10 | 11 | 12 | 13 | 14 | 15 | 16 | 17 | 18 | 19 | 20 | ATTENDANC<br>E/20hrs |
|------|----------------|----------------------------|---|---|---|---|---|---|---|---|---|----|----|----|----|----|----|----|----|----|----|----|----------------------|
| 1    | 15E31A0400     | AKULA SURESHENDRA          | 1 | 2 | 3 | 4 | 5 | 6 | 7 | 8 | 9 | 10 | 11 | 12 | 13 | 14 | 15 | 16 | 17 | 18 | 19 | 20 | 17                   |
| 2    | 15E31A0404     | ALLA VENKATA KRISHNA       | 1 | 2 | 3 | 4 | 5 | 6 | 7 | 8 | 9 | 10 | 11 | 12 | 13 | 14 | 15 | 16 | 17 | 18 | 19 | 20 | 20                   |
| 3    | 15E31A0405     | ALLE VINAYAKUMAR           | 1 | 2 | 3 | 4 | 5 | 6 | 7 | 8 | 9 | 10 | 11 | 12 | 13 | 14 | 15 | 16 | 17 | 18 | 19 | 20 | 18                   |
| 4    | 15E31A0406     | ANNARAM BALAKRISHNA GOUD   | 1 | 2 | 3 | 4 | 5 | 6 | 7 | 8 | 9 | 10 | 11 | 12 | 13 | 14 | 15 | 16 | 17 | 18 | 19 | 20 | 20                   |
| 5    | 15E31A0407     | B BAKESH                   | 1 | 2 | 3 | 4 | 5 | 6 | 7 | 8 | 9 | 10 | 11 | 12 | 13 | 14 | 15 | 16 | 17 | 18 | 19 | 20 | 19                   |
| 6    | 15E31A0408     | BANDAPATI SPOORTE          | 1 | 2 | 3 | 4 | 5 | 6 | 7 | 8 | 9 | 10 | 11 | 12 | 13 | 14 | 15 | 16 | 17 | 18 | 19 | 20 | 17                   |
| 7    | 15E31A0409     | BHOORYA YAKANNA            | 1 | 2 | 3 | 4 | 5 | 6 | 7 | 8 | 9 | 10 | 11 | 12 | 13 | 14 | 15 | 16 | 17 | 18 | 19 | 20 | 18                   |
| 8    | 15E31A0410     | BUREDE HARINI              | 1 | 2 | 3 | 4 | 5 | 6 | 7 | 8 | 9 | 10 | 11 | 12 | 13 | 14 | 15 | 16 | 17 | 18 | 19 | 20 | 20                   |
| 9    | 15E31A0412     | BODDU VASU                 | 1 | 2 | 3 | 4 | 5 | 6 | 7 | 8 | 9 | 10 | 11 | 12 | 13 | 14 | 15 | 16 | 17 | 18 | 19 | 20 | 20                   |
| 10   | 15E31A0413     | BHUNAGIRI SRINIVAS         | 1 | 2 | 3 | 4 | 5 | 6 | 7 | 8 | 9 | 10 | 11 | 12 | 13 | 14 | 15 | 16 | 17 | 18 | 19 | 20 | 20                   |
| 11   | 15E31A0414     | C JIMA                     | 1 | 2 | 3 | 4 | 5 | 6 | 7 | 8 | 9 | 10 | 11 | 12 | 13 | 14 | 15 | 16 | 17 | 18 | 19 | 20 | 20                   |
| 12   | 15E31A0415     | D SATEJA                   | 1 | 2 | 3 | 4 | 5 | 6 | 7 | 8 | 9 | 10 | 11 | 12 | 13 | 14 | 15 | 16 | 17 | 18 | 19 | 20 | 18                   |
| 13   | 15E31A0416     | DAFRU VENKATESH            | 1 | 2 | 3 | 4 | 5 | 6 | 7 | 8 | 9 | 10 | 11 | 12 | 13 | 14 | 15 | 16 | 17 | 18 | 19 | 20 | 19                   |
| 14   | 15E31A0417     | DOSADA SOMAYA              | 1 | 2 | 3 | 4 | 5 | 6 | 7 | 8 | 9 | 10 | 11 | 12 | 13 | 14 | 15 | 16 | 17 | 18 | 19 | 20 | 20                   |
| 15   | 15E31A0418     | EDAM SAICHANDANA           | 1 | 2 | 3 | 4 | 5 | 6 | 7 | 8 | 9 | 10 | 11 | 12 | 13 | 14 | 15 | 16 | 17 | 18 | 19 | 20 | 18                   |
| 16   | 15E31A0419     | GANDLA SACHANDRA           | 1 | 2 | 3 | 4 | 5 | 6 | 7 | 8 | 9 | 10 | 11 | 12 | 13 | 14 | 15 | 16 | 17 | 18 | 19 | 20 | 20                   |
| 17   | 15E31A0421     | GODIM MOLUNKA              | 1 | 2 | 3 | 4 | 5 | 6 | 7 | 8 | 9 | 10 | 11 | 12 | 13 | 14 | 15 | 16 | 17 | 18 | 19 | 20 | 18                   |
| 18   | 15E31A0422     | GOPI KIRAN REDDY           | 1 | 2 | 3 | 4 | 5 | 6 | 7 | 8 | 9 | 10 | 11 | 12 | 13 | 14 | 15 | 16 | 17 | 18 | 19 | 20 | 17                   |
| 19   | 15E31A0423     | GOVIND SOMAYA              | 1 | 2 | 3 | 4 | 5 | 6 | 7 | 8 | 9 | 10 | 11 | 12 | 13 | 14 | 15 | 16 | 17 | 18 | 19 | 20 | 20                   |
| 20   | 15E31A0424     | GUNTI NARASH               | 1 | 2 | 3 | 4 | 5 | 6 | 7 | 8 | 9 | 10 | 11 | 12 | 13 | 14 | 15 | 16 | 17 | 18 | 19 | 20 | 18                   |
| 21   | 15E31A0425     | KADICHEELA ASHWINI         | 1 | 2 | 3 | 4 | 5 | 6 | 7 | 8 | 9 | 10 | 11 | 12 | 13 | 14 | 15 | 16 | 17 | 18 | 19 | 20 | 20                   |
| 22   | 15E31A0426     | KAKULETI JASURYA SRINIVASA | 1 | 2 | 3 | 4 | 5 | 6 | 7 | 8 | 9 | 10 | 11 | 12 | 13 | 14 | 15 | 16 | 17 | 18 | 19 | 20 | 19                   |
| 23   | 15E31A0427     | KURMA DATTA SAI            | 1 | 2 | 3 | 4 | 5 | 6 | 7 | 8 | 9 | 10 | 11 | 12 | 13 | 14 | 15 | 16 | 17 | 18 | 19 | 20 | 17                   |
| 24   | 15E31A0428     | M RADHKA                   | 1 | 2 | 3 | 4 | 5 | 6 | 7 | 8 | 9 | 10 | 11 | 12 | 13 | 14 | 15 | 16 | 17 | 18 | 19 | 20 | 18                   |
| 25   | 15E31A0432     | MOUNIKA THODAM             | 1 | 2 | 3 | 4 | 5 | 6 | 7 | 8 | 9 | 10 | 11 | 12 | 13 | 14 | 15 | 16 | 17 | 18 | 19 | 20 | 20                   |
| 26   | 15E31A0433     | MANGUNURI SISHNU           | 1 | 2 | 3 | 4 | 5 | 6 | 7 | 8 | 9 | 10 | 11 | 12 | 13 | 14 | 15 | 16 | 17 | 18 | 19 | 20 | 20                   |
| 27   | 15E31A0435     | PABBA SUNDARA CHAITANYA    | 1 | 2 | 3 | 4 | 5 | 6 | 7 | 8 | 9 | 10 | 11 | 12 | 13 | 14 | 15 | 16 | 17 | 18 | 19 | 20 | 20                   |
| 28   | 15E31A0436     | SAI SRIKANTH YADAV         | 1 | 2 | 3 | 4 | 5 | 6 | 7 | 8 | 9 | 10 | 11 | 12 | 13 | 14 | 15 | 16 | 17 | 18 | 19 | 20 | 18                   |
| 29   | 15E31A0438     | PALIREDDY NARASIMHA REDDY  | 1 | 2 | 3 | 4 | 5 | 6 | 7 | 8 | 9 | 10 | 11 | 12 | 13 | 14 | 15 | 16 | 17 | 18 | 19 | 20 | 19                   |
| 30   | 15E31A0439     | PASARAM SAIBHISHIK         | 1 | 2 | 3 | 4 | 5 | 6 | 7 | 8 | 9 | 10 | 11 | 12 | 13 | 14 | 15 | 16 | 17 | 18 | 19 | 20 | 19                   |
| 31   | 15E31A0440     | PIEDDILLA NAVIEN REDDY     | 1 | 2 | 3 | 4 | 5 | 6 | 7 | 8 | 9 | 10 | 11 | 12 | 13 | 14 | 15 | 16 | 17 | 18 | 19 | 20 | 19                   |

Benches: 190-500 each



|    |            |                        |   |   |   |   |   |   |   |   |   |    |    |    |    |    |    |    |    |    |    |    |
|----|------------|------------------------|---|---|---|---|---|---|---|---|---|----|----|----|----|----|----|----|----|----|----|----|
| 32 | 15E31A0441 | PULIGRE SUCHITHA REDDY | 1 | 2 | 3 | 4 | 5 | 6 | 7 | 8 | 9 | 10 | 11 | 12 | 13 | 14 | 15 | 16 | 17 | 18 | 19 |    |
| 33 | 15E31A0442 | BAGHAVENDAR PAGDYALA   | 1 | 2 | 3 | 4 | 5 | 6 | 7 | 8 | 9 | 10 | 11 | 12 | 13 | 14 | 15 | 16 | 17 | 18 | 19 | 20 |
| 34 | 15E31A0443 | BENIKUNTA SAURAM       | 1 | 2 | 3 | 4 | 5 | 6 | 7 | 8 | 9 | 10 | A  | 11 | 12 | 13 | 14 | 15 | 16 | 17 | 18 | 19 |
| 35 | 15E31A0444 | SANA BEGUM             | 1 | 2 | 3 | 4 | 5 | 6 | 7 | 8 | 9 | 10 | 11 | 12 | 13 | 14 | 15 | 16 | 17 | 18 | 19 | 20 |
| 36 | 15E31A0445 | SAPPIER KARTHIK REDDY  | 1 | 2 | 3 | 4 | 5 | 6 | 7 | 8 | 9 | 10 | 11 | 12 | 13 | 14 | 15 | 16 | 17 | 18 | 19 | 20 |
| 37 | 15E31A0446 | BATHI VARUN            | 1 | 2 | 3 | 4 | 5 | 6 | 7 | 8 | 9 | 10 | 11 | A  | 12 | 13 | 14 | 15 | 16 | 17 | 18 | 19 |
| 38 | 15E31A0447 | SHAIK AMAIR HUSSAIN    | 1 | 2 | 3 | 4 | 5 | 6 | 7 | 8 | 9 | 10 | 11 | 12 | 13 | 14 | 15 | 16 | 17 | 18 | 19 | 20 |
| 39 | 15E31A0448 | SUNKAR SRINATH         | 1 | 2 | 3 | 4 | 5 | 6 | 7 | 8 | 9 | 10 | 11 | 12 | 13 | 14 | 15 | 16 | 17 | 18 | 19 | 20 |
| 40 | 15E31A0450 | THIPPARTHI SUREYA TEJA | 1 | 2 | 3 | 4 | 5 | 6 | 7 | 8 | 9 | 10 | 11 | 12 | 13 | 14 | 15 | 16 | 17 | 18 | 19 | 20 |
| 41 | 15E31A0453 | BANALLA DIVYA SW       | 1 | 2 | 3 | 4 | 5 | 6 | 7 | 8 | 9 | 10 | 11 | 12 | 13 | 14 | 15 | 16 | 17 | 18 | 19 | 20 |
| 42 | 15E31A0455 | BOMMA PAVANI           | 1 | 2 | 3 | 4 | 5 | 6 | 7 | 8 | 9 | 10 | A  | 11 | 12 | 13 | 14 | 15 | 16 | 17 | 18 | 19 |
| 43 | 14E31A0444 | P VINIETHI REDDY       | 1 | 2 | 3 | 4 | 5 | 6 | 7 | 8 | 9 | 10 | 11 | 12 | 13 | 14 | 15 | 16 | 17 | 18 | 19 | 20 |
| 44 | 13E31A0420 | J N Srilakshmi         | 1 | 2 | 3 | 4 | 5 | 6 | 7 | 8 | 9 | 10 | 11 | 12 | 13 | 14 | 15 | 16 | 17 | 18 | 19 | 20 |
| 45 | 14E31A0457 | V MADHU TEJA           | 1 | 2 | 3 | 4 | 5 | 6 | 7 | 8 | 9 | 10 | 11 | 12 | 13 | 14 | 15 | 16 | 17 | 18 | 19 | 20 |
| 46 | 14E31A0455 | T SHASHANK KUMAR REDDY | 1 | 2 | 3 | 4 | 5 | 6 | 7 | 8 | 9 | 10 | 11 | 12 | 13 | 14 | 15 | 16 | 17 | 18 | 19 | 20 |
| 47 | 14E31A0468 | D KALYAN               | 1 | 2 | 3 | 4 | 5 | 6 | 7 | 8 | 9 | 10 | 11 | 12 | 13 | 14 | 15 | 16 | 17 | 18 | 19 | 20 |
| 48 | 14E31A0464 | AZMEERA NIKHIL         | 1 | 2 | 3 | 4 | 5 | 6 | 7 | 8 | 9 | 10 | 11 | 12 | 13 | 14 | 15 | 16 | 17 | 18 | 19 | 20 |
| 49 | 14E31A0492 | S DEEKSHIT REJU        | 1 | 2 | 3 | 4 | 5 | 6 | 7 | 8 | 9 | 10 | 11 | 12 | 13 | 14 | 15 | 16 | 17 | 18 | 19 | 20 |
| 50 | 14E31A0440 | N HARI PRASAD          | 1 | 2 | 3 | 4 | 5 | 6 | 7 | 8 | 9 | 10 | 11 | 12 | 13 | 14 | 15 | 16 | 17 | 18 | 19 | 20 |
| 51 | 15E31A0410 | S RAJ KUMAR            | 1 | 2 | 3 | 4 | 5 | 6 | 7 | 8 | 9 | 10 | A  | 11 | 12 | 13 | 14 | 15 | 16 | 17 | 18 | 19 |

*[Signature]*  
Co-ordinator

*[Signature]*  
HOD, ECE Dept

**MAHA VEER**  
PRINCIPAL  
INSTITUTE OF SCIENCE & TECHNOLOGY  
BANDRUGUDA, HYD-500 005.



Vysapuri, Bandlaguda Post:Keshavgi,

Hyderabad-500 005, TELANGANA INDIA

Tel: 040-64596979,8978380692,Fax: 040-24455003

E-mail: [e3hod.it@gmail.com](mailto:e3hod.it@gmail.com),

Website: [www.mist.ac.in](http://www.mist.ac.in),

# MAHAVEER

INSTITUTE OF SCIENCE & TECHNOLOGY

Approved by AICTE, Affiliated to JNTUH,Hyd



DEPARTMENT OF ELECTRONICS AND COMMUNICATION ENGINEERING

Date: 02-01-2017

CIRCULAR

Technical Trainings for **Cloud computing** III & IV B. Tech students are starting from **21-01-2017** onwards. All the students III year ,B.Tech I Semester should attend.

Design and development of curriculum for add-on courses :

Faculty Names: 1.Prof. B.Visweswara Rao  
2. Dr. V. Gunashekhar Reddy  
3. Mr. Ch. Sandeep Kumar

HOD, ECE

Cc: Principal for information  
: Coordinator to inform the students  
: Notice board & department File.



PRINCIPAL  
MAHAVEER  
INSTITUTE OF SCIENCE & TECHNOLOGY  
Bandlaguda, Hyd-500 005.

Vysapuri, Bandlaguda Post:Keshavgiri,

# MAHAVEER

INSTITUTE OF SCIENCE & TECHNOLOGY

Approved by AICTE, Affiliated to JNTUH,Hyd.



Hyderabad-500 005, TELANGANA INDIA

Tel: 040-64596979,8978380692 Fax: 040-24455003

E-mail: [e3hod.it@gmail.com](mailto:e3hod.it@gmail.com),

Website: [www.mist.ac.in](http://www.mist.ac.in),

DEPARTMENT OF ELECTRONICS AND COMMUNICATION ENGINEERING

## SYLLABUS FOR Cloud computing

| SNO | TOPIC COVERED                                   | DURATION |
|-----|---|----------|
| 1   | Introduction to Cloud Computing                 | 3        |
| 2   | Adopting the Cloud                              | 3        |
| 3   | Exploiting Software as a Service (SaaS)         | 3        |
| 4   | Delivering Platform as a Service (PaaS)         | 3        |
| 5   | Deploying Infrastructure as a Service (IaaS)    | 3        |
| 6   | Building a Business Case                        | 3        |
| 7   | Migrating to the Cloud                          | 3        |
| 8   | Introduction to Hadoop                          | 3        |
| 9   | Hadoop Architecture, Distributed Storage & YARN | 3        |
| 10  | Data Ingestion into Big Data Systems            | 3        |
| 11  | Distributed Processing                          | 3        |
| 12  | Apache Hive                                     | 3        |
| 13  | NoSQL Data bases-HBase                          | 3        |

  
HOD-ECE

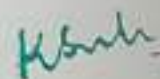

PRINCIPAL  
MAHAVEER  
INSTITUTE OF SCIENCE & TECHNOLOGY  
bandlaguda, hyd-500 005

Vysapuri, Bandlaguda Post:Keshavgi,ri,

Hyderabad-500 005, TELANGANA INDIA  
Tel: 040-64596979,8978380692 Fax: 040-24455003  
E-mail: e3hod.it@gmail.com,  
Website: www.mist.ac.in,

# MAHAVEER

INSTITUTE OF SCIENCE & TECHNOLOGY  
Approved by AICTE, Affiliated to JNTUH,Hyd



DEPARTMENT OF ELECTRONICS AND COMMUNICATION ENGINEERING

### LIST OF REGISTERED STUDENTS FOR Cloud computing

| S.No | Hall Ticket No | Name of the Candidate           |
|------|----------------|---------------------------------|
| 1    | 15E31A0403     | AKULA SHUCHENDRA                |
| 2    | 15E31A0404     | ALLA VENKATA KRISHNA VAMSHI     |
| 3    | 15E31A0405     | ALLE VINAY KUMAR                |
| 4    | 15E31A0406     | ANNARAM BALAKRISHNA GOUD        |
| 5    | 15E31A0407     | B RAKESH                        |
| 6    | 15E31A0408     | BANDAPPELLI SPOORTHI            |
| 7    | 15E31A0409     | BHOKYA YAKANNA                  |
| 8    | 15E31A0410     | BIRUDU HARINI                   |
| 9    | 15E31A0412     | BODDU VASU                      |
| 10   | 15E31A0413     | BONAGIRE SRINIVAS               |
| 11   | 15E31A0414     | CUMA                            |
| 12   | 15E31A0415     | D SAITEJA                       |
| 13   | 15E31A0416     | DAPPU VENKATESH                 |
| 14   | 15E31A0417     | DOSADA SOWMYA                   |
| 15   | 15E31A0418     | EDAMSA CHANDANA                 |
| 16   | 15E31A0419     | GANTLA SAICHANDRA               |
| 17   | 15E31A0421     | GEDEM NOUNIKA                   |
| 18   | 15E31A0422     | GOPU KIRAN REDDY                |
| 19   | 15E31A0423     | GOVIND SOWMYA                   |
| 20   | 15E31A0424     | GUNTI PRAKASH                   |
| 21   | 15E31A0425     | KADICHERLA ASHWINI              |
| 22   | 15E31A0426     | KAKILETI JAISURYA SRINIVASA RAO |
| 23   | 15E31A0427     | KURMA DATHA SAI                 |
| 24   | 15E31A0428     | MIRADHIKA                       |
| 25   | 15E31A0432     | MOUNIKA THOOSAM                 |
| 26   | 15E31A0433     | NANDUNURI VISHNU                |
| 27   | 15E31A0435     | PABBA SUNDARA CHAITANYA         |
| 28   | 15E31A0436     | SAI SRIKANTH YADAV              |
| 29   | 15E31A0438     | PALREDDY NARASIMHA REDDY        |
| 30   | 15E31A0439     | PASARAM SAI ABHISHEK            |

*K. Sankar*  
PRINCIPAL  
MAHAVEER  
INSTITUTE OF SCIENCE & TECHNOLOGY  
Bandlaguda, Hyd - 500 005.



Vysapuri, Bandlaguda Post Keshavgiri,

Hyderabad-500 005, TELANGANA INDIA  
Tel: 040-64596979,8978380692 Fax: 040-24466093  
E-mail: [s3hod.it@gmail.com](mailto:s3hod.it@gmail.com),  
Website: [www.mist.ac.in](http://www.mist.ac.in),

# MAHAVEER

INSTITUTE OF SCIENCE & TECHNOLOGY  
Approved by AICTE, Affiliated to JNTUH,Hyd.



## DEPARTMENT OF ELECTRONICS AND COMMUNICATION ENGINEERING

|    |            |                         |
|----|------------|-------------------------|
| 31 | 15E31A0440 | PEDDELLA NAVJYOT REDDY  |
| 32 | 15E31A0441 | PULLOORUCHITSJA REDDY   |
| 33 | 15E31A0442 | RAGHAYENDAK PAGIDYALA   |
| 34 | 15E31A0443 | RENIKUNTA SARAM         |
| 35 | 15E31A0444 | SANA BODUM              |
| 36 | 15E31A0445 | SAJJIDI KARTHIK REDDY   |
| 7  | 15E31A0446 | SATHI VARUN             |
| 38 | 15E31A0447 | SHAIK AMAR HUSSAIN      |
| 39 | 15E31A0448 | SUNKARI SRINATH         |
| 40 | 15E31A0450 | THEPPAKOTHI SURYA TEJA  |
| 41 | 15E31A0453 | BANALEA DIVYA SAI       |
| 42 | 15E31A0455 | IKHMA PAYANI            |
| 43 | 15E31A0444 | P VIBHUTHI REDDY        |
| 44 | 15E31A0420 | JN Srikanth Babu        |
| 45 | 14E31A0457 | V MADHU TEJA            |
| 46 | 14E31A0455 | T SHARBEANU KUMAR REDDY |
| 47 | 14E31A0468 | D KALYAN                |
| 48 | 14E31A0464 | AZMEERA NIKHIL          |
| 49 | 14E31A0492 | S DEEKSHIT JESU         |
| 50 | 14E31A0450 | N HARI PRASAD           |
| 51 | 15E31A0410 | S RAJ KUMAR             |

*[Handwritten Signature]*

PRINCIPAL  
MAHAVEER  
INSTITUTE OF SCIENCE & TECHNOLOGY  
Bandlaguda, Hyd-500 005.

Vysapuri, Bandlaguda Post:Keshavgiri,

Hyderabad-500 005, TELANGANA INDIA  
Tel: 040-64596979,8978380692 Fax: 040-24455093  
E-mail: [e3hod.it@gmail.com](mailto:e3hod.it@gmail.com),  
Website: [www.mist.ac.in](http://www.mist.ac.in),

# MAHAVEER

INSTITUTE OF SCIENCE & TECHNOLOGY

Approved by AICTE, Affiliated to JNTUH,Hyd.



DEPARTMENT OF ELECTRONICS AND COMMUNICATION ENGINEERING

## Cloud computing QUESTION PAPER

Duration: 120

Minutes 10 X 3 = 300 Marks

Answer the following all questions. Each question carries 2 marks.

1. What is cloud computing?
2. What are the types of cloud?
3. What are the benefits of cloud computing?
4. Is the cloud secure?
5. How do I develop a cloud strategy?
6. What is Hadoop and its components.
7. What are HDFS and YARN?
8. Compare HDFS with Network Attached Storage (NAS).
9. List the difference between Hadoop 1 and Hadoop 2.
10. What happens when two clients try to access the same file in the HDFS?

  
HOD-EC

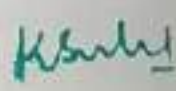
  
PRINCIPAL  
MAHAVEER  
INSTITUTE OF SCIENCE & TECHNOLOGY  
Bandlaguda, Hyd-500 005.

Vysapuri, Bandlaguda Post: Keshavgi,

# MAHAVEER

INSTITUTE OF SCIENCE & TECHNOLOGY

Approved by AICTE, Affiliated to JNTUH, Hyd.



Hyderabad-500 005, TELANGANA INDIA

Tel: 040-64596979, 8978380692, Fax: 040-24455003

E-mail: [e3hod.it@gmail.com](mailto:e3hod.it@gmail.com),

Website: [www.mist.ac.in](http://www.mist.ac.in),

## DEPARTMENT OF INFORMATION TECHNOLOGY

### RESULT SHEET FOR Cloud computing REGISTERED STUDENTS

| S.No | Hall Ticket No | Name of the Candidate           | ATTENDANCE(20hrs) | Marks Obtained(30) |
|------|----------------|---------------------------------|-------------------|--------------------|
| 1    | 15E31A0403     | AKULA SHUCHENDRA                | 17                | 23                 |
| 2    | 15E31A0404     | ALLA VENKATA KRISHNA VAMSHI     | 20                | 29                 |
| 3    | 15E31A0405     | ALLE VINAY KUMAR                | 18                | 23                 |
| 4    | 15E31A0406     | ANNARAM BALAKRISHNA GOUD        | 20                | 20                 |
| 5    | 15E31A0407     | B BAKESH                        | 19                | 27                 |
| 6    | 15E31A0408     | BANDAPELLI SPOOR THI            | 17                | 24                 |
| 7    | 15E31A0409     | BHOOKYA YAKANNA                 | 18                | 21                 |
| 8    | 15E31A0410     | BREDDU HARINI                   | 20                | 25                 |
| 9    | 15E31A0412     | BODDU VASU                      | 20                | 25                 |
| 10   | 15E31A0413     | BONAGIRI SRINIVAS               | 20                | 20                 |
| 11   | 15E31A0414     | C UMA                           | 20                | 21                 |
| 12   | 15E31A0415     | D SAITEJA                       | 18                | 21                 |
| 13   | 15E31A0416     | DAPPU VENKATISH                 | 19                | 22                 |
| 14   | 15E31A0417     | DOSADA SOWMYA                   | 20                | 23                 |
| 15   | 15E31A0418     | EDAM SAICHANDANA                | 18                | 23                 |
| 16   | 15E31A0419     | GANDLA SAICHANDRA               | 20                | 29                 |
| 17   | 15E31A0421     | GODEM MOUNIKA                   | 18                | 23                 |
| 18   | 15E31A0422     | GOPU KIRAN REDDY                | 17                | 20                 |
| 19   | 15E31A0423     | GOVIND SOWMYA                   | 20                | 27                 |
| 20   | 15E31A0424     | GUNTI PRAKASH                   | 18                | 24                 |
| 21   | 15E31A0425     | KADICHERLA ASHWINI              | 20                | 21                 |
| 22   | 15E31A0426     | KAKILETI JAISURYA SRINIVASA RAO | 19                | 25                 |
| 23   | 15E31A0427     | KURMA DATHA SAI                 | 17                | 25                 |
| 24   | 15E31A0428     | M RADHIKA                       | 18                | 20                 |
| 25   | 15E31A0432     | MOUNIKA THODSAM                 | 20                | 21                 |
| 26   | 15E31A0433     | NANGUNURI VISHNU                | 20                | 23                 |
| 27   | 15E31A0435     | PABBA SUNDARA CHAITANYA         | 20                | 22                 |
| 28   | 15E31A0436     | SAI SRUKANTH YADAV              | 20                | 23                 |
| 29   | 15E31A0438     | PALREDDY NARASIMHA REDDY        | 18                | 23                 |
| 30   | 15E31A0439     | PASARAM SAI ABHISHEK            | 19                | 29                 |

*[Handwritten Signature]*

PRINCIPAL  
MAHAVEER  
INSTITUTE OF SCIENCE & TECHNOLOGY  
Bandlaguda, Hyd-500 005



Vysapuri, Bandlaguda Post:Keshavgiri,

# MAHAVEER

INSTITUTE OF SCIENCE & TECHNOLOGY

Approved by AICTE, Affiliated to JNTUH,Hyd.



Hyderabad-500 005, TELANGANA INDIA

Tel: 040-64596979,8978380692, Fax: 040-24455003

E-mail: e3hod.it@gmail.com.

Website: www.mist.ac.in,

DEPARTMENT OF ELECTRONICS AND COMMUNICATION ENGINEERING

|    |            |                        |    |    |
|----|------------|------------------------|----|----|
| 32 | 15E31A0440 | PEDDOLLA NAVEEN REDDY  | 18 | 23 |
| 32 | 15E31A0441 | PULUGU SUCHITHA REDDY  | 19 | 20 |
| 33 | 15E31A0442 | RAGHAVENDAR PAGIDYALA  | 20 | 23 |
| 34 | 15E31A0443 | RENKUNTA ABIRAM        | 18 | 20 |
| 35 | 15E31A0444 | SANA BEGUM             | 20 | 27 |
| 36 | 15E31A0445 | SAPPIDI KARTHIK REDDY  | 18 | 24 |
| 7  | 15E31A0446 | SATHI VARUN            | 17 | 21 |
| 38 | 15E31A0447 | SHAIK AMAIR TUSSAIN    | 20 | 25 |
| 39 | 15E31A0448 | SUNKARI SRINATH        | 18 | 25 |
| 40 | 15E31A0450 | THEPPARTHI SURYA TEJA  | 20 | 20 |
| 41 | 15E31A0453 | BANALLA DIVYA SAI      | 19 | 21 |
| 42 | 15E31A0455 | BOMMA PAVANI           | 17 | 23 |
| 43 | 14E31A0444 | P VINEETH REDDY        | 18 | 22 |
| 44 | 13E31A0420 | J N Sankar Babu        | 20 | 29 |
| 45 | 14E31A0457 | V MADHU TEJA           | 20 | 23 |
| 46 | 14E31A0455 | T SHASHANK KUMAR REDDY | 18 | 20 |
| 47 | 14E31A0468 | D KAIYAN               | 19 | 27 |
| 48 | 14E31A0464 | AZMEERA NIKHIL         | 18 | 24 |
| 49 | 14E31A0492 | S DEEKSHIT REJU        | 19 | 21 |
| 50 | 14E31A04A0 | N HARI PRASAD          | 20 | 25 |
| 51 | 15E35A0410 | S RAJ KUMAR            | 18 | 25 |

*K. S. S.*

PRINCIPAL  
M. AVEER  
INSTITUTE OF SCIENCE & TECHNOLOGY  
Bandlaguda, Hyd-500 005.

Vysapuri, Bandlaguda Post:Keshavgiri,

Hyderabad-500 005, TELANGANA INDIA

Tel: 040-64596979,8978380692 Fax: 040-24455003

E-mail: [e3hod.it@gmail.com](mailto:e3hod.it@gmail.com),

Website: [www.mist.ac.in](http://www.mist.ac.in),

# MAHAVEER

INSTITUTE OF SCIENCE & TECHNOLOGY

Approved by AICTE, Affiliated to JNTUH,Hyd.



DEPARTMENT OF ELECTRONICS AND COMMUNICATION ENGINEERING

## SUMMARY REPORT OF Cloud computing

Cloud computing is perhaps the most flamboyant technological innovation of the 21st century. This is because it has seen the fastest adoption into the mainstream than any other technology in the domain.

This adoption has been fueled mainly by the ever-increasing number of smart phones and mobile devices that can access the internet.

Cloud computing is not just for organizations and businesses; it's also useful for the average person as well.

It enables us to run software programs without installing them on our computers; it enables us to store and access our multimedia content via the internet, it enables us to develop and test programs without necessarily having servers and so on.

Hadoop is an open source platform that provides excellent data management provision.

It is a framework that supports the processing of large data sets in a distributed computing environment.

It is designed to expand from single servers to thousands of machines, each providing computation and storage.

Its distributed file system facilitates rapid data transfer rates among nodes and allows the system to continue operating uninterrupted in case of a node failure, which minimizes the risk of catastrophic system failure, even if a significant number of nodes become out of action.

  
COORDINATOR

Copy to:

1. Department Notice Board
2. Principal for Information
3. Committee Members (Academic)

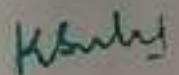

PRINCIPAL  
MAHAVEER  
INSTITUTE OF SCIENCE & TECHNOLOGY  
Bandlaguda, Hyd-500 005

Attendance sheet for CLOUD COMPUTING registered students:

| S.no | Roll Ticket No | Name of the Candidate           | 1 | 2 | 3 | 4 | 5 | 6 | 7 | 8 | 9 | 10 | 11 | 12 | 13 | 14 | 15 | 16 | 17 | 18 | 19 | 20 | ATTEN<br>DANCE<br>NCE(20/100) |
|------|----------------|---------------------------------|---|---|---|---|---|---|---|---|---|----|----|----|----|----|----|----|----|----|----|----|-------------------------------|
| 1    | 15E31A0403     | AKULA SHEKHENDRA                | 1 | 2 | 3 | 4 | 5 | 6 | 7 | 8 | 9 | 10 | 11 | 12 | 13 | 14 | 15 | 16 | 17 | 18 | 19 | 20 | 17                            |
| 2    | 15E31A0404     | ALLA VENKATA KRISHNA VAMISHI    | 1 | 2 | 3 | 4 | 5 | 6 | 7 | 8 | 9 | 10 | 11 | 12 | 13 | 14 | 15 | 16 | 17 | 18 | 19 | 20 | 20                            |
| 3    | 15E31A0405     | ALLE VINAY KUMAR                | 1 | 2 | 3 | 4 | 5 | 6 | 7 | 8 | 9 | 10 | 11 | 12 | 13 | 14 | 15 | 16 | 17 | 18 | 19 | 20 | 18                            |
| 4    | 15E31A0406     | ANNABAM BALAKRISHNA GOUD        | 1 | 2 | 3 | 4 | 5 | 6 | 7 | 8 | 9 | 10 | 11 | 12 | 13 | 14 | 15 | 16 | 17 | 18 | 19 | 20 | 20                            |
| 5    | 15E31A0407     | B RAKESH                        | 1 | 2 | 3 | 4 | 5 | 6 | 7 | 8 | 9 | 10 | 11 | 12 | 13 | 14 | 15 | 16 | 17 | 18 | 19 | 20 | 19                            |
| 6    | 15E31A0408     | BANDAPELLI SPOORTHI             | 1 | 2 | 3 | 4 | 5 | 6 | 7 | 8 | 9 | 10 | 11 | 12 | 13 | 14 | 15 | 16 | 17 | 18 | 19 | 20 | 17                            |
| 7    | 15E31A0409     | BHOOKYA YAKANNA                 | 1 | 2 | 3 | 4 | 5 | 6 | 7 | 8 | 9 | 10 | 11 | 12 | 13 | 14 | 15 | 16 | 17 | 18 | 19 | 20 | 18                            |
| 8    | 15E31A0410     | BIRUDU HARINI                   | 1 | 2 | 3 | 4 | 5 | 6 | 7 | 8 | 9 | 10 | 11 | 12 | 13 | 14 | 15 | 16 | 17 | 18 | 19 | 20 | 20                            |
| 9    | 15E31A0412     | BODDU VASU                      | 1 | 2 | 3 | 4 | 5 | 6 | 7 | 8 | 9 | 10 | 11 | 12 | 13 | 14 | 15 | 16 | 17 | 18 | 19 | 20 | 20                            |
| 10   | 15E31A0413     | BONAGIRI SRINIVAS               | 1 | 2 | 3 | 4 | 5 | 6 | 7 | 8 | 9 | 10 | 11 | 12 | 13 | 14 | 15 | 16 | 17 | 18 | 19 | 20 | 20                            |
| 11   | 15E31A0414     | C.TIMA                          | 1 | 2 | 3 | 4 | 5 | 6 | 7 | 8 | 9 | 10 | 11 | 12 | 13 | 14 | 15 | 16 | 17 | 18 | 19 | 20 | 20                            |
| 12   | 15E31A0415     | D.SATEJA                        | 1 | 2 | 3 | 4 | 5 | 6 | 7 | 8 | 9 | 10 | 11 | 12 | 13 | 14 | 15 | 16 | 17 | 18 | 19 | 20 | 18                            |
| 13   | 15E31A0416     | DAPPU VENKATESH                 | 1 | 2 | 3 | 4 | 5 | 6 | 7 | 8 | 9 | 10 | 11 | 12 | 13 | 14 | 15 | 16 | 17 | 18 | 19 | 20 | 19                            |
| 14   | 15E31A0417     | DOSADA SOWMYA                   | 1 | 2 | 3 | 4 | 5 | 6 | 7 | 8 | 9 | 10 | 11 | 12 | 13 | 14 | 15 | 16 | 17 | 18 | 19 | 20 | 20                            |
| 15   | 15E31A0418     | EDAM SAICHANDANA                | 1 | 2 | 3 | 4 | 5 | 6 | 7 | 8 | 9 | 10 | 11 | 12 | 13 | 14 | 15 | 16 | 17 | 18 | 19 | 20 | 18                            |
| 16   | 15E31A0419     | GANDLA SAICHANDRA               | 1 | 2 | 3 | 4 | 5 | 6 | 7 | 8 | 9 | 10 | 11 | 12 | 13 | 14 | 15 | 16 | 17 | 18 | 19 | 20 | 20                            |
| 17   | 15E31A0421     | GODEM MOJUNIKA                  | 1 | 2 | 3 | 4 | 5 | 6 | 7 | 8 | 9 | 10 | 11 | 12 | 13 | 14 | 15 | 16 | 17 | 18 | 19 | 20 | 18                            |
| 18   | 15E31A0422     | GOPU KIRAN REDDY                | 1 | 2 | 3 | 4 | 5 | 6 | 7 | 8 | 9 | 10 | 11 | 12 | 13 | 14 | 15 | 16 | 17 | 18 | 19 | 20 | 17                            |
| 19   | 15E31A0423     | GOVIND SOWMYA                   | 1 | 2 | 3 | 4 | 5 | 6 | 7 | 8 | 9 | 10 | 11 | 12 | 13 | 14 | 15 | 16 | 17 | 18 | 19 | 20 | 20                            |
| 20   | 15E31A0424     | GUNTI PRAKASH                   | 1 | 2 | 3 | 4 | 5 | 6 | 7 | 8 | 9 | 10 | 11 | 12 | 13 | 14 | 15 | 16 | 17 | 18 | 19 | 20 | 18                            |
| 21   | 15E31A0425     | KADRICHELLA ASHWINI             | 1 | 2 | 3 | 4 | 5 | 6 | 7 | 8 | 9 | 10 | 11 | 12 | 13 | 14 | 15 | 16 | 17 | 18 | 19 | 20 | 20                            |
| 22   | 15E31A0426     | KARLETTI JAISURYA SRINIVASA RAO | 1 | 2 | 3 | 4 | 5 | 6 | 7 | 8 | 9 | 10 | 11 | 12 | 13 | 14 | 15 | 16 | 17 | 18 | 19 | 20 | 19                            |
| 23   | 15E31A0427     | KURUMA DATHA SAI                | 1 | 2 | 3 | 4 | 5 | 6 | 7 | 8 | 9 | 10 | 11 | 12 | 13 | 14 | 15 | 16 | 17 | 18 | 19 | 20 | 17                            |
| 24   | 15E31A0428     | M RADHIKA                       | 1 | 2 | 3 | 4 | 5 | 6 | 7 | 8 | 9 | 10 | 11 | 12 | 13 | 14 | 15 | 16 | 17 | 18 | 19 | 20 | 18                            |
| 25   | 15E31A0432     | MIDUNILA THEODRAM               | 1 | 2 | 3 | 4 | 5 | 6 | 7 | 8 | 9 | 10 | 11 | 12 | 13 | 14 | 15 | 16 | 17 | 18 | 19 | 20 | 20                            |
| 26   | 15E31A0433     | MANGUNURI VISHNU                | 1 | 2 | 3 | 4 | 5 | 6 | 7 | 8 | 9 | 10 | 11 | 12 | 13 | 14 | 15 | 16 | 17 | 18 | 19 | 20 | 20                            |
| 27   | 15E31A0435     | PABBA SUNDARA CHAITANYA         | 1 | 2 | 3 | 4 | 5 | 6 | 7 | 8 | 9 | 10 | 11 | 12 | 13 | 14 | 15 | 16 | 17 | 18 | 19 | 20 | 20                            |
| 28   | 15E31A0436     | SAI SRIRAMTH YADAV              | 1 | 2 | 3 | 4 | 5 | 6 | 7 | 8 | 9 | 10 | 11 | 12 | 13 | 14 | 15 | 16 | 17 | 18 | 19 | 20 | 20                            |
| 29   | 15E31A0438     | PALAREDDY NARASIMHA REDDY       | 1 | 2 | 3 | 4 | 5 | 6 | 7 | 8 | 9 | 10 | 11 | 12 | 13 | 14 | 15 | 16 | 17 | 18 | 19 | 20 | 20                            |
| 30   | 15E31A0439     | PASARAM SAI ABHISHIEK           | 1 | 2 | 3 | 4 | 5 | 6 | 7 | 8 | 9 | 10 | 11 | 12 | 13 | 14 | 15 | 16 | 17 | 18 | 19 | 20 | 18                            |



|    |            |                        |   |   |   |   |   |   |   |   |   |    |    |    |    |    |    |    |    |    |    |    |
|----|------------|------------------------|---|---|---|---|---|---|---|---|---|----|----|----|----|----|----|----|----|----|----|----|
| 31 | 14E31A0440 | PEDDILLA NAVEN REDDY   | 1 | 2 | A | 3 | 4 | 5 | 6 | 7 | A | 5  | 9  | 10 | 11 | 12 | 13 | 14 | 15 | 16 | 17 | 18 |
| 32 | 14E31A0441 | PULLUGU ECHITHRA REDDY | 1 | 2 | 3 | 4 | 5 | 6 | 7 | 8 | 9 | 10 | 11 | 12 | A  | 13 | 14 | 15 | 16 | 17 | 18 | 19 |
| 33 | 14E31A0442 | BAGHAVENDAR PADIDYALA  | 1 | 2 | 3 | 4 | 5 | 6 | 7 | 8 | 9 | 10 | 11 | 12 | 13 | 14 | 15 | 16 | 17 | 18 | 19 | 20 |
| 34 | 14E31A0443 | RENIKUNTA SAIRAM       | 1 | 2 | 3 | 4 | 5 | 6 | 7 | 8 | 9 | 10 | 11 | 12 | 13 | 14 | 15 | 16 | A  | 17 | 18 | 19 |
| 35 | 14E31A0444 | SANA BEGUM             | 1 | 2 | 3 | 4 | 5 | 6 | 7 | 8 | 9 | 10 | 11 | 12 | 13 | 14 | 15 | 16 | 17 | 18 | 19 | 20 |
| 36 | 14E31A0445 | SAPPI KARTHEK REDDY    | 1 | 2 | 3 | 4 | 5 | 6 | 7 | 8 | 9 | 10 | 11 | 12 | 13 | 14 | 15 | 16 | 17 | 18 | 19 | 20 |
| 37 | 14E31A0446 | SATHI VARUN            | 1 | A | 2 | 3 | 4 | 5 | 6 | 7 | 8 | 9  | 10 | 11 | A  | 12 | 13 | 14 | 15 | 16 | 17 | 18 |
| 38 | 14E31A0447 | SHAIK AMAIR HOSSAIN    | 1 | 2 | 3 | 4 | 5 | 6 | 7 | 8 | 9 | 10 | 11 | 12 | 13 | 14 | 15 | 16 | 17 | 18 | 19 | 20 |
| 39 | 14E31A0448 | SUNKARI SRINATH        | 1 | 2 | 3 | 4 | 5 | 6 | 7 | 8 | 9 | 10 | 11 | 12 | 13 | 14 | 15 | 16 | A  | 17 | 18 | 19 |
| 40 | 14E31A0449 | THIRPARTHI SURYA TEJA  | 1 | 2 | 3 | 4 | 5 | 6 | 7 | 8 | 9 | 10 | 11 | 12 | 13 | 14 | 15 | 16 | 17 | 18 | 19 | 20 |
| 41 | 14E31A0450 | IBANALLA DIVYA SAI     | 1 | 2 | 3 | 4 | 5 | 6 | 7 | 8 | 9 | 10 | 11 | 12 | 13 | 14 | 15 | 16 | 17 | 18 | 19 | 20 |
| 42 | 14E31A0451 | BOMMA PAVANI           | 1 | 2 | 3 | 4 | 5 | 6 | 7 | 8 | 9 | 10 | 11 | 12 | 13 | 14 | 15 | 16 | 17 | 18 | 19 | 20 |
| 43 | 14E31A0444 | P VINEETH REDDY        | 1 | 2 | 3 | 4 | 5 | 6 | 7 | 8 | 9 | 10 | 11 | 12 | 13 | 14 | 15 | 16 | 17 | 18 | 19 | 20 |
| 44 | 14E31A0420 | J N SRIJANITHA         | 1 | 2 | 3 | 4 | 5 | 6 | 7 | 8 | 9 | 10 | 11 | 12 | 13 | 14 | 15 | 16 | 17 | 18 | 19 | 20 |
| 45 | 14E31A0457 | V BHADRI TEJA          | 1 | 2 | 3 | 4 | 5 | 6 | 7 | 8 | 9 | 10 | 11 | 12 | 13 | 14 | 15 | 16 | 17 | 18 | 19 | 20 |
| 46 | 14E31A0455 | T SHASHANK KUMAR REDDY | 1 | 2 | 3 | 4 | 5 | 6 | 7 | 8 | 9 | 10 | 11 | 12 | 13 | 14 | 15 | 16 | 17 | 18 | 19 | 20 |
| 47 | 14E31A0448 | D KALYAN               | 1 | 2 | 3 | 4 | 5 | 6 | 7 | 8 | 9 | 10 | 11 | 12 | 13 | 14 | 15 | 16 | 17 | 18 | 19 | 20 |
| 48 | 14E31A0464 | AJMEERA NIKHIL         | 1 | 2 | 3 | 4 | 5 | 6 | 7 | 8 | 9 | 10 | 11 | 12 | 13 | 14 | 15 | 16 | 17 | 18 | 19 | 20 |
| 49 | 14E31A0492 | S DEEKSHIT BEJU        | 1 | 2 | 3 | 4 | 5 | 6 | 7 | 8 | 9 | 10 | 11 | 12 | 13 | 14 | 15 | 16 | 17 | 18 | 19 | 20 |
| 50 | 14E31A0440 | N JASRI PRASAD         | 1 | 2 | 3 | 4 | 5 | 6 | 7 | 8 | 9 | 10 | 11 | 12 | 13 | 14 | 15 | 16 | 17 | 18 | 19 | 20 |
| 51 | 14E31A0419 | S RAJ KUMAR            | 1 | 2 | 3 | 4 | 5 | 6 | 7 | 8 | 9 | 10 | 11 | 12 | 13 | 14 | 15 | 16 | 17 | 18 | 19 | 20 |

*[Signature]*  
HOD, ECE Dept

*[Signature]*

PRINCIPAL  
**MAHAVEER**  
INSTITUTE OF SCIENCE & TECHNOLOGY  
Banabaguda, Hyd-500 085.

*[Signature]*  
Co-ordinator

Vysapuri, Bandlaguda Post:Keshavgiri,

Hyderabad-500 005, TELANGANA INDIA  
Tel: 040-64596979,8978380692.Fax: 040-24455003  
E-mail: [c3hod.cse@gmail.com](mailto:c3hod.cse@gmail.com).  
Website: [www.mist.ac.in](http://www.mist.ac.in),

# MAHAVEER

INSTITUTE OF SCIENCE & TECHNOLOGY

Approved by AICTE, Affiliated to JNTUH,Hyd.



## DEPARTMENT OF COMPUTER SCIENCE AND ENGINEERING

Date: 03-09-2018

### CIRCULAR

Technical Trainings for III & IV B. Tech students are starting from 10-09-2018 onwards. All HODs and placements coordinators have to manage the trainings and ensure 95% attendance all through the sessions.

All mentors need to send the compiled feedback report to HOD at [c3hod@gmail.com](mailto:c3hod@gmail.com) daily. Mentors are advised to take care of PNR (Students not participating in training).

Agenda: PC Hardware and Networking

HOD CSE

PRINCIPAL  
MAHAVEER  
INSTITUTE OF SCIENCE & TECHNOLOGY  
Bandlaguda, Hyd-500 005.

Vysapuri, Bandlaguda Post:Keshavgiri,

Hyderabad-500 005, TELANGANA INDIA  
Tel: 040-64596979,8978380692.Fax: 040-24455003  
E-mail: [g3hod.cse@gmail.com](mailto:g3hod.cse@gmail.com),  
Website: [www.mist.ac.in](http://www.mist.ac.in),

# MAHAVEER

INSTITUTE OF SCIENCE & TECHNOLOGY

Approved by AICTE, Affiliated to JNTUH,Hyd.



## DEPARTMENT OF COMPUTER SCIENCE AND ENGINEERING

### SYLLABUS FOR PC Hardware and Networking

| SNO | TOPIC COVERED                                | DURATION |
|-----|--|----------|
| 1   | Introduction about computer                  | 2        |
| 2   | Basic Networking concepts                    | 6        |
| 3   | Introduction to various networking devices   | 4        |
| 4   | Inside the PC                                | 4        |
| 5   | Network basic and configuration              | 4        |
| 6   | Introduction to servers and network security | 10       |

HOD-CSE 



PRINCIPAL  
MAHAVEER  
INSTITUTE OF SCIENCE & TECHNOLOGY  
Bandlaguda, Hyderabad-500 005.



Vysapuri, Bandlaguda Post:Keshavgirl,

Hyderabad-500 005, TELANGANA INDIA  
Tel: 040-64596979,8978380692.Fax: 040-24455003  
E-mail: e3hod.cse@gmail.com,  
Website: www.mist.ac.in,

# MAHAVEER

INSTITUTE OF SCIENCE & TECHNOLOGY

Approved by AICTE, Affiliated to JNTUH,Hyd.



## DEPARTMENT OF COMPUTER SCIENCE AND ENGINEERING

### LIST OF REGISTERED STUDENTS FOR PC Hardware and Networking

| SNO | HALL TICKET NO | NAME OF THE STUDENT           |
|-----|----------------|-------------------------------|
| 1   | 14E31A0501     | ADUNUTULA VISHNU PREETH REDDY |
| 2   | 14E31A0502     | AENUGU RASAGNYA               |
| 3   | 14E31A0503     | AKULA NIHARIKA                |
| 4   | 14E31A0504     | ALLE AKHILENDRA SATYANARAYANA |
| 5   | 14E31A0505     | AMIR SOHAIL                   |
| 6   | 14E31A0507     | ANUMULA VINOD ABHISHEK        |
| 7   | 14E31A0508     | ASTAM PRANAY REDDY            |
| 8   | 14E31A0511     | CHENNAPPAGARI AISHWARYA       |
| 9   | 14E31A0513     | DONGRE JAIPAL                 |
| 10  | 14E31A0514     | EDUKOJU ANUPRIYA              |
| 11  | 14E31A0517     | GADDALAPALI SRINIVAS          |
| 12  | 14E31A0518     | GAJARLA KARUNASAGAR           |
| 13  | 14E31A0519     | GAJJALA DHRUVA MANASA         |
| 14  | 14E31A0520     | GILLA RAJESH                  |
| 15  | 14E31A0521     | YEDULAPURAM SAHITHI           |
| 16  | 14E31A0522     | GUMMALLA SAI NISHANTH REDDY   |
| 17  | 14E31A0523     | GUNUPURU ROJA RANI            |
| 18  | 14E31A0524     | ISLAVATH KISHORE              |
| 19  | 14E31A0526     | KHUSHBHU DONGARE              |
| 20  | 14E31A0527     | KULKARNI SANKIRTH             |

PRINCIPAL

*K. Suresh*  
MAHAVEER  
INSTITUTE OF SCIENCE & TECHNOLOGY  
Bandlaguda, Hyderabad-500 005.

Vysapuri, Bandlaguda Post:Keshavgiri,

Hyderabad-500 005, TELANGANA INDIA  
Tel: 040-64596979,8978380692.Fax: 040-24455003  
E-mail: [g3hod.cse@gmail.com](mailto:g3hod.cse@gmail.com),  
Website: [www.mist.ac.in](http://www.mist.ac.in),

# MAHAVEER

INSTITUTE OF SCIENCE & TECHNOLOGY

Approved by AICTE, Affiliated to JNTUH,Hyd.



## DEPARTMENT OF COMPUTER SCIENCE AND ENGINEERING

|    |            |                             |
|----|------------|-----------------------------|
| 21 | 14E31A0528 | KUNA SAI SANGEETHA          |
| 22 | 14E31A0529 | LOKANADAM DEVI              |
| 23 | 14E31A0530 | M A MUJADID MOHIUDDIN       |
| 24 | 14E31A0533 | MEDI NITHIN                 |
| 25 | 15E31A0501 | ABHISHEK KUMAR GAUTAM       |
| 26 | 15E31A0502 | AFRIN                       |
| 27 | 15E31A0503 | ALLA VANAJA CHOWDARI        |
| 28 | 15E31A0504 | AMANCHERLA GAYATHRI SUSHMA  |
| 29 | 15E31A0505 | ANNARAPU KSHETHRA           |
| 30 | 15E31A0506 | ARVA SHASHANK               |
| 31 | 15E31A0507 | BADAM SHARATH KUMAR         |
| 32 | 15E31A0508 | BAGGARI SIVA NARAYANA REDDY |
| 33 | 15E31A0509 | BEJAVADA KRISHNA SAI        |
| 34 | 15E31A0510 | BELUGUPPA H S LAHARI        |
| 35 | 15E31A0512 | BUNNE VAMSHI KRISHNA        |
| 36 | 15E31A0514 | CHITTIMALLA SAIRAM          |
| 37 | 15E31A0515 | D ESHWAR PRASAD             |
| 38 | 15E31A0516 | DHYADE SHAILAJA             |
| 39 | 15E31A0517 | DIDYALA KIRAN KUMAR         |
| 40 | 15E31A0518 | NAKKA CHAITANYA             |
| 41 | 15E31A0519 | G MAHESHWARI                |

*Kshudh*

PRINCIPAL

M. V. S. R.  
MAHAVEER INSTITUTE OF SCIENCE & TECHNOLOGY  
Bandlaguda, Hyd-500 005

Vysapuri, Bandlaguda Post:Keshavgiri,

Hyderabad-500 005, TELANGANA INDIA  
Tel: 040-64596979,8978380692. Fax: 040-24455003  
E-mail: [e3hod.cse@gmail.com](mailto:e3hod.cse@gmail.com),  
Website: [www.mist.ac.in](http://www.mist.ac.in),

# MAHAVEER

INSTITUTE OF MULTIMEDIA & TECHNOLOGY  
Approved by AICTE, Affiliated to JNTUH,Hyd



## DEPARTMENT OF COMPUTER SCIENCE AND ENGINEERING

|    |            |                          |
|----|------------|--------------------------|
| 42 | 15E31A0520 | GOUKAR SUSHMA            |
| 43 | 15E31A0521 | GUDURU SANKEERTH         |
| 44 | 15E31A0523 | GURRAM RAJESH            |
| 45 | 15E31A0527 | KARIGIRI RAMYA           |
| 46 | 15E31A0528 | KOMANDLA ANILA REDDY     |
| 47 | 15E31A0530 | L NAVYATHA               |
| 48 | 15E31A0531 | M VARUN KUMAR REDDY      |
| 49 | 15E31A0537 | NAGUBANDI SAIRAM PRUDHVI |
| 50 | 15E31A0542 | NIMMALA VINAYKUMAR       |
| 51 | 15E31A0543 | NITISH REDDY K           |
| 52 | 15E31A0544 | P VAMSHI KRISHNA         |
| 53 | 15E31A0545 | PAYAPULA MAHENDAR        |
| 54 | 15E31A0546 | PINJALA DHANRAJ SAGAR    |

*[Handwritten Signature]*

PRINCIPAL  
MAHAVEER INSTITUTE OF MULTIMEDIA & TECHNOLOGY  
Bandlaguda, Hyd-500 005.



Vysapuri, Bandlaguda Post:Keshavgiri,

Hyderabad-500 005, TELANGANA INDIA  
Tel: 040-64596979,8978380692,Fax: 040-24455003  
E-mail: [e3hod.cse@gmail.com](mailto:e3hod.cse@gmail.com),  
Website: [www.mist.ac.in](http://www.mist.ac.in),

# MAHAVEER

INSTITUTE OF SCIENCE & TECHNOLOGY

Approved by AICTE, Affiliated to JNTUH,Hyd.



## DEPARTMENT OF COMPUTER SCIENCE AND ENGINEERING

### PC Hardware and Networking QUESTION PAPER

Duration: 120 Minutes

10 X 2 = 20 Marks

Answer the following all questions. Each question carries 2 marks.

1. What Is A Computer?
2. What Are The Different Functions Of A Computer?
3. How A Minicomputer Different From A Mainframe?
4. What Is Super Computer?
5. Differentiate Input and Output Device?
6. What Is A Storage Device? What Is The Common Classification?
7. What Do You Mean By A Processing Device? What Are The Various Types Of Processing Devices?
8. What Is An Interface?
9. What is a network?
10. What are the different types of networks?

  
HOD-CSE

  
PRINCIPAL  
MAHAVEER  
INSTITUTE OF SCIENCE & TECHNOLOGY  
Bandlaguda, Hyd-500 005.

Vysapuri, Bandlaguda Post:Keshavgiri,

Hyderabad-500 005, TELANGANA INDIA

Tel: 040-64596979,8978380692.Fax: 040-24455003

E-mail: e3hod.cse@gmail.com,

Website: www.mist.ac.in,

# MAHAVEER

INSTITUTE OF ENGINEERING & TECHNOLOGY

Approved by AICTE, Affiliated to JNTUH,Hyd.



## DEPARTMENT OF COMPUTER SCIENCE AND ENGINEERING

### RESULT SHEET PC Hardware and Networking REGISTERED STUDENTS

| SNO | HALL TICKET NO | NAME OF THE STUDENT              | MARKS (20) | RESULT |
|-----|----------------|----------------------------------|------------|--------|
| 1   | 14E31A0501     | ADUNUTULA VISHNU PREETH<br>REDDY | 20         | PASS   |
| 2   | 14E31A0502     | AENUGU RASAGNYA                  | 19         | PASS   |
| 3   | 14E31A0503     | AKULA NIHARIKA                   | 20         | PASS   |
| 4   | 14E31A0504     | ALLE AKHILENDRA<br>SATYANARAYANA | 18         | PASS   |
| 5   | 14E31A0505     | AMIR SOHAIL                      | 20         | PASS   |
| 6   | 14E31A0507     | ANUMULA VINOD ABHISHEK           | 20         | PASS   |
| 7   | 14E31A0508     | ASTAM PRANAY REDDY               | 16         | PASS   |
| 8   | 14E31A0511     | CHENNAPPAGARI AISHWARYA          | 20         | PASS   |
| 9   | 14E31A0513     | DONGRE JAIPAL                    | 20         | PASS   |
| 10  | 14E31A0514     | EDUKOJU ANUPRIYA                 | 17         | PASS   |
| 11  | 14E31A0517     | GADDALAPALLI SRINIVAS            | 20         | PASS   |
| 12  | 14E31A0518     | GAJARLA KARUNASAGAR              | 20         | PASS   |
| 13  | 14E31A0519     | GAJALA DHRUVA MANASA             | 16         | PASS   |
| 14  | 14E31A0520     | GILLA RAJESH                     | 20         | PASS   |
| 15  | 14E31A0521     | YEDULAPURAM SAHITHI              | 20         | PASS   |
| 16  | 14E31A0522     | GUMMALLA SAI NISHANTH REDDY      | 18         | PASS   |
| 17  | 14E31A0523     | GUNUPURU ROJA RANI               | 20         | PASS   |
| 18  | 14E31A0524     | ISLAVATH KISHORE                 | 19         | PASS   |
| 19  | 14E31A0526     | KHUSHBHU DONGARE                 | 20         | PASS   |

*K. Srinivas*  
PRINCIPAL

MAHAVEER  
INSTITUTE OF ENGINEERING & TECHNOLOGY  
Bandlaguda Post, Hyderabad-500 005

Vysapuri, Bandlaguda Post:Keshavgiri,

Hyderabad-500 005, TELANGANA INDIA  
Tel: 040-64596979,8978380692.Fax: 040-24455003  
E-mail: [e3hod.cse@gmail.com](mailto:e3hod.cse@gmail.com),  
Website: [www.mist.ac.in](http://www.mist.ac.in),

# MAHAVEER

INSTITUTE OF SCIENCE & TECHNOLOGY

Approved by AICTE, Affiliated to JNTUH,Hyd.



## DEPARTMENT OF COMPUTER SCIENCE AND ENGINEERING

|    |            |                             |    |      |
|----|------------|-----------------------------|----|------|
| 20 | 14E31A0527 | KULKARNI SANKIRTH           | 18 | PASS |
| 21 | 14E31A0528 | KUNA SAI SANGEETHA          | 20 | PASS |
| 22 | 14E31A0529 | LOKANADAM DEVI              | 20 | PASS |
| 23 | 14E31A0530 | M A MUJADID MOHIUDDIN       | 16 | PASS |
| 24 | 14E31A0533 | MEDI NITHIN                 | 20 | PASS |
| 25 | 15E31A0501 | ABHISHEK KUMAR GAUTAM       | 20 | PASS |
| 26 | 15E31A0502 | AFRIN                       | 20 | PASS |
| 27 | 15E31A0503 | ALLA VANAJA CHOWDARI        | 18 | PASS |
| 28 | 15E31A0504 | AMANCHERLA GAYATHRI SUSHMA  | 19 | PASS |
| 29 | 15E31A0505 | ANNARAPU KSHETHRA           | 20 | PASS |
| 30 | 15E31A0506 | ARVA SHASHANK               | 18 | PASS |
| 31 | 15E31A0507 | BADAM SHARATH KUMAR         | 17 | PASS |
| 32 | 15E31A0508 | BAGGARI SIVA NARAYANA REDDY | 20 | PASS |
| 33 | 15E31A0509 | BEJAVADA KRISHNA SAI        | 19 | PASS |
| 34 | 15E31A0510 | BELUGUPPA H S LAHARI        | 20 | PASS |
| 35 | 15E31A0512 | BUNNE VAMSHI KRISHNA        | 18 | PASS |
| 36 | 15E31A0514 | CHITTIMALLA SAIRAM          | 20 | PASS |
| 37 | 15E31A0515 | D ESHWAR PRASAD             | 20 | PASS |
| 38 | 15E31A0516 | DHYADE SHAILAJA             | 16 | PASS |
| 39 | 15E31A0517 | DIDYALA KIRAN KUMAR         | 20 | PASS |
| 40 | 15E31A0518 | NAKKA CHAITANYA             | 20 | PASS |

*K. Babu*

PRINCIPAL  
MAHAVEER  
INSTITUTE OF SCIENCE & TECHNOLOGY  
Bandlaguda, Hyderabad-500 005.



Vysapuri, Bandlaguda Post:Keshavgiri,

# MAHAVEER

INSTITUTE OF SCIENCE & TECHNOLOGY

Approved by AICTE, Affiliated to JNTUH, Hyd.



Hyderabad-500 005, TELANGANA INDIA

Tel: 040-64596979,8978380692, Fax: 040-24455003

E-mail: [e3hod.cse@gmail.com](mailto:e3hod.cse@gmail.com),

Website: [www.mist.ac.in](http://www.mist.ac.in),

## DEPARTMENT OF COMPUTER SCIENCE AND ENGINEERING

|    |            |                          |    |      |
|----|------------|--------------------------|----|------|
| 41 | 15E31A0519 | G MAHESHWARI             | 17 | PASS |
| 42 | 15E31A0520 | GOULIKAR SUSHMA          | 20 | PASS |
| 43 | 15E31A0521 | GUDURU SANKEERTH         | 20 | PASS |
| 44 | 15E31A0523 | GURRAM RAJESH            | 16 | PASS |
| 45 | 15E31A0527 | KARIGIRI RAMYA           | 20 | PASS |
| 46 | 15E31A0528 | KOMANDLA ANILA REDDY     | 20 | PASS |
| 47 | 15E31A0530 | L NAVYATHA               | 18 | PASS |
| 48 | 15E31A0531 | M VARUN KUMAR REDDY      | 20 | PASS |
| 49 | 15E31A0537 | NAGUBANDI SAIRAM PRUDHVI | 19 | PASS |
| 50 | 15E31A0542 | NIMMALA VINAYKUMAR       | 20 | PASS |
| 51 | 15E31A0543 | NITISH REDDY K           | 18 | PASS |
| 52 | 15E31A0544 | P VAMSHI KRISHNA         | 20 | PASS |
| 53 | 15E31A0545 | PAYAPULA MAHENDAR        | 20 | PASS |
| 54 | 15E31A0546 | PINJALA DHANRAJ SAGAR    | 16 | PASS |

No. of students Registered:54

No. of students Passed:54

No. of students failed:NIL

*Khandy*  
PRINCIPAL  
MAHAVEER  
INSTITUTE OF SCIENCE & TECHNOLOGY  
Bandlaguda, Hyd-500 005.

Vysapuri, Bandlaguda Post:Keshavgiri,

Hyderabad-500 005, TELANGANA INDIA  
Tel: 040-64596979,8978380692,Fax: 040-24455003  
E-mail: [e3hod,cse@gmail.com](mailto:e3hod,cse@gmail.com),  
Website: [www.mist.ac.in](http://www.mist.ac.in),

# MAHAVEER

INSTITUTE OF SCIENCE & TECHNOLOGY  
Approved by AICTE, Affiliated to JNTUH,Hyd.



## DEPARTMENT OF COMPUTER SCIENCE AND ENGINEERING

### SUMMARY REPORT OF PC Hardware and Networking

- Computer Hardware is the combination of physical components or parts that makes the computer system. Physical components include **monitor, keyboard, mouse, hard disk drive, graphic card, RAM, motherboard**, etc.
- Networking is the field of computer science that allows computers to exchange data or information.

COORDINATOR

Copy to:

1. Department Notice Board
2. Principal for Information
3. Committee Members (Academic)

*U. Srinivas*  
PRINCIPAL  
MAHAVEER  
INSTITUTE OF SCIENCE & TECHNOLOGY  
BANDLAGUDA, HYD-500 005.

Vysapuri, Bandlaguda Post:Keshavgiri,

Hyderabad-500 005, TELANGANA INDIA  
Tel: 040-64596979,8978380692 Fax: 040-24455003  
E-mail: [s3hod.it@gmail.com](mailto:s3hod.it@gmail.com),  
Website: [www.miat.ac.in](http://www.miat.ac.in),

# MAHAVEER

INSTITUTE OF SCIENCE & TECHNOLOGY

Approved by AICTE, Affiliated to JNTUH,Hyd.



## DEPARTMENT OF INFORMATION TECHNOLOGY

Date:25-01-2017

To,

The principal,  
MIST,  
Hyderabad.

Sub: Proposal for Add-on Course-Reg.

Dear Sir,

We are going to conduct two weeks workshop on **Technical Training MS-Office**. We require your approval to go head for further proceeding and hope to get an opportunity to serve you the best.

With thanks and Regards

*Kshy*  
MAHAVEER  
INSTITUTE OF SCIENCE & TECHNOLOGY  
Bandlaguda, Hyd-500 005.



Vysapuri, Bandlaguda Post:Keshavgiri,

Hyderabad-500 005, TELANGANA INDIA  
Tel: 040-64596979,8978380692,Fax: 040-24455003  
E-mail: [e3hod.ii@gmail.com](mailto:e3hod.ii@gmail.com),  
Website: [www.mist.ac.in](http://www.mist.ac.in),

# MAHAVEER

INSTITUTE OF SCIENCE & TECHNOLOGY

Approved by AICTE. Affiliated to JNTUH,Hyd.



## DEPARTMENT OF INFORMATION TECHNOLOGY

Date: 01-02-2017

### CIRCULAR

Technical Trainings for III & IV B. Tech students are starting from 06-02-2017 onwards. All HODs and placements coordinators have to manage the trainings and ensure 95% attendance all through the sessions.

All mentors need to send the compiled feedback report to HOD at [e3hod@gmail.com](mailto:e3hod@gmail.com) daily. Mentors are advised to take care of PNR (Students not participating in training).

Agenda: Technical Training MS-Office

**Design and Development of Curriculum for Add on Course:**

Name of the Faculty: 1.CH B NAGALAKSHMI  
2.A.NANDA GOPAL REDDY  
3.KBVK NAGA SREE

  
HOD



Principal  
MAHAVEER  
INSTITUTE OF SCIENCE & TECHNOLOGY  
Bandlaguda, Hyd-500 005.

Vysapuri, Bandlaguda Post, Keshavnagar,

Hyderabad-500 005, TELANGANA INDIA  
Tel: 040-64506970, 8978388692. Fax: 040-24455003  
E-mail: [edhod.it@gmail.com](mailto:edhod.it@gmail.com).  
Website: [www.mist.ac.in](http://www.mist.ac.in).

# MAHAVEER

INSTITUTE OF STUDIES & TECHNOLOGY  
Approved by AICTE, Affiliated to JNTUH, Hyd.



## DEPARTMENT OF INFORMATION TECHNOLOGY

### SYLLABUS FOR Technical Training MS-Office

| SNO | TOPIC COVERED  | DURATION |
|-----|--|----------|
| 1   | Ms. word : Creating, editing, saving and printing text documents - | 3        |
| 2   | Inserting tables, smart art, page breaks                           | 3        |
| 3   | Using lists and styles   | 3        |
| 4   | Working with images  | 3        |
| 5   | Using Spelling and Grammar check                                   | 3        |
| 6   | Mail Merge   | 3        |
| 7   | Ms. Excel: Spreadsheet basics                                      | 3        |
| 8   | Creating, editing, saving and printing spreadsheets                | 3        |
| 9   | Working with functions & formulas                                  | 3        |
| 10  | Graphically representing data : Charts & Graphs                    | 3        |
| 11  | Speeding data entry : Using Data Forms                             | 3        |
| 12  | Analyzing data : Data Menu, Subtotal, Filtering Data               | 3        |
| 13  | Ms. Power Point : Opening, viewing, creating, and printing slides  | 3        |
| 14  | Applying auto layouts  | 3        |
| 15  | Adding custom animation  | 3        |
| 16  | Using slide transitions  | 3        |
| 17  | Creating Professional Slide for Presentation.                      | 3        |

*(Handwritten signature)*  
MIST-II

*Subj*  
MAHAVEER  
INSTITUTE OF STUDIES & TECHNOLOGY  
Bandlaguda, Hyd-500 005.

Vysapuri, Bandlaguda Post Keshavnagar,

# MAHAVEER



Hyderabad-500 005, TELANGANA INDIA  
Tel: 040-64596979,8978380692.Fax: 040-24455003  
E-mail: e3hotl.it@gmail.com,  
Website: www.mist.ac.in

Approved by AICTE. Affiliated to JNTUH Hyd

## DEPARTMENT OF INFORMATION TECHNOLOGY

### LIST OF REGISTERED STUDENTS FOR Technical Training MS-Office

| SNO | HALL TICKET NO | NAME OF THE STUDENT        |
|-----|----------------|----------------------------|
| 1   | 13E31A1201     | AKKINEPALLY SPANDANA       |
| 2   | 13E31A1202     | BADDAM RAJ KUMAR           |
| 3   | 13E31A1203     | BURUGU DEEPA               |
| 4   | 13E31A1204     | CHETHI REDDY ARAVIND REDDY |
| 5   | 13E31A1207     | T. KARUNAKAR               |
| 6   | 14E31A1202     | AREKATLA DIVYA             |
| 7   | 14E31A1204     | B SAI KIRAN REDDY          |
| 8   | 14E31A1205     | BANDHYALA AKSHAY REDDY     |
| 9   | 14E31A1206     | DEVARANENI SRAVANI         |
| 10  | 14E31A1208     | GANGIDI ANUSHA             |
| 11  | 14E31A1209     | GANTE SANTHOSH             |
| 12  | 14E31A1210     | GUJJA SAI AKHIL            |
| 13  | 14E31A1211     | KAVETI LALANI              |
| 14  | 14E31A1212     | KORASIKA SAI KIRAN         |
| 15  | 14E31A1214     | KURNAMONI DILIP            |
| 16  | 14E31A1215     | MAHENDER SINGH             |
| 17  | 14E31A1216     | MAMIDIPALLY MOUNIKA        |
| 18  | 14E31A1218     | NALIMELA VINAY REDDY       |
| 19  | 14E31A1220     | NARAGONI SHIVA VENKATA SAI |
| 20  | 14E31A1221     | PRANATHI PADAKANTI         |
| 21  | 14E31A1222     | RAMA RAKESH                |
| 22  | 14E31A1223     | RAMIDI KAVYA REDDY         |
| 23  | 14E31A1224     | SREERAMINENI SRUJANA       |
| 24  | 14E31A1225     | THIPPARAPU SRIVANI         |
| 25  | 14E31A1227     | VEERAMREDDY MANASA         |

*Kanika*  
OFFICIAL  
MAHAVEER  
INSTITUTE OF TECHNOLOGY & MANAGEMENT  
Bandlaguda, Hyderabad-500 005.



Bangalore, Bandlaguda Post, Keshavnagar,

Hyderabad-500 005, TELANGANA INDIA  
Tel: 040-64530979, 8978380692 Fax: 040-24455003  
E-mail: a2hod.ii@gmail.com  
Website: www.mist.ac.in,

# MAHAVEER

INSTITUTE OF DESIGN & TECHNOLOGY  
Approved by AICTE. Affiliated to JNTU(H) Hyd.



## DEPARTMENT OF INFORMATION TECHNOLOGY

### Technical Training MS-Office QUESTION PAPER

Duration: 120 Minutes

20 X 1 = 20 Marks

Answer the following all questions. Each question carries 1 mark.

1. How to add first-page & end note in word?
2. What is the shortcut keys for creating hyperlink?
3. How you can insert an online picture in your word document in word 2013?
4. How you can create a custom watermark?
5. What is the shortcut key to insert a page break?
6. What is Microsoft Excel?
7. How can you add cells, rows or columns in Excel?
8. How would you format a cell? What are the options?
9. What are charts in MS Excel?
10. What is Freeze Panes in MS-Excel?
11. Is it possible to make Pivot table using multiple sources of data?
12. What are the advantages of using formula in Excel sheet?
13. What is a Macro in Excel? How to create an Excel Macro?
14. How can you show your presentation online in PowerPoint?
15. How you can record a slide show in PowerPoint?
16. Can we make PowerPoint slides into PDF files in PowerPoint?
17. How you can convert text to shapes in PowerPoint?
18. How to customize your slide PowerPoint?
19. How you can protect your presentation in PowerPoint?
20. How you can customize slide layout?

*K. Srinivas*

PROFESSOR  
MAHAVEER  
INSTITUTE OF DESIGN & TECHNOLOGY  
Bandlaguda, Hyd-500 005.

*A. Srinivas*  
APP-DT

Head of Department

MAHAVEER INSTITUTE OF DESIGN & TECHNOLOGY

Bandlaguda, Hyd-500 005.

Vysapuri, Bandlaguda Post: Keshavgi, Hyderabad-500 005, TELANGANA INDIA

Tel: 040-64506979, 6978380692 Fax: 040-24455003  
E-mail: [ejhodit@gmail.com](mailto:ejhodit@gmail.com)  
Website: [www.mist.ac.in](http://www.mist.ac.in)

# MAHAVEER

INSTITUTE OF SCIENCE & TECHNOLOGY

Approved by AICTE, Affiliated to JNTUH, Hyd.



## DEPARTMENT OF INFORMATION TECHNOLOGY

### RESULT SHEET FOR Technical Training MS-Office REGISTERED STUDENTS

| SNO | HALL TICKET NO | NAME OF THE STUDENT         | MARKS (00) | RESULT |
|-----|----------------|-----------------------------|------------|--------|
| 1   | 13E31A1201     | AKKINEPALLY SPANDANA        | 20         | PASS   |
| 2   | 13E31A1202     | BADDAM RAI KUMAR            | 19         | PASS   |
| 3   | 13E31A1203     | BURUGU DEEPA                | 20         | PASS   |
| 4   | 13E31A1204     | CHEITHI REDDY ARAVIND REDDY | 14         | PASS   |
| 5   | 13E31A1207     | T KARUNAKAR                 | 20         | PASS   |
| 6   | 14E31A1202     | AREKATLA DIVYA              | 20         | PASS   |
| 7   | 14E31A1204     | B SAI KIRAN REDDY           | 19         | PASS   |
| 8   | 14E31A1205     | BANDHYALA AISHAY REDDY      | 20         | PASS   |
| 9   | 14E31A1206     | DEVARANENI SRAVANI          | 19         | PASS   |
| 10  | 14E31A1208     | GANGIDI ANUSHA              | 20         | PASS   |
| 11  | 14E31A1209     | GANTE SANTHOSH              | 20         | PASS   |
| 12  | 14E31A1210     | GUJJA SAI AKHIL             | 16         | PASS   |
| 13  | 14E31A1211     | KAVETI LALANI               | 20         | PASS   |
| 14  | 14E31A1212     | KORASIKA SAI KIRAN          | 20         | PASS   |
| 15  | 14E31A1214     | KURNAMONI DILIP             | 17         | PASS   |
| 16  | 14E31A1215     | MAHENDER SINGH              | 20         | PASS   |
| 17  | 14E31A1216     | MAMIDIPALLY MOUNIKA         | 20         | PASS   |
| 18  | 14E31A1218     | NALIMELA VINAY REDDY        | 14         | PASS   |
| 19  | 14E31A1220     | NARAGONI SHIVA VENKATA SAI  | 21         | PASS   |
| 20  | 14E31A1221     | PRANATHI PADAKANTI          | 20         | PASS   |
| 21  | 14E31A1222     | RAMA RAKESH                 | 18         | PASS   |
| 22  | 14E31A1223     | RAMIDI KAVYA REDDY          | 20         | PASS   |
| 23  | 14E31A1224     | SREERAMINENI SRUJANA        | 19         | PASS   |
| 24  | 14E31A1225     | THIPPARAPU SRIVANI          | 20         | PASS   |
| 25  | 14E31A1227     | VEERAMREDDY MANASA          | 18         | PASS   |

No. of students Registered: 25

No. of students Passed: 25

No. of students failed: NIL

*Keshavgi*  
PRINCIPAL  
MAHAVEER  
INSTITUTE OF SCIENCE & TECHNOLOGY  
Bandlaguda, Hyd-500 005

Vysapuri, Bandlaguda Post, Keshavnagar,

Hyderabad-500 005, TELANGANA INDIA  
Tel: 040-64596979, 8978380092 Fax: 040-24455003  
E-mail: [ezhod.it@gmail.com](mailto:ezhod.it@gmail.com),  
Website: [www.mist.ac.in](http://www.mist.ac.in),

# MAHAVEER

INSTITUTE OF SCIENCE & TECHNOLOGY  
Approved by AICTE. Affiliated to JNTUH, Hyd



## DEPARTMENT OF INFORMATION TECHNOLOGY

### SUMMARY REPORT OF Technical Training MS-Office

The purpose of the **MS Word** is to allow the users to type and save documents. ...

Microsoft **word** is used to save documents.

The documents can be copied to flash drive which serves as an external memory for your computer.

This allows you to use the saved documents conveniently taking with you anywhere.

**MS Excel** is a spreadsheet programme developed by Microsoft in 1985, with the sole purpose of helping businesses compile all their financial data, yearly credit, and yearly debit sheets.

Fast forward to the future after 31 years, it is now the most commonly used program for creating graphs and pivot tables.

Making your presentation more interesting through the use of multimedia can help to improve the audience's focus.

**PowerPoint** allows you to use images, audio and video to have a greater visual impact.

These visual and audio cues may also help a presenter be more improvisational and interactive with the audience.

  
COORDINATOR

Copy to:

1. Department Notice Board
2. Principal for Information
3. Committee Members (Academic)

  
PRINCIPAL  
MAHAVEER  
INSTITUTE OF SCIENCE & TECHNOLOGY  
Bandlaguda, Hyd-500 005



MAHAVEEER INSTITUTE OF SCIENCE & TECHNOLOGY  
 DEPARTMENT OF INFORMATION TECHNOLOGY  
 Technical Training MS-Office ATTENDANCE SHEET

| SNO | NO         | NAME OF THE STUDENT        | Date |   |   |   |    |    |    |    |    |    |    |    |    |   |   |
|-----|------------|----------------------------|------|---|---|---|----|----|----|----|----|----|----|----|----|---|---|
|     |            |                            | 6    | 7 | 8 | 9 | 10 | 11 | 12 | 13 | 14 | 15 | 16 | 17 | 18 |   |   |
| 1   | 13E31A1201 | ASKINEPALLY SPANDANA       | P    | P | P | P | P  | P  | P  | P  | P  | P  | P  | P  | P  | P | P |
| 2   | 13E31A1202 | BADDAM RAJ KUMAR           | P    | P | P | P | P  | P  | P  | P  | P  | P  | P  | P  | P  | P | P |
| 3   | 13E31A1203 | BURUGU DEEPA               | P    | P | P | P | P  | P  | P  | P  | P  | P  | P  | P  | P  | P | P |
| 4   | 13E31A1204 | CHETHIREDDY ARAVIND REDDY  | P    | P | P | P | P  | P  | P  | P  | P  | P  | P  | P  | P  | P | P |
| 5   | 13E31A1207 | T.KARUNAKAR                | P    | P | P | P | P  | P  | P  | P  | P  | P  | P  | P  | P  | P | P |
| 6   | 14E31A1202 | AREKATLA DIVYA             | P    | P | P | P | P  | P  | P  | P  | P  | P  | P  | P  | P  | P | P |
| 7   | 14E31A1204 | B.SAIKIRAN REDDY           | P    | P | P | P | P  | P  | P  | P  | P  | P  | P  | P  | P  | P | P |
| 8   | 14E31A1205 | BANDHYALA AKSHAY REDDY     | P    | P | P | P | P  | P  | P  | P  | P  | P  | P  | P  | P  | P | P |
| 9   | 14E31A1206 | DEVARASENI SRAVANI         | P    | P | P | P | P  | P  | P  | P  | P  | P  | P  | P  | P  | P | P |
| 10  | 14E31A1208 | GIANGIDIANUSHA             | P    | P | P | P | P  | P  | P  | P  | P  | P  | P  | P  | P  | P | P |
| 11  | 14E31A1209 | GANTE SANTHOSH             | P    | P | P | P | P  | P  | P  | P  | P  | P  | P  | P  | P  | P | P |
| 12  | 14E31A1210 | GUJA SAI AKHIL             | P    | P | P | P | P  | P  | P  | P  | P  | P  | P  | P  | P  | P | P |
| 13  | 14E31A1211 | KAVETTLALANI               | P    | P | P | P | P  | P  | P  | P  | P  | P  | P  | P  | P  | P | P |
| 14  | 14E31A1212 | KORASIKA SAI KIRAN         | P    | P | P | P | P  | P  | P  | P  | P  | P  | P  | P  | P  | P | P |
| 15  | 14E31A1214 | KURNAMONI DILIP            | P    | P | P | P | P  | P  | P  | P  | P  | P  | P  | P  | P  | P | P |
| 16  | 14E31A1215 | MAHENDER SINGH             | P    | P | P | P | P  | P  | P  | P  | P  | P  | P  | P  | P  | P | P |
| 17  | 14E31A1216 | MAMIDIPALLY MOUNIKA        | P    | P | P | P | P  | P  | P  | P  | P  | P  | P  | P  | P  | P | P |
| 18  | 14E31A1218 | NALAMELA VINAY REDDY       | P    | P | P | P | P  | P  | P  | P  | P  | P  | P  | P  | P  | P | P |
| 19  | 14E31A1220 | NARAGONI SHIVA VENKATA SAI | P    | P | P | P | P  | P  | P  | P  | P  | P  | P  | P  | P  | P | P |
| 20  | 14E31A1221 | PRANATHI PADAKANTI         | P    | P | P | P | P  | P  | P  | P  | P  | P  | P  | P  | P  | P | P |
| 21  | 14E31A1222 | RAMA RAKESH                | P    | P | P | P | P  | P  | P  | P  | P  | P  | P  | P  | P  | P | P |
| 22  | 14E31A1223 | RAMIDI KAVYA REDDY         | P    | P | P | P | P  | P  | P  | P  | P  | P  | P  | P  | P  | P | P |
| 23  | 14E31A1224 | SREERAMINI SROJANA         | P    | P | P | P | P  | P  | P  | P  | P  | P  | P  | P  | P  | P | P |
| 24  | 14E31A1225 | THIPPAPARAPU SRIVANI       | P    | P | P | P | P  | P  | P  | P  | P  | P  | P  | P  | P  | P | P |
| 25  | 14E31A1227 | VEERAMREDDY MANASA         | P    | P | P | P | P  | P  | P  | P  | P  | P  | P  | P  | P  | P | P |

Signature of the Faculty

PRINCIPAL

MAHAVEEER  
 INSTITUTE OF SCIENCE & TECHNOLOGY  
 Technological Park, Hyderabad-500 005.

*(Handwritten Signature)*

Vysaveri, Bandlaguda Post:Keshavnagar,

Hyderabad-500 005, TELANGANA INDIA  
Tel: 040-64596979,8978380692 Fax: 040-24455003  
E-mail: e3hod.it@gmail.com  
Website: www.mist.ac.in.

# MAHAVEER

INSTITUTE OF SCIENCE & TECHNOLOGY

Approved by AICTE, Affiliated to JNTUH-Hyd.



## DEPARTMENT OF INFORMATION TECHNOLOGY

Date: 25-07-2016

To,

The principal,  
MIST,  
Hyderabad.

Sub: Proposal for Add-on Course-Reg.

Dear Sir,

We are going to conduct two weeks workshop on Cloud computing with HADOOP FRAMEWORK. We require your approval to go head for further proceeding and hope to get an opportunity to serve you the best.

With thanks and Regards

  
HOD

Head of Department

Department of Information Technology  
Mahaveer Institute of Science & Technology



PRINCIPAL  
MAHAVEER  
INSTITUTE OF SCIENCE & TECHNOLOGY  
Bandlaguda, Hyd-500 005

Vysapuri, Bandlaguda Post:Keshavgiri,

Hyderabad-500 005, TELANGANA INDIA  
Tel: 040-64596979,8978380692 Fax: 040-24455003  
E-mail: [e3hod.it@gmail.com](mailto:e3hod.it@gmail.com),  
Website: [www.mist.ac.in](http://www.mist.ac.in),

# MAHAVEER

INSTITUTE OF SCIENCE & TECHNOLOGY

Approved by AICTE. Affiliated to JNTUH,Hyd.



## DEPARTMENT OF INFORMATION TECHNOLOGY

Date: 01-08-2016

### CIRCULAR

Technical Trainings for II & IV B. Tech students are starting from **15-08-2016** onwards. All HODs and placements coordinators have to manage the trainings and ensure 95% attendance all through the sessions.

All mentors need to send the compiled feedback report to HOD at [e3hod@gmail.com](mailto:e3hod@gmail.com) daily. Mentors are advised to take care of PNR (Students not participating in training).

Agenda: Cloud computing with HADOOP FRAMEWORK

### Design and Development of Curriculum for Add on Course:

Name of the Faculty: 1.CH B NAGALAKSHMI  
2.S.SRINIVAS  
3.V NARESH KUMAR REDDY

*[Handwritten Signature]*  
HOD

*[Handwritten Signature]*  
PRINCIPAL  
MAHAVEER  
INSTITUTE OF SCIENCE & TECHNOLOGY  
Bandlaguda, Hyderabad-500 005



Vysapuri, Banilaguda Post, Keshavnagar,

Hyderabad-500 005, TELANGANA INDIA  
Tel: 040-64596979, 8970380502 Fax: 040-24455003  
E-mail: [edhod.it@gmail.com](mailto:edhod.it@gmail.com)  
Website: [www.mist.ac.in](http://www.mist.ac.in)

# MAHAVEER

INSTITUTE OF SCIENCE & TECHNOLOGY

Approved by AICTE, Affiliated to JNTUH, Hyd.



## DEPARTMENT OF INFORMATION TECHNOLOGY

### SYLLABUS FOR Cloud computing with HADOOP FRAMEWORK

| SNO | TOPIC COVERED                                   | DURATION |
|-----|---|----------|
| 1   | Introduction to Cloud Computing                 | 3        |
| 2   | Adopting the Cloud                              | 3        |
| 3   | Exploiting Software as a Service (SaaS)         | 3        |
| 4   | Delivering Platform as a Service (PaaS)         | 3        |
| 5   | Deploying Infrastructure as a Service (IaaS)    | 3        |
| 6   | Building a Business Case                        | 3        |
| 7   | Migrating to the Cloud                          | 3        |
| 8   | Introduction to Hadoop                          | 3        |
| 9   | Hadoop Architecture, Distributed Storage & YARN | 3        |
| 10  | Data Ingestion into Big Data Systems            | 3        |
| 11  | Distributed Processing                          | 3        |
| 12  | Apache Hive                                     | 3        |
| 13  | NoSQL Data bases-HBase                          | 3        |

*Principals*  
C.D-IT

*Kanthy*  
PRINCIPAL  
MAHAVEER  
INSTITUTE OF SCIENCE & TECHNOLOGY  
Banilaguda, Hyd-500 005.

**DEPARTMENT OF INFORMATION TECHNOLOGY****LIST OF REGISTERED STUDENTS FOR Cloud computing with HADOOP FRAMEWORK**

| SNO | HALL TICKET NO | NAME OF THE STUDENT        |
|-----|----------------|----------------------------|
| 1   | 13E31A1201     | AKKINEPALLY SPANDANA       |
| 2   | 13E31A1202     | BADDAM RAJ KUMAR           |
| 3   | 13E31A1203     | BURUGU DEEPA               |
| 4   | 13E31A1204     | CHETHI REDDY ARAVIND REDDY |
| 5   | 13E31A1207     | T KARUNAKAR                |
| 6   | 15E31A1202     | AMAN SINGH BADYAL          |
| 7   | 15E31A1203     | ARUTLA RAJ GOPAL           |
| 8   | 15E31A1204     | BALLA UPENDRA              |
| 9   | 15E31A1205     | BALMOORI SAHITHI           |
| 10  | 15E31A1206     | CHATLA NIKHIL KUMAR        |
| 11  | 15E31A1207     | D KRISHNA SRI              |
| 12  | 15E31A1208     | D LAXMI SAROJA             |
| 13  | 15E31A1209     | DORAGARI NIKHITHA          |
| 14  | 15E31A1210     | DUMALA VENU                |
| 15  | 15E31A1211     | GANDHASIRI BHARATH KUMAR   |
| 16  | 15E31A1212     | GUNNALA SIRISHA            |
| 17  | 15E31A1213     | K RASHMITHA                |
| 18  | 15E31A1214     | KALIGOTA VIGNESH REDDY     |
| 19  | 15E31A1215     | KAPARTHI SRIVARDHAN        |

*Kanthy*  
 PRINCIPAL  
**MAHAVEER**  
 INSTITUTE OF SCIENCE & TECHNOLOGY  
 Bandlaguda, Hyderabad-508 005

Vysapuri, Bandlaguda Post:Keshavgiri,

Hyderabad-500 005, TELANGANA INDIA  
Tel: 040-64596979,8978380692,Fax: 040-24455003  
E-mail: [ejhod.it@gmail.com](mailto:ejhod.it@gmail.com),  
Website: [www.mist.ac.in](http://www.mist.ac.in),

# MAHAVEER

INSTITUTE OF SCIENCE & TECHNOLOGY

Approved by AICTE, Affiliated to JNTUH,Hyd.



## DEPARTMENT OF INFORMATION TECHNOLOGY

|    |            |                              |
|----|------------|------------------------------|
| 20 | 15E31A1216 | KARKONI NILESH               |
| 21 | 15E31A1217 | KATAM PRIYANKA               |
| 22 | 15E31A1218 | KATHROJU ASHOK               |
| 23 | 15E31A1219 | KOLANU GREESHMA REDDY        |
| 24 | 15E31A1220 | KONIDENA SAI VARSHITHA       |
| 25 | 15E31A1221 | KOTLA VISWASRI               |
| 26 | 15E31A1222 | KURUKUNTLA HARISH SAGAR      |
| 27 | 15E31A1223 | KUSUMA SAI VAMSHI ADITYA     |
| 28 | 15E31A1224 | M BHAGYA LAXMI               |
| 29 | 15E31A1225 | MITTAKANTI ANUSHA            |
| 30 | 15E31A1228 | PINGALI SINDHU               |
| 31 | 15E31A1229 | POSHETTY MANISHA             |
| 32 | 15E31A1231 | SRIPEDEMBUDUR SRINIVAS SWAMY |
| 33 | 15E31A1232 | TUNIKI SHIVAKUMAR            |
| 34 | 15E31A1233 | VILASAGARAM DEVENDAR         |
| 35 | 15E31A1235 | YETHONDA NARAHARIKRISHNA     |
| 36 | 14E31A1213 | K.AKSHAY REDDY               |

*K. Srinivas*  
PRINCIPAL  
MAHAVEER  
INSTITUTE OF SCIENCE & TECHNOLOGY  
Bandlaguda, Hyd-500 005.

*A. K. Srinivas*



Vysapuri, Bandlaguda Post:Keshavgirl,

Hyderabad-500 005, TELANGANA INDIA  
Tel: 040-64506979,8978380692 Fax: 040-24455003  
E-mail: [e3hod.it@gmail.com](mailto:e3hod.it@gmail.com),  
Website: [www.mist.ac.in](http://www.mist.ac.in),

# MAHAVEER

INSTITUTE OF SCIENCE & TECHNOLOGY

Approved by AICTE, Affiliated to JNTUH,Hyd.



## DEPARTMENT OF INFORMATION TECHNOLOGY

### Cloud computing with HADOOP FRAMEWORK QUESTION PAPER

Duration: 120 Minutes

10 X 2 = 20 Marks

Answer the following all questions. Each question carries 2 marks.

1. What is cloud computing?
2. What are the types of cloud?
3. What are the benefits of cloud computing?
4. Is the cloud secure?
5. How do I develop a cloud strategy?
6. What is Hadoop and its components.
7. What are HDFS and YARN?
8. Compare HDFS with Network Attached Storage (NAS).
9. List the difference between Hadoop 1 and Hadoop 2.
10. What happens when two clients try to access the same file in the HDFS?

*Kanthy*

PRINCIPAL  
MAHAVEER  
INSTITUTE OF SCIENCE & TECHNOLOGY  
Bandlaguda, Hyd-500 005.

*Aswathy*  
HOD-IT

Head of Department  
Department of Information Technology  
Institute of Science & Technology  
Bandlaguda, Hyd-500 005.

Vysapuri, Bandlaguda Post; Keshavgirl,

Hyderabad-500 005, TELANGANA INDIA  
Tel: 040-64596979,8978380692,Fax: 040-24455003  
E-mail: [ejhod.it@gmail.com](mailto:ejhod.it@gmail.com),  
Website: [www.mist.ac.in](http://www.mist.ac.in),

# MAHAVEER

INSTITUTE OF SCIENCE & TECHNOLOGY  
Approved by AICTE, Affiliated to JNTUH,Hyd.



## DEPARTMENT OF INFORMATION TECHNOLOGY

### RESULT SHEET FOR Cloud computing with HADOOP FRAMEWORK REGISTERED STUDENTS

| SNO | HALL TICKET NO | NAME OF THE STUDENT        | MARKS (20) | RESULT |
|-----|----------------|----------------------------|------------|--------|
| 1   | 13E31A1201     | AKKINEPALLY SPANDANA       | 20         | PASS   |
| 2   | 13E31A1202     | BADDAM RAI KUMAR           | 19         | PASS   |
| 3   | 13E31A1203     | BURUGU DEEPA               | 20         | PASS   |
| 4   | 13E31A1204     | CHETHI REDDY ARAVIND REDDY | 18         | PASS   |
| 5   | 13E31A1207     | T KAPUNAKAR                | 20         | PASS   |
| 6   | 15E31A1202     | AMAN SINGH BADYAL          | 20         | PASS   |
| 7   | 15E31A1203     | ARUTLA RAJ GOPAL           | 19         | PASS   |
| 8   | 15E31A1204     | BALLA UPENDRA              | 20         | PASS   |
| 9   | 15E31A1205     | BALMOORI SAHITHI           | 18         | PASS   |
| 10  | 15E31A1206     | CHATLA NIKHIL KUMAR        | 20         | PASS   |
| 11  | 15E31A1207     | D KRISHNA SRI              | 20         | PASS   |
| 12  | 15E31A1208     | D LAXMI SAROJA             | 18         | PASS   |
| 13  | 15E31A1209     | DORAGARI NIKHITHA          | 20         | PASS   |
| 14  | 15E31A1210     | DUMALA VENU                | 20         | PASS   |
| 15  | 15E31A1211     | GANDHASIRI BHARATH KUMAR   | 17         | PASS   |
| 16  | 15E31A1212     | GUNNALA SIRISHA            | 20         | PASS   |
| 17  | 15E31A1213     | K RASHMITHA                | 20         | PASS   |
| 18  | 15E31A1214     | KALIGOTA VIGNESH REDDY     | 18         | PASS   |
| 19  | 15E31A1215     | KAPARTHI SRIVARDHAN        | 20         | PASS   |
| 20  | 15E31A1216     | KARKONI NILESH             | 20         | PASS   |
| 21  | 15E31A1217     | KATAM PRIYANKA             | 18         | PASS   |
| 22  | 15E31A1218     | KATHROJU ASHOK             | 20         | PASS   |
| 23  | 15E31A1219     | KOLANU GREESHMA REDDY      | 19         | PASS   |
| 24  | 15E31A1220     | KONIDENA SAI VARSHITHA     | 20         | PASS   |
| 25  | 15E31A1221     | KOTLA VISWASRI             | 18         | PASS   |
| 26  | 15E31A1222     | KURUKUNTLA HARISH SAGAR    | 20         | PASS   |
| 27  | 15E31A1223     | KUSUMA SAI VAMSHI ADITYA   | 20         | PASS   |
| 28  | 15E31A1224     | M BHAGYA LAXMI             | 18         | PASS   |
| 29  | 15E31A1225     | MITTAKANTI ANUSHA          | 20         | PASS   |
| 30  | 15E31A1228     | PINGALI SINDHU             | 20         | PASS   |

*Keshav*  
MAHAVEER  
INSTITUTE OF SCIENCE & TECHNOLOGY  
Bandlaguda, Hyderabad-500

Vysapuri, Bandlaguda Post:Keshavgiri,

Hyderabad-500 005, TELANGANA INDIA  
Tel: 040-64596979,8978380692.Fax: 040-24455003  
E-mail: [g3hod.it@gmail.com](mailto:g3hod.it@gmail.com),  
Website: [www.mist.ac.in](http://www.mist.ac.in),

# MAHAVEER

INSTITUTE OF SCIENCE & TECHNOLOGY

Approved by AICTE, Affiliated to JNTU(Hydr.)



## DEPARTMENT OF INFORMATION TECHNOLOGY

|    |            |                              |    |      |
|----|------------|------------------------------|----|------|
| 31 | 15E31A1229 | POSHETTY MANISHA             | 29 | PASS |
| 32 | 15E31A1231 | SRIPEDAMBUDUR SRINIVAS SWAMY | 18 | PASS |
| 33 | 15E31A1232 | TUNIKI SHIVAKUMAR            | 19 | PASS |
| 34 | 15E31A1233 | VILASAGARAM DEVENDAR         | 18 | PASS |
| 35 | 15E31A1235 | YETHONDA NARAHARIKRISHNA     | 17 | PASS |
| 36 | 14E31A1213 | KAKSHAY REDDY                | 19 | PASS |

No. of students Registered:36

No. of students Passed:36

No. of students failed:NIL

PRINCIPAL  
MAHAVEER  
INSTITUTE OF SCIENCE & TECHNOLOGY  
Bandlaguda, Hyd-500 005.



Vysapuri, Bandlaguda Post: Keshavpuri,

Hyderabad-500 005, TELANGANA INDIA  
Tel: 040-64596979, 8978380692. Fax: 040-24455003  
E-mail: [s3hod.it@gmail.com](mailto:s3hod.it@gmail.com),  
Website: [www.mist.ac.in](http://www.mist.ac.in),

# MAHAVEER

INSTITUTE OF SCIENCE & TECHNOLOGY

Approved by AICTE, Affiliated to JNTUH, Hyd.



## DEPARTMENT OF INFORMATION TECHNOLOGY

### SUMMARY REPORT OF Cloud computing with HADOOP FRAMEWORK

Cloud computing is perhaps the most flamboyant technological innovation of the 21st century. This is because it has seen the fastest adoption into the mainstream than any other technology in the domain.

This adoption has been fueled mainly by the ever-increasing number of smart phones and mobile devices that can access the internet.

Cloud computing is not just for organizations and businesses; it's also useful for the average person as well.

It enables us to run software programs without installing them on our computers; it enables us to store and access our multimedia content via the internet, it enables us to develop and test programs without necessarily having servers and so on.

Hadoop is an open source platform that provides excellent data management provision. It is a framework that supports the processing of large data sets in a distributed computing environment.

It is designed to expand from single servers to thousands of machines, each providing computation and storage.

Its distributed file system facilitates rapid data transfer rates among nodes and allows the system to continue operating uninterrupted in case of a node failure, which minimizes the risk of catastrophic system failure, even if a significant number of nodes become out of action.

COORDINATOR

Copy to:

1. Department Notice Board
2. Principal for Information
3. Committee Members (Academic)

*Keshav*  
PRINCIPAL  
MAHAVEER  
INSTITUTE OF SCIENCE & TECHNOLOGY  
Bandlaguda, Hyd-500 005.

MAHAVEER INSTITUTE OF SCIENCE & TECHNOLOGY  
DEPARTMENT OF INFORMATION TECHNOLOGY

Cloud Computing with HADOOP FRAMEWORK ATTENDANCE SHEET

| SNO | HALL TICKET | NAME OF THE STUDENT        | Date |    |    |    |    |    |    |    |    |    |    |    |    |    |    |    |
|-----|-------------|----------------------------|------|----|----|----|----|----|----|----|----|----|----|----|----|----|----|----|
|     |             |                            | 15   | 16 | 17 | 18 | 19 | 20 | 21 | 22 | 23 | 24 | 25 | 26 | 27 | 28 | 29 | 30 |
| 1   | 15E31A1201  | AKKINEPALLY SPANDANA       | P    | A  | P  | P  | A  | P  | P  | A  | P  | P  | A  | P  | P  | A  | P  | P  |
| 2   | 15E31A1202  | BADDAM RAJ KUMAR           | P    | P  | A  | P  | P  | A  | P  | P  | A  | P  | P  | A  | P  | P  | A  | P  |
| 3   | 15E31A1203  | BURUGU DEEPA               | P    | P  | A  | P  | P  | A  | P  | P  | A  | P  | P  | A  | P  | P  | A  | P  |
| 4   | 15E31A1204  | CHETHI REDDY ARAVIND REDDY | P    | P  | A  | P  | P  | A  | P  | P  | A  | P  | P  | A  | P  | P  | A  | P  |
| 5   | 15E31A1207  | T KARUNAKAR                | P    | P  | A  | P  | P  | A  | P  | P  | A  | P  | P  | A  | P  | P  | A  | P  |
| 6   | 15E31A1202  | AMAN SINGH BADYAI          | P    | P  | A  | P  | P  | A  | P  | P  | A  | P  | P  | A  | P  | P  | A  | P  |
| 7   | 15E31A1203  | ARUTLA RAJ GOPAL           | P    | P  | A  | P  | P  | A  | P  | P  | A  | P  | P  | A  | P  | P  | A  | P  |
| 8   | 15E31A1204  | BALLA UPENDRA              | P    | P  | A  | P  | P  | A  | P  | P  | A  | P  | P  | A  | P  | P  | A  | P  |
| 9   | 15E31A1205  | BALMOORI SAHITHI           | P    | P  | A  | P  | P  | A  | P  | P  | A  | P  | P  | A  | P  | P  | A  | P  |
| 10  | 15E31A1206  | CHATLA NIKHIL KUMAR        | P    | P  | A  | P  | P  | A  | P  | P  | A  | P  | P  | A  | P  | P  | A  | P  |
| 11  | 15E31A1207  | D KRISHNA SRI              | P    | P  | A  | P  | P  | A  | P  | P  | A  | P  | P  | A  | P  | P  | A  | P  |
| 12  | 15E31A1208  | D LAXMI SAROJA             | P    | P  | A  | P  | P  | A  | P  | P  | A  | P  | P  | A  | P  | P  | A  | P  |
| 13  | 15E31A1209  | DORAGARI NIKHITHA          | P    | P  | A  | P  | P  | A  | P  | P  | A  | P  | P  | A  | P  | P  | A  | P  |
| 14  | 15E31A1210  | DUMALA VENU                | P    | P  | A  | P  | P  | A  | P  | P  | A  | P  | P  | A  | P  | P  | A  | P  |
| 15  | 15E31A1211  | GANDHASIRI BHARATHI KUMAR  | P    | P  | A  | P  | P  | A  | P  | P  | A  | P  | P  | A  | P  | P  | A  | P  |
| 16  | 15E31A1212  | GUNNALA SIRISHA            | P    | P  | A  | P  | P  | A  | P  | P  | A  | P  | P  | A  | P  | P  | A  | P  |
| 17  | 15E31A1213  | K RASHMITHA                | P    | P  | A  | P  | P  | A  | P  | P  | A  | P  | P  | A  | P  | P  | A  | P  |
| 18  | 15E31A1214  | KALIGOTA VIGNESH REDDY     | P    | P  | A  | P  | P  | A  | P  | P  | A  | P  | P  | A  | P  | P  | A  | P  |
| 19  | 15E31A1215  | KAPARTHI SRIVARDHAN        | P    | P  | A  | P  | P  | A  | P  | P  | A  | P  | P  | A  | P  | P  | A  | P  |
| 20  | 15E31A1216  | KARKONI NILESH             | P    | P  | A  | P  | P  | A  | P  | P  | A  | P  | P  | A  | P  | P  | A  | P  |
| 21  | 15E31A1217  | KATAM PRIYANKA             | P    | P  | A  | P  | P  | A  | P  | P  | A  | P  | P  | A  | P  | P  | A  | P  |
| 22  | 15E31A1218  | KATHROJU ASHOK             | P    | P  | A  | P  | P  | A  | P  | P  | A  | P  | P  | A  | P  | P  | A  | P  |
| 23  | 15E31A1219  | KOLANU GREEESHMA REDDY     | P    | P  | A  | P  | P  | A  | P  | P  | A  | P  | P  | A  | P  | P  | A  | P  |
| 24  | 15E31A1220  | KONIDENA SAI VARSHITHA     | P    | P  | A  | P  | P  | A  | P  | P  | A  | P  | P  | A  | P  | P  | A  | P  |
| 25  | 15E31A1221  | KOTLA VISWASRI             | P    | P  | A  | P  | P  | A  | P  | P  | A  | P  | P  | A  | P  | P  | A  | P  |
| 26  | 15E31A1222  | KURUKUNTLA HARISH SAGAR    | P    | P  | A  | P  | P  | A  | P  | P  | A  | P  | P  | A  | P  | P  | A  | P  |
| 27  | 15E31A1223  | KUSUMA SAI VAMSHI ADITYA   | P    | P  | A  | P  | P  | A  | P  | P  | A  | P  | P  | A  | P  | P  | A  | P  |
| 28  | 15E31A1224  | M BHAGYA LAXMI             | P    | P  | A  | P  | P  | A  | P  | P  | A  | P  | P  | A  | P  | P  | A  | P  |

W. PRINCIPAL  
MAHAVEER  
INSTITUTE OF SCIENCE & TECHNOLOGY  
CLOUD-500 005







Vysapuri, Bandlaguda Post:Keshavgiri,  
Hyderabad-500 005, Telangana INDIA  
Tel: 040-64596979,20020773, Fax: 040-24455003  
E-mail: [principal.mahaveer@gmail.com](mailto:principal.mahaveer@gmail.com),  
Website: [www.mist.ac.in](http://www.mist.ac.in),

**MAHAVEER**  
INSTITUTE OF SCIENCE & TECHNOLOGY  
Approved by AICTE, Affiliated to JNTUH,Hyd.



---

**DEPARTMENT OF AERONAUTICAL ENGINEERING**

**PROPOSAL LETTER**

Hyderabad,  
10/08/2016.

To,  
The principal,  
MIST,  
Hyderabad.

Sub: Proposal for two weeks workshop on Micro Category Multi rotor Drone Pilot Course-Reg,

Dear Sir,

We are working as asst professor in the department of AERONAUTICAL ENGINEERING. Sir, we are going to conduct three weeks workshop on Micro Category Multi rotor Drone Pilot Course. We require your approval to go head for further proceeding and hope to get an opportunity to serve you the best .

With thanks and Regards

From,  
AERO Department  
Mist,  
Bandlaguda,

*Handwritten signature*  
PRINCIPAL  
MAHAVEER  
INSTITUTE OF SCIENCE & TECHNOLOGY  
Bandlaguda, Hyd-500 005.

*Handwritten signature*

Vysapuri, Bandlaguda Post:Keshavgiri,  
Hyderabad-500 005, Telangana INDIA  
Tel: 040-84596979,20020773, Fax: 040-24455003  
E-mail: [principal.mahaveer@gmail.com](mailto:principal.mahaveer@gmail.com),  
Website: [www.mist.ac.in](http://www.mist.ac.in),

**MAHAVEER**  
INSTITUTE OF SCIENCE & TECHNOLOGY  
Approved by AICTE, Affiliated to JNTUH,Hyd.



---

## DEPARTMENT OF AERONAUTICAL ENGINEERING

Date: 12.08.2016

### CIRCULAR

Technical Training for II B. Tech students are starting from 12-08-2016 onwards. All HODs and Placements coordinators have to manage the trainings and ensure 95% attendance all through the sessions.

All Mentors need to send the compiled feedback report to A RangaReddy, HOD at [e3hod.aero@gmail.com](mailto:e3hod.aero@gmail.com) daily.

Agenda: 1. **Micro Category Multirotor Drone Pilot Course**

Prof RANGA REDDY  
HOD

Course Designed By

Y RAGHUVeer

G RAJESH KUMAR

*Keshavgiri*  
PRINCIPAL  
MAHAVEER  
INSTITUTE OF SCIENCE & TECHNOLOGY  
Bandlaguda, Hyd-500 005.



## Multi rotor Drone Pilot Course

### SYLLABUS

#### 1: Introduction to Multirotor Drones, DGCA Regulations

- Regulations of DGCA
- Basic Principles of Flight
- Multirotor Introduction
- Drone Equipment Maintenance

#### 2: Introduction to Flight Simulator Training

- Introduction to Flight Simulator
- Flight Simulator Training

#### 3: Important Parts and Components in a Multirotor

- Drone Assembling
- Identification of each component in a Multirotor Assembling and calibrating
- Practical flying with instructor

*Keshav*  
PRINCIPAL  
MAHAVEER  
INSTITUTE OF SCIENCE & TECHNOLOGY  
Bandlaguda, Hyd-500 005.





**Multi rotor Drone Pilot Course**

**STUDENT LIST 2016-17**

|    | Hall Ticket No | Name of the Candidate       | year |
|----|----------------|-----------------------------|------|
| 1  | 14E31A2101     | ABDUL AZIZ                  | II   |
| 2  | 14E31A2102     | BHUKYA VENKATESH            | II   |
| 3  | 14E31A2103     | BRAHMANLAPALLY SAI KIRAN    | II   |
| 4  | 14E31A2104     | CH PHANEENDRA               | II   |
| 5  | 14E31A2105     | CHEEKATI PREETHI RACHEL     | II   |
| 6  | 14E31A2106     | CHOPPALA VISHAL             | II   |
| 7  | 14E31A2108     | GUMMADI ANIRUDH             | II   |
| 8  | 14E31A2109     | GUVVALA RAKESH              | II   |
| 9  | 14E31A2110     | INDROJU ARCHITHA            | II   |
| 10 | 14E31A2111     | KESHABOINA RAHUL            | II   |
| 11 | 14E31A2112     | KISARI NITHIN KUMAR         | II   |
| 12 | 14E31A2113     | MALIK NOUMAN BADR           | II   |
| 13 | 14E31A2114     | MARKANTI ANJANEYULU         | II   |
| 14 | 14E31A2116     | MD ALTAMASH NIZAMI AL SABHA | II   |
| 15 | 14E31A2117     | MOHAMMAD ADNAN              | II   |
| 16 | 14E31A2118     | MOHAMMAD FAIYAZ             | II   |
| 17 | 14E31A2119     | MOHAMMED ABDUL QADEER       | II   |
| 18 | 14E31A2120     | MOHD ABDUL MALIK YASER      | II   |
| 19 | 14E31A2121     | MOHD MAJID ALI INSHAAL      | II   |
| 20 | 14E31A2122     | MOTHA SAIKIRAN              | II   |
| 21 | 14E31A2123     | MOTHUKURI SAI KRISHNA       | II   |
| 22 | 14E31A2124     | MUDA VATH ANIL              | II   |
| 23 | 14E31A2125     | MURAHARI KISHORE            | II   |
| 24 | 14E31A2126     | MYATHARI SALOMON            | II   |
| 25 | 14E31A2127     | PEDHAGOVINDU SURYANSH SAGAR | II   |
| 26 | 14E31A2128     | PERAM AMULYA                | II   |
| 27 | 14E31A2129     | POTLURU JAGADEESH           | II   |

*Kishu*  
PRINCIPAL  
MAHAVEER  
INSTITUTE OF SCIENCE & TECHNOLOGY  
Bandlaguda, Hyd-500 005.

*[Signature]*  
HOD



Technical Training Exam on  
(A.Y-2016-17)

4x5=20 Marks

Answer All the QuestionsMultirotor Drone Pilot Course

1. Basic Principles of Flight?
2. Multi rotor Introduction?
3. Drone Equipment Maintenance?
4. Drone Assembling?

*Kanhy*

PRINCIPAL  
MAHAVEER  
INSTITUTE OF SCIENCE & TECHNOLOGY  
Bandlaguda, Hydr-500 005.



## Micro Category Multi rotor Drone Pilot Course

### Training student marks list 2016-17

| S NO | Hall Ticket No | Name of the Candidate       | year | marks | pass/fail |
|------|----------------|-----------------------------|------|-------|-----------|
| 1    | 14E31A2101     | ABDUL AZIZ                  | II   | 18    | pass      |
| 2    | 14E31A2102     | BHUKYA VENKATESH            | II   | 17    | pass      |
| 3    | 14E31A2103     | BRAHMANLAPALLY SAI KIRAN    | II   | 15    | pass      |
| 4    | 14E31A2104     | CH PHANEENDRA               | II   | 17    | pass      |
| 5    | 14E31A2105     | CHEEKATI PREETHI RACHEL     | II   | 16    | pass      |
| 6    | 14E31A2106     | CHOPPALA VISHAL             | II   | 12    | pass      |
| 7    | 14E31A2108     | GUMMADI ANIRUDH             | II   | 17    | pass      |
| 8    | 14E31A2109     | GUVALA RAKESH               | II   | 13    | pass      |
| 9    | 14E31A2110     | INDROJU ARCHITHA            | II   | 17    | pass      |
| 10   | 14E31A2111     | KESHABOINA RAHUL            | II   | 17    | pass      |
| 11   | 14E31A2112     | KISARI NITHIN KUMAR         | II   | 15    | pass      |
| 12   | 14E31A2113     | MALIK NOUMAN BADR           | II   | 17    | pass      |
| 13   | 14E31A2114     | MARKANTI ANJANEYULU         | II   | 12    | pass      |
| 14   | 14E31A2116     | MD ALTAMASH NIZAMI AL SABHA | II   | 17    | pass      |
| 15   | 14E31A2117     | MOHAMMAD ADNAN              | II   | 16    | pass      |
| 16   | 14E31A2118     | MOHAMMAD FAIYAZ             | II   | 17    | pass      |
| 17   | 14E31A2119     | MOHAMMED ABDUL QADEER       | II   | 19    | pass      |
| 18   | 14E31A2120     | MOHD ABDUL MALIK YASER      | II   | 17    | pass      |
| 19   | 14E31A2121     | MOHD MAJID ALI INSHAAL      | II   | 16    | pass      |
| 20   | 14E31A2122     | MOTHA SAIKIRAN              | II   | 17    | pass      |
| 21   | 14E31A2123     | MOTHUKURI SAI KRISHNA       | II   | 18    | pass      |
| 22   | 14E31A2124     | MUDAVATH ANIL               | II   | 17    | pass      |
| 23   | 14E31A2125     | MURAHARI KISHORE            | II   | 15    | pass      |
| 24   | 14E31A2126     | MYATHARI SALOMON            | II   | 17    | pass      |
| 25   | 14E31A2127     | PEDHAGOVINDU SURYANSH SAGAR | II   | 17    | pass      |
| 26   | 14E31A2128     | PERAM AMULYA                | II   | 15    | pass      |
| 27   | 14E31A2129     | POTLURU JAGADEESH           | II   | 17    | pass      |

*Kanishk*  
MAHAVEER  
INSTITUTE OF SCIENCE & TECHNOLOGY  
Bandlaguda, Hydr-500 005.

*A. Annureddy*  
HOD



**MAHAVEER INSTITUTE OF SCIENCE AND TECHNOLOGY**  
**AERONAUTICAL ENGINEERING**  
**COURSE ATTENDANCE LIST**

| S NO | HT NO      | NAME                        | DATE | 12 | 13 | 14 | 15 | 16 | 17 | 18 | 19 | 20 | 21 | 22 | 23 | 24 | 25 | 26 |
|------|------------|-----------------------------|------|----|----|----|----|----|----|----|----|----|----|----|----|----|----|----|
| 1    | 14E31A2101 | ABDUL AZIZ                  |      | P  | P  | P  | P  | P  | P  | P  | P  | P  | P  | P  | P  | P  | P  | P  |
| 2    | 14E31A2102 | BHUKYA VENKATESH            |      | P  | P  | P  | P  | P  | P  | P  | P  | P  | P  | P  | P  | P  | P  | P  |
| 3    | 14E31A2103 | BRAHMANLAPALLY SAI KIRAN    |      | P  | P  | P  | P  | P  | P  | P  | P  | P  | P  | P  | P  | P  | P  | P  |
| 4    | 14E31A2104 | CH PHANEENDRA               |      | P  | P  | P  | P  | P  | P  | P  | P  | P  | P  | P  | P  | P  | P  | P  |
| 5    | 14E31A2105 | CHEEKATI PREETHI RACHEL     |      | P  | P  | P  | P  | P  | P  | P  | P  | P  | P  | P  | P  | P  | P  | P  |
| 6    | 14E31A2106 | CHOPPALA VISHAL             |      | P  | P  | P  | P  | P  | P  | P  | P  | P  | P  | P  | P  | P  | P  | P  |
| 7    | 14E31A2108 | GUMMADI ANIRUDH             |      | P  | P  | P  | P  | P  | P  | P  | P  | P  | P  | P  | P  | P  | P  | P  |
| 8    | 14E31A2109 | GUVVALA RAKESH              |      | P  | P  | P  | P  | P  | P  | P  | P  | P  | P  | P  | P  | P  | P  | P  |
| 9    | 14E31A2110 | INDROJU ARCHITHA            |      | P  | P  | P  | P  | P  | P  | P  | P  | P  | P  | P  | P  | P  | P  | P  |
| 10   | 14E31A2111 | KESHABOINA RAHUL            |      | P  | P  | P  | P  | P  | P  | P  | P  | P  | P  | P  | P  | P  | P  | P  |
| 11   | 14E31A2112 | KISARI NITHIN KUMAR         |      | P  | P  | P  | P  | P  | P  | P  | P  | P  | P  | P  | P  | P  | P  | P  |
| 12   | 14E31A2113 | MALIK NOUMAN BADR           |      | P  | P  | P  | P  | P  | P  | P  | P  | P  | P  | P  | P  | P  | P  | P  |
| 13   | 14E31A2114 | MARKANTI ANJANEYULU         |      | P  | P  | P  | P  | P  | P  | P  | P  | P  | P  | P  | P  | P  | P  | P  |
| 14   | 14E31A2116 | MD ALTAMASH NIZAMI AL SABHA |      | P  | P  | P  | P  | P  | P  | P  | P  | P  | P  | P  | P  | P  | P  | P  |
| 15   | 14E31A2117 | MOHAMMAD ADNAN              |      | P  | P  | P  | P  | P  | P  | P  | P  | P  | P  | P  | P  | P  | P  | P  |
| 16   | 14E31A2118 | MOHAMMAD FAIYAZ             |      | P  | P  | P  | P  | P  | P  | P  | P  | P  | P  | P  | P  | P  | P  | P  |
| 17   | 14E31A2119 | MOHAMMED ABDUL QADEER       |      | P  | P  | P  | P  | P  | P  | P  | P  | P  | P  | P  | P  | P  | P  | P  |
| 18   | 14E31A2120 | MOHD ABDUL MALIK YASER      |      | P  | P  | P  | P  | P  | P  | P  | P  | P  | P  | P  | P  | P  | P  | P  |
| 19   | 14E31A2121 | MOHD MAJID ALI INSHAAL      |      | P  | P  | P  | P  | P  | P  | P  | P  | P  | P  | P  | P  | P  | P  | P  |
| 20   | 14E31A2122 | MOTHA SAIKIRAN              |      | P  | P  | P  | P  | P  | P  | P  | P  | P  | P  | P  | P  | P  | P  | P  |
| 21   | 14E31A2123 | MOTHUKURI SAI KRISHNA       |      | P  | P  | P  | P  | P  | P  | P  | P  | P  | P  | P  | P  | P  | P  | P  |
| 22   | 14E31A2124 | MUDAVATH ANIL               |      | P  | P  | P  | P  | P  | P  | P  | P  | P  | P  | P  | P  | P  | P  | P  |
| 23   | 14E31A2125 | MURAHARI KISHORE            |      | P  | P  | P  | P  | P  | P  | P  | P  | P  | P  | P  | P  | P  | P  | P  |
| 24   | 14E31A2126 | MYATHARI SALOMON            |      | P  | P  | P  | P  | P  | P  | P  | P  | P  | P  | P  | P  | P  | P  | P  |
| 25   | 14E31A2127 | PEDHAGOVINDU SURYANSH SAGAR |      | P  | P  | P  | P  | P  | P  | P  | P  | P  | P  | P  | P  | P  | P  | P  |
| 26   | 14E31A2128 | PERAM AMULYA                |      | P  | P  | P  | P  | P  | P  | P  | P  | P  | P  | P  | P  | P  | P  | P  |
| 27   | 14E31A2129 | POTLURU JAGADEESH           |      | P  | P  | P  | P  | P  | P  | P  | P  | P  | P  | P  | P  | P  | P  | P  |

*K. Hanthi*  
**PRINCIPAL**  
**MAHAVEER**  
**INSTITUTE OF SCIENCE & TECHNOLOGY**  
 Landmark: HYD-103 016

*W. Anand*  
**HOD**



## Course :Multi rotor Drone Pilot Course

### Report summary

A multirotor or multicopter is a rotorcraft with more than two lift-generating rotors. An advantage of multirotor aircraft is the simpler rotor mechanics required for flight control. Unlike single- and double-rotor helicopters which use complex variable pitch rotors whose pitch varies as the blade rotates for flight stability and control, multirotors often use fixed-pitch blades; control of vehicle motion is achieved by varying the relative speed of each rotor to change the thrust and torque produced by each.

There are four main physical types of professional drones: multi-rotor, fixed-wing, single-rotor helicopter, and fixed-wing hybrid VTOL. The different body styles of each type of drone contribute to the amount of weight they can carry (payload), efficiency and duration of the flight.

*N. Dammakany*

HOD

*K. Sankar*  
MAHAVEER  
INSTITUTE OF SCIENCE & TECHNOLOGY  
Bandlaguda, Hydr-500 005

Vysapuri, Bandlaguda Post:Keshavgiri,  
Hyderabad-500 905, Telangana INDIA  
Tel: 040-64596979,20020773, Fax: 040-24455003  
E-mail: [principal.mahaveer@gmail.com](mailto:principal.mahaveer@gmail.com),  
Website: [www.mist.ac.in](http://www.mist.ac.in),

# MAHAVEER

INSTITUTE OF SCIENCE & TECHNOLOGY

Approved by AICTE, Affiliated to JNTUH,Hyd.



## CERTIFICATE OF COURSE COMPLETION

This certificate is presented to BHUKYA VENKATESH of MIST, who has successfully completed technical training course on “Micro Category Multirotor Drone Pilot Course” held from 12-08-2016 to 26-08-2016 and found the student performance to be excellent.



ESTD : 2001

A RANGA REDDY

HOD (AERO)

*Kanika*  
MAHAVEER  
INSTITUTE OF SCIENCE & TECHNOLOGY  
Bandlaguda, Hyd-500 905



Vysapuri, Bandlaguda Post:Keshavgiri,

Hyderabad-500 005, TELANGANA INDIA  
Tel: 040-64596979,8978380692,Fax: 040-24455003  
E-mail: [e3hod.it@gmail.com](mailto:e3hod.it@gmail.com),  
Website: [www.mist.ac.in](http://www.mist.ac.in),

**MAHAVEER**  
**INSTITUTE OF SCIENCE & TECHNOLOGY**  
Approved by AICTE, Affiliated to JNTUH,Hyd.



## DEPARTMENT OF HUMANITIES AND SCIENCES

Date: 25-08-16

To,  
The principal,  
MIST ,  
Hyderabad.

Sub: Proposal for Add-on-course-Reg  
Dear sir,

We are going to conduct Add-On course on Atomic structure. we require your approval to go head for further proceeding and hope to get an opportunity to serve you the best.

With thanks and Regards

  
PRINCIPAL  
MAHAVEER  
INSTITUTE OF SCIENCE & TECHNOLOGY  
Bandlaguda, Hyd-500 005.

  
HOD  
Department of Humanities & Sciences  
Mahaveer Institute of Science & Technology,  
HYDERABAD

Vysapuri, Bandlaguda Post:Keshavgiri,

Hyderabad-500 005, TELANGANA INDIA

Tel: 040-64596979,8978380692,Fax: 040-24455003

E-mail: [e3hod.it@gmail.com](mailto:e3hod.it@gmail.com),

Website: [www.mist.ac.in](http://www.mist.ac.in),

**MAHAVEER**  
**INSTITUTE OF SCIENCE & TECHNOLOGY**  
Approved by AICTE, Affiliated to JNTUH,Hyd.



## DEPARTMENT OF HUMANITIES AND SCIENCES

Date: 25-08-16

### CIRCULAR

CRASH COURSE FOR I B.Tech students are starting from 25-08-16 onwards. All HODs and placements coordinators have to manage the trainings and ensure 95% attendance all through the sessions.

All mentors need to send the compiled feedback report to HOD at [e3hod@gmail.com](mailto:e3hod@gmail.com) daily. Mentors are advised to take care of PNR (Students not participating in training).

Agenda: **ATOMIC STRUCTURE**

**Design and Development of Curriculum for Add on Course**

Name of Faculty: 1.Dr.Deetphi  
2.Ayya swamy

  
PRINCIPAL  
MAHAVEER  
INSTITUTE OF SCIENCE & TECHNOLOGY  
Bandlaguda, Hyd-500 005.

  
HOD  
Department of Humanities & Sciences  
Mahaveer Institute of Science & Technology  
HYDERABAD

**HOD**

Vysapuri, Bandlaguda Post:Keshavgiri,

Hyderabad-500 005, TELANGANA INDIA

Tel: 040-64596979,8978380692,Fax: 040-24455003

E-mail: [e3hod.it@gmail.com](mailto:e3hod.it@gmail.com),

Website: [www.mist.ac.in](http://www.mist.ac.in),

**MAHAVEER**  
INSTITUTE OF SCIENCE & TECHNOLOGY

Approved by AICTE, Affiliated to JNTUH,Hyd.

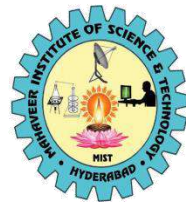

## DEPARTMENT OF HUMANITIES AND SCIENCES

### SYLLABUS FOR ATOMIC STRUCTURE

| SNO | TOPIC COVERED                             | DURATION |
|-----|---|----------|
| 1   | Sub-atomic Particles.                     | 3        |
| 2   | Atomic models.                            | 3        |
| 3   | Dual nature of Matter.                    | 3        |
| 4   | Photoelectric Effect.                     | 3        |
| 5   | Electromagnetic Radiations.               | 3        |
| 6   | Quantum Mechanical Model of Atoms.        | 3        |
| 7   | Electronic Configuration.                 | 3        |
| 8   | Discovery of Electron Proton and Neutron. | 3        |

PRINCIPAL  
MAHAVEER  
INSTITUTE OF SCIENCE & TECHNOLOGY  
Bandlaguda, Hyd-500 005.

HOD  
Department of Humanities & Sciences  
Mahaveer Institute of Science & Technology,  
HYDERABAD

HOD



Vysapuri, Bandlaguda Post:Keshavgi,

Hyderabad-500 005, TELANGANA INDIA

Tel: 040-64596979,8978380692,Fax: 040-24455003

E-mail: [e3hod.it@gmail.com](mailto:e3hod.it@gmail.com),

Website: [www.mist.ac.in](http://www.mist.ac.in),

**MAHAVEER**  
INSTITUTE OF SCIENCE & TECHNOLOGY

Approved by AICTE, Affiliated to JNTUH,Hyd.

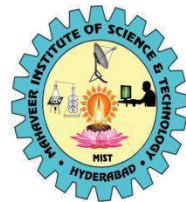

## DEPARTMENT OF HUMANITIES AND SCIENCES

### LIST OF REGISTERED STUDENTENS FOR ATOMIC STRUCTURE

| SNO | HOLL TICKET NO | NAME OF THE STUDENT  |
|-----|----------------|----------------------|
| 1   | 16E31A0407     | B NAVYA SRI          |
| 2   | 16E31A0413     | DESHAM PREETHIKA     |
| 3   | 16E31A0435     | PAKEER GANESH        |
| 4   | 16E31A0465     | B PRADEEP            |
| 5   | 16E31A04A0     | THOTA NARESH         |
| 6   | 16E31A0212     | K VEERESH            |
| 7   | 16E31A0222     | MUTHINENI VAMSHI     |
| 8   | 16E31A0225     | PUNNA VAISHNAVI      |
| 9   | 16E31A0228     | ROSHAN PATNAIK       |
| 10  | 16E31A1202     | ADURLA PAVAN         |
| 11  | 16E31A1219     | PAIPATI SHILPA REDDY |
| 12  | 16E31A1228     | VADHADIYA SRINA      |
| 13  | 16E31A1231     | YASA ABHINAYA        |
| 14  | 16E31A0505     | AVULA VAISHNAVI      |
| 15  | 16E31A0518     | KONDA SOWMYA         |
| 16  | 16E31A0564     | BOMMA NITIN          |
| 17  | 16E31A0578     | JAKKULA NARESH       |
| 18  | 16E31A0585     | MAROJU SHIVANI       |
| 19  | 16E31A0593     | NATTI SRILEKHA       |
| 20  | 16E31A05B3     | AKULA VARSHINI       |
| 21  | 16E31A05C7     | KODALI SAI KRISHNA   |
| 22  | 16E31A05F0     | VOJJALA MANASA       |
| 23  | 16E31A0306     | G VENU GOPAL         |
| 24  | 16E31A0313     | KOVA SAIKUMAR        |
| 25  | 16E31A0324     | NALLA TEJASWI        |

*Keshavgi*

PRINCIPAL  
MAHAVEER  
INSTITUTE OF SCIENCE & TECHNOLOGY  
Bandlaguda, Hyd-500 005.

Vysapuri, Bandlaguda Post:Keshavgi,

Hyderabad-500 005, TELANGANA INDIA

Tel: 040-64596979,8978380692,Fax: 040-24455003

E-mail: [e3hod.it@gmail.com](mailto:e3hod.it@gmail.com),

Website: [www.mist.ac.in](http://www.mist.ac.in),

# MAHAVEER

INSTITUTE OF SCIENCE & TECHNOLOGY

Approved by AICTE, Affiliated to JNTUH,Hyd.

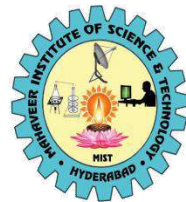

## DEPARTMENT OF HUMANITIES AND SCIENCES

### ATOMIC STRUCTURE QUESTION PAPER

DURATION:120 MINUTES

MAX.MARKS 50

ANSWER ANY FIVE QUESTION.

5\*10=50

1. what are Atomic models.
2. Discribe Dual nature of Matter
3. Explain the concept of Photoelectric Effect
4. Explain Quantum Mechanical Model of Atoms
5. What is Electronic Configuration
6. Explain the process of Discovery of Electron Proton and Neutron

PRINCIPAL  
MAHAVEER  
INSTITUTE OF SCIENCE & TECHNOLOGY  
Bandlaguda, Hyd-500 005.

Vysapuri, Bandlaguda Post:Keshavgi,

Hyderabad-500 005, TELANGANA INDIA

Tel: 040-64596979,8978380692,Fax: 040-24455003

E-mail: [e3hod.it@gmail.com](mailto:e3hod.it@gmail.com),

Website: [www.mist.ac.in](http://www.mist.ac.in),

# MAHAVEER

## INSTITUTE OF SCIENCE & TECHNOLOGY

Approved by AICTE, Affiliated to JNTUH,Hyd.

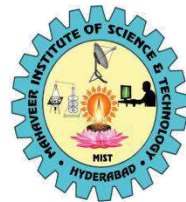

### DEPARTMENT OF HUMANITIES AND SCIENCES

#### RESULT SHEET FOR ATOMIC STRUCTURE REGISTERED STUDENTS

| SNO | HOLL TICKET NO | NAME OF THE STUDENT  | MARKS(20) | RESULT |
|-----|----------------|----------------------|-----------|--------|
| 1   | 16E31A0407     | B NAVYA SRI          | 20        | PASS   |
| 2   | 16E31A0413     | DESHAM PREETHIKA     | 19        | PASS   |
| 3   | 16E31A0435     | PAKEER GANESH        | 20        | PASS   |
| 4   | 16E31A0465     | B PRADEEP            | 18        | PASS   |
| 5   | 16E31A04A0     | THOTA NARESH         | 20        | PASS   |
| 6   | 16E31A0212     | K VEERESH            | 19        | PASS   |
| 7   | 16E31A0222     | MUTHINENI VAMSHI     | 18        | PASS   |
| 8   | 16E31A0225     | PUNNA VAISHNAVI      | 20        | PASS   |
| 9   | 16E31A0228     | ROSHAN PATNAIK       | 18        | PASS   |
| 10  | 16E31A1202     | ADURLA PAVAN         | 18        | PASS   |
| 11  | 16E31A1219     | PAIPATI SHILPA REDDY | 19        | PASS   |
| 12  | 16E31A1228     | VADHADIYA SRINA      | 19        | PASS   |
| 13  | 16E31A1231     | YASA ABHINAYA        | 20        | PASS   |
| 14  | 16E31A0505     | AVULA VAISHNAVI      | 20        | PASS   |
| 15  | 16E31A0518     | KONDA SOWMYA         | 20        | PASS   |
| 16  | 16E31A0564     | BOMMA NITIN          | 19        | PASS   |
| 17  | 16E31A0578     | JAKKULA NARESH       | 19        | PASS   |
| 18  | 16E31A0585     | MAROJU SHIVANI       | 18        | PASS   |
| 19  | 16E31A0593     | NATTI SRILEKHA       | 18        | PASS   |
| 20  | 16E31A05B3     | AKULA VARSHINI       | 20        | PASS   |
| 21  | 16E31A05C7     | KODALI SAI KRISHNA   | 18        | PASS   |
| 22  | 16E31A05F0     | VOJJALA MANASA       | 17        | PASS   |
| 23  | 16E31A0306     | G VENU GOPAL         | 16        | PASS   |
| 24  | 16E31A0313     | KOVA SAIKUMAR        | 20        | PASS   |
| 25  | 16E31A0324     | NALLA TEJASWI        | 19        | PASS   |

No.of students registred:20

No.of students passed :20

No.of students failed :Nil

PRINCIPAL  
**MAHAVEER**  
INSTITUTE OF SCIENCE & TECHNOLOGY  
Bandlaguda, Hyd-500 005.

HOD  
Department of Humanities & Sciences  
Mahaveer Institute of Science & Technology,  
HYDERABAD



Vysapuri, Bandlaguda Post:Keshavgiri,

Hyderabad-500 005, TELANGANA INDIA

Tel: 040-64596979,8978380692,Fax: 040-24455003

E-mail: [e3hod.it@gmail.com](mailto:e3hod.it@gmail.com),

Website: [www.mist.ac.in](http://www.mist.ac.in),

**MAHAVEER**  
INSTITUTE OF SCIENCE & TECHNOLOGY

Approved by AICTE, Affiliated to JNTUH,Hyd.

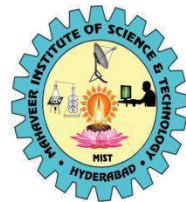

## DEPARTMENT OF HUMANITIES AND SCIENCES

### SUMMARY REPORT OF CERTIFICATE COURSE ON ATOMIC STRUCTURE

Atoms consist of protons and neutrons in the nucleus, surrounded by electrons that reside in orbitals. Orbitals are classified according to the four quantum numbers that represent any one particular orbital's energy, shape, orientation, and the spin of the occupying electron. The first section of this SparkNote on Atomic Structure will focus on the electron and the mechanism of describing electrons and their orbitals. As we shall see in the second section, electrons fill up orbitals in a systematic fashion, following the rules of the Aufbau principle. The configuration of electrons in an atom play a vital role in chemistry. Virtually every chemical process relies on the interactions of electrons between atoms, most particularly on the tendency of atoms to follow the octet rule, the tendency to gain a full valence shell electrons. In the second section of this SparkNote, we will discuss the properties of electrons, distinguishing between valence electrons and inner electrons, then broadening the discussion into an examination of the properties of electron configurations.

#### COPY TO:

1. Department notice board.
2. Principal for information
3. committee members (academic)

  
PRINCIPAL  
MAHAVEER  
INSTITUTE OF SCIENCE & TECHNOLOGY  
Bandlaguda, Hyd-500 005.

**MAHAVEER INSTITUTE OF SCIENCE & TECHNOLOGY**  
**DEPARTMENT OF HUMANITIES AND SCIENCE**  
**ATOMIC STRUCTURE ATTENDANCE SHEET**

| S.NO | H.T NO     | NAME OF THE STUDENT  | Date |   |   |   |   |   |   |   |   |    |    |    |    |    |    |    |    |    |    |    |
|------|------------|----------------------|------|---|---|---|---|---|---|---|---|----|----|----|----|----|----|----|----|----|----|----|
|      |            |                      | 1    | 2 | 3 | 4 | 5 | 6 | 7 | 8 | 9 | 10 | 11 | 12 | 13 | 14 | 15 | 16 | 17 | 18 | 19 | 20 |
| 1    | 16E31A0407 | B NAVYA SRI          | P    | P | P | P | P | P | P | P | P | P  | P  | P  | P  | P  | P  | P  | P  | P  | P  | P  |
| 2    | 16E31A0413 | DESHAM PREETHIKA     | P    | P | P | P | P | P | P | P | P | P  | P  | P  | P  | P  | P  | P  | P  | P  | P  | P  |
| 3    | 16E31A0435 | PAKEER GANESH        | P    | P | P | P | P | P | P | P | P | P  | P  | P  | P  | P  | P  | P  | P  | P  | P  | P  |
| 4    | 16E31A0465 | B PRADEEP            | P    | P | P | P | P | P | P | P | P | P  | P  | P  | P  | P  | P  | P  | P  | P  | P  | P  |
| 5    | 16E31A04A0 | THOTA NARESH         | P    | P | P | P | P | P | P | P | P | P  | P  | P  | P  | P  | P  | P  | P  | P  | P  | P  |
| 6    | 16E31A0212 | K VEERESH            | P    | P | P | P | P | P | P | P | P | P  | P  | P  | P  | P  | P  | P  | P  | P  | P  | P  |
| 7    | 16E31A0222 | MUTHINENI VAMSHI     | P    | P | P | P | P | P | P | P | P | P  | P  | P  | P  | P  | P  | P  | P  | P  | P  | P  |
| 8    | 16E31A0225 | PUNNA VAISHNAVI      | P    | P | P | P | P | P | P | P | P | P  | P  | P  | P  | P  | P  | P  | P  | P  | P  | P  |
| 9    | 16E31A0228 | ROSHAN PATNAIK       | P    | P | P | P | P | P | P | P | P | P  | P  | P  | P  | P  | P  | P  | P  | P  | P  | P  |
| 10   | 16E31A1202 | ADURLA PAVAN         | P    | P | P | P | P | P | P | P | P | P  | P  | P  | P  | P  | P  | P  | P  | P  | P  | P  |
| 11   | 16E31A1219 | PAIPATI SHILPA REDDY | P    | P | P | P | P | P | P | P | P | P  | P  | P  | P  | P  | P  | P  | P  | P  | P  | P  |
| 12   | 16E31A1228 | VADHADIYA SRINA      | P    | P | P | P | P | P | P | P | P | P  | P  | P  | P  | P  | P  | P  | P  | P  | P  | P  |
| 13   | 16E31A1231 | YASA ABHINAYA        | P    | P | P | P | P | P | P | P | P | P  | P  | P  | P  | P  | P  | P  | P  | P  | P  | P  |
| 14   | 16E31A0505 | AVULA VAISHNAVI      | P    | P | P | P | P | P | P | P | P | P  | P  | P  | P  | P  | P  | P  | P  | P  | P  | P  |
| 15   | 16E31A0518 | KONDA SOWMYA         | P    | P | P | P | P | P | P | P | P | P  | P  | P  | P  | P  | P  | P  | P  | P  | P  | P  |
| 16   | 16E31A0564 | BOMMA NITIN          | P    | P | P | P | P | P | P | P | P | P  | P  | P  | P  | P  | P  | P  | P  | P  | P  | P  |
| 17   | 16E31A0578 | JAKKULA NARESH       | P    | P | P | P | P | P | P | P | P | P  | P  | P  | P  | P  | P  | P  | P  | P  | P  | P  |
| 18   | 16E31A0585 | MAROJU SHIVANI       | P    | P | P | P | P | P | P | P | P | P  | P  | P  | P  | P  | P  | P  | P  | P  | P  | P  |
| 19   | 16E31A0593 | NATTI SRILEKHA       | P    | P | P | P | P | P | P | P | P | P  | P  | P  | P  | P  | P  | P  | P  | P  | P  | P  |
| 20   | 16E31A05B3 | AKULA VARSHINI       | P    | P | P | P | P | P | P | P | P | P  | P  | P  | P  | P  | P  | P  | P  | P  | P  | P  |
| 21   | 16E31A05C7 | KODALI SAI KRISHNA   | P    | P | P | P | P | P | P | P | P | P  | P  | P  | P  | P  | P  | P  | P  | P  | P  | P  |
| 22   | 16E31A05F0 | VOJITALA MANASA      | P    | P | P | P | P | P | P | P | P | P  | P  | P  | P  | P  | P  | P  | P  | P  | P  | P  |
| 23   | 16E31A0306 | G VENU GOPAL         | P    | P | P | P | P | P | P | P | P | P  | P  | P  | P  | P  | P  | P  | P  | P  | P  | P  |
| 24   | 16E31A0313 | KOVA SAIKUMAR        | P    | P | P | P | P | P | P | P | P | P  | P  | P  | P  | P  | P  | P  | P  | P  | P  | P  |
| 25   | 16E31A0324 | NALLA TEJASWI        | P    | P | P | P | P | P | P | P | P | P  | P  | P  | P  | P  | P  | P  | P  | P  | P  | P  |

*M Ratibha*



**MAHAVEER INSTITUTE OF  
SCIENCE AND TECHNOLOGY**  
APPROVED BY AICTE AFFILIATED TO JNTUH - HYD.

DEPARTMENT OF  
HUMANITIES AND SCIENCES

## Certificate

This is to certify that Mr/Ms B BHAVYA SRI  
bearing Hall Ticket No 16E31A0407 of B.Tech First Year  
has participated In Certificate course on  
**ATOMIC STRUCTURE**

From 25-08-16 to 16-09-16

Organized by Dept. of Humanities and Sciences

*M Pratibha*

HOD  
Department of Humanities & Sciences  
Mahaveer Institute of Science & Technology  
HYDRABAD

*M. S. S. S.*

PRINCIPAL  
MAHAVEER INSTITUTE OF  
SCIENCE & TECHNOLOGY  
HYDRABAD, TELANGANA